

IBM XL Fortran for Linux, V15.1.5



Compiler Reference for Little Endian Distributions

Version 15.1.5

IBM XL Fortran for Linux, V15.1.5



Compiler Reference for Little Endian Distributions

Version 15.1.5

Note

Before using this information and the product it supports, read the information in "Notices" on page 343.

First edition

This edition applies to IBM XL Fortran for Linux, V15.1.5 (Program 5765-J10; 5725-C75) and to all subsequent releases and modifications until otherwise indicated in new editions. Make sure you are using the correct edition for the level of the product.

© Copyright IBM Corporation 1990, 2016.

US Government Users Restricted Rights – Use, duplication or disclosure restricted by GSA ADP Schedule Contract with IBM Corp.

Contents

About this document	vii
Who should read this document	vii
How to use this document	vii
How this document is organized	vii
Conventions	viii
Related information	xii
IBM XL Fortran information	xii
Standards and specifications	xiii
Other IBM information	xiv
Technical support	xiv
How to send your comments	xiv

Chapter 1. Introduction 1

Chapter 2. Overview of XL Fortran features 3

Hardware and operating-system support	3
Language support	3
Source-code conformance checking	4
Highly configurable compiler	4
Diagnostic listings	6
Symbolic debugger support	6
Program optimization	6

Chapter 3. Setting up and customizing XL Fortran 7

Where to find installation instructions	7
Correct settings for environment variables	7
Environment variable basics	7
Setting library search paths	8
Profile-directed feedback environment variables	8
TMPDIR: Specifying a directory for temporary files	9
XLFSCRATCH_unit: Specifying names for scratch files	9
XLFUNIT_unit: Specifying names for implicitly connected files	9
Using custom compiler configuration files	10
Creating custom configuration files	10
Using IBM XL Fortran for Linux, V15.1.5 with the Advance Toolchain	13
Editing the default configuration file	14
Configuration file attributes	14
Determining which level of XL Fortran is installed	17
Running two levels of XL Fortran	18

Chapter 4. Editing, compiling, linking, and running XL Fortran programs 19

Editing XL Fortran source files	19
Compiling XL Fortran programs	20
Compiling XL Fortran Version 2 programs	22
Compiling Fortran 90 or Fortran 95 programs	22
Compiling Fortran 2003 programs	23
Compiling Fortran 2008 programs	23

Compiling CUDA Fortran programs	23
Compiling and linking a library	24
Compiling XL Fortran SMP programs	25
Compilation order for Fortran programs	25
Canceling a compilation	25
XL Fortran input files	26
XL Fortran output files	27
Scope and precedence of option settings	29
Specifying options on the command line	29
Specifying options in the source file	30
Passing command-line options to the "ld" or "as" command	31
Displaying information inside binary files (strings)	31
Compiling for specific architectures	32
Passing Fortran files through the C preprocessor	32
cpp directives for XL Fortran programs	33
Passing options to the C preprocessor	34
Avoiding preprocessing problems	34
Linking XL Fortran programs	34
Compiling and linking in separate steps	35
Passing options to the ld command	35
Dynamic and static linking	35
Avoiding naming conflicts during linking	35
Running XL Fortran programs	36
Canceling execution	36
Compiling and executing on different systems	36
Runtime libraries for POSIX pthreads support	37
Setting runtime options	37
Other environment variables that affect runtime behavior	48
XL Fortran runtime exceptions	48

Chapter 5. Summary of compiler options by functional category 51

Output control	51
Input control	53
Language element control	54
Floating-point and integer control	56
Object code control	57
Error checking and debugging	58
Listings, messages, and compiler information	60
Optimization and tuning	62
Linking	65
Portability and migration	66
Compiler customization	67

Chapter 6. Detailed descriptions of the XL Fortran compiler options 69

-#	70
-1	71
-B	71
-C	72
-c	73
-D	73

-d	74	-qinfo	153
-e	74	-qinit	158
-F	75	-qinitalloc	158
-g	77	-qinitauto	160
-I	80	-qinlgue	163
-k	81	-qinline	163
-L	82	-qintlog	166
-l	82	-qintsize	167
-MF	83	-qipa	169
-MMD	84	-qkeepparm	174
-MT	85	-qlanglvl	175
-NS	86	-qlibansi	177
-O	87	-qlibmpi	178
-o	89	-qlinedebug	179
-p	90	-qlist	180
-qalias	91	-qlistfmt	181
-qalign	94	-qlistopt	184
-qaltivec	96	-qlog4	184
-qarch	97	-qmakedep	185
-qassert	99	-qmaxerr	188
-qattr	100	-qmaxmem	189
-qautodbl	101	-qmbcs	191
-qbindcextname	103	-qmixed	191
-qcache	104	-qmkshrobj	192
-qcclines	107	-qmoddir	193
-qcheck	107	-qnoprint	194
-qci	110	-qnullterm	194
-qcompact	111	-qobject	196
-qcr	112	-qoffload	197
-qctyplss	113	-qonetrip	198
-qcuda (CUDA Fortran)	114	-qoptfile	198
-qcudaerr (CUDA Fortran)	115	-qoptimize	200
-qdbg	117	-qpath	201
-qddim	118	-qpdf1, -qpdf2	202
-qdescriptor	119	-qphsinfo	207
-qdirective	120	-qpic	209
-qdirectstorage	122	-qport	209
-qdlines	123	-qposition	212
-qdpc	123	-qppsuborigarg	213
-qenum	124	-qprefetch	214
-qescape	125	-qqcount	216
-qessl	127	-qrealize	217
-qextern	128	-qrecur	219
-qextname	129	-qreport	220
-qfdpr	130	-qsa	222
-qfixed	131	-qsave	223
-qflag	132	-qsaveopt	224
-qfloat	134	-qsclk	226
-qfpp	137	-qshowpdf	227
-qfltrap	138	-qsigtrap	228
-qfree	140	-qsimd	229
-qfullpath	141	-qslmtags	230
-qfunctrace	142	-qsmallstack	231
-qfunctrace_xlf_catch	144	-qsmp	232
-qfunctrace_xlf_enter	145	-qsource	236
-qfunctrace_xlf_exit	146	-qspillsize	237
-qhalt	147	-qstackprotect	238
-qhaltormsg	148	-qstacktemp	239
-qhelp	149	-qstaticlink	240
-qhot	149	-qstrict	242
-qieee	152	-qstrictieemod	246

-qstrict_induction	247
-qsuffix	248
-qsuppress	249
-qswapomp	251
-qtbtable	252
-qthreaded	253
-qtimestamps	254
-qtune	255
-qufmt	257
-qundef	258
-qunroll	258
-qunwind	260
-qversion	260
-qvisibility	262
-qwarn64	263
-qxflag=dvz	264
-qxflag=oldtab	265
-qxf77	266
-qxf90	268
-qxf2003	270
-qxf2008	273
-qxlines	274
-qxref	276
-qzerosize	277
-r	277
-S	278
-t	279
-U	280
-u	281
-v	281
-V	282
-w	282
-W, -X	283
-y	285

Chapter 7. Compiler commands reference	287
cleanpdf	287
genhtml	288
mergepdf	288
showpdf	289

Chapter 8. Using XL Fortran in a 64-bit environment	293
--	------------

Chapter 9. Tracking compiler license usage.	295
Understanding compiler license tracking	295
Setting up SLM Tags logging	296

Chapter 10. Problem determination and debugging.	299
Understanding XL Fortran error messages.	299

Error severity	299
Compiler return codes	300
Runtime return codes	300
Format of XL Fortran diagnostic messages.	300
Limiting the number of compile-time messages	301
Fixing installation or system environment problems	301
Fixing compile-time problems	303
Fixing link-time problems	304
Fixing runtime problems	305
Debugging a Fortran program.	306

Chapter 11. Understanding XL Fortran compiler listings	307
Header section	307
Options section.	307
Source section	308
Error messages	308
PDF report section.	308
Transformation report section	309
Data reorganization report section	311
Attribute and cross reference section.	311
Object section	312
File table section	313
Compilation unit epilogue Section	313
Compilation epilogue Section	313

Chapter 12. XL Fortran technical information	315
External names in XL Fortran libraries	315
The XL Fortran runtime environment	315
External names in the runtime environment	315
Technical details of the -qfloat=hsflt option	316
Implementation details for -qautodbl promotion and padding	316
Terminology.	316
Examples of storage relationships for -qautodbl suboptions	317

Chapter 13. XL Fortran internal limits	321
---	------------

Glossary	323
---------------------------	------------

Notices	343
Trademarks	345

Index	347
------------------------	------------

About this document

This document describes the IBM® XL Fortran for Linux, V15.1.5 compiler and explains how to set up the compilation environment and how to compile, link, and run programs written in the Fortran language. This guide also contains cross-references to relevant topics of other reference guides in the XL Fortran documentation suite.

Who should read this document

This document is for anyone who wants to work with the IBM XL Fortran for Linux, V15.1.5 compiler, who is familiar with the Linux operating system, and who has some previous Fortran programming experience. Users new to XL Fortran can also find information about the capabilities and features unique to XL Fortran. This document can help you understand the compiler features, especially the options, and how to use them for effective software development.

How to use this document

While this document covers topics such as configuring the compiler, and compiling, linking, and running XL Fortran programs, it does not include the following information, which is covered in other documents:

- Installation, system requirements, last-minute updates: see the *XL Fortran Installation Guide* and product README file.
- Overview of XL Fortran features: see *Getting Started with XL Fortran*.
- Syntax, semantics, and implementation of the XL Fortran programming language: see the *XL Fortran Language Reference*.
- Optimizing, porting, OpenMP and SMP programming: see the *XL Fortran Optimization and Programming Guide*.
- Operating system commands related to the use of the compiler: consult the man page help and documentation of your Linux-specific distribution.

How this document is organized

This document starts with an overview of the compiler and then outlines the tasks you need to do before invoking the compiler. It then continues with reference information about the compiler options and debugging problems.

This reference includes the following topics:

- Chapter 1, “Introduction,” on page 1 through Chapter 4, “Editing, compiling, linking, and running XL Fortran programs,” on page 19 discuss setting up the compilation environment and the environment variables that you need for different compilation modes, customizing the configuration file, the types of input and output files, compiler listings and messages, and information specific to invoking the preprocessor and linkage editor.
- Chapter 5, “Summary of compiler options by functional category,” on page 51 organizes the compiler options by their functional category. You can search for options by their name, or alternatively use the functional category tables to look up and link to options.

- Chapter 6, “Detailed descriptions of the XL Fortran compiler options,” on page 69 includes individual descriptions of compiler options sorted alphabetically. Descriptions provide examples and list related topics.
- Chapter 7, “Compiler commands reference,” on page 287 provides detailed descriptions of the commands that are included in XL Fortran.
- Chapter 8, “Using XL Fortran in a 64-bit environment,” on page 293 discusses application development for the 64-bit environment.
- Chapter 9, “Tracking compiler license usage,” on page 295 discusses tracking compiler utilization. This chapter provides information that helps you to detect whether compiler utilization exceeds your floating user license entitlements.
- Chapter 10, “Problem determination and debugging,” on page 299 and Chapter 11, “Understanding XL Fortran compiler listings,” on page 307 address debugging and understanding compiler listings.
- Chapter 12, “XL Fortran technical information,” on page 315 and Chapter 13, “XL Fortran internal limits,” on page 321 provide information that advanced programmers might need to diagnose unusual problems and run the compiler in a specialized environment.

Conventions

Typographical conventions

The following table shows the typographical conventions used in the IBM XL Fortran for Linux, V15.1.5 information.













Table 1. *Typographical conventions*

Typeface	Indicates	Example
lowercase bold	Invocation commands, executable names, and compiler options.	The compiler provides basic invocation commands, xlf , along with several other compiler invocation commands to support various Fortran language levels and compilation environments. The default file name for the executable program is a.out .
<i>italics</i>	Parameters or variables whose actual names or values are to be supplied by the user. Italics are also used to introduce new terms.	Make sure that you update the <i>size</i> parameter if you return more than the <i>size</i> requested.
<u>underlining</u>	The default setting of a parameter of a compiler option or directive.	nomaf <u>maf</u>
monospace	Examples of program code, reference to program code, file names, path names, command strings, or user-defined names.	To compile and optimize myprogram.f, enter: xlf myprogram.f -03.
UPPERCASE bold	Fortran programming keywords, statements, directives, and intrinsic procedures. Uppercase letters may also be used to indicate the minimum number of characters required to invoke a compiler option/suboption.	The ASSERT directive applies only to the DO loop immediately following the directive, and not to any nested DO loops.

Qualifying elements (icons and bracket separators)

In descriptions of language elements or programming models, this information uses icons and marked bracket separators to delineate segments of text as follows:

Table 2. Qualifying elements







Icon	Bracket separator text	Meaning
 	Fortran 2008 begins / Fortran 2008 ends	The text describes an IBM XL Fortran implementation of the Fortran 2008 standard. ¹
 	Fortran 2003 begins / Fortran 2003 ends	The text describes an IBM XL Fortran implementation of the Fortran 2003 standard, and it applies to all later standards. ¹
 	TS 29113 begins / TS 29113 ends	The text describes an IBM XL Fortran implementation of Technical Specification 29113, referred to as TS 29113. ¹
 	IBM extension begins / IBM extension ends	The text describes a feature that is an IBM XL Fortran extension to the standard language specifications.
 	CUDA Fortran begins / CUDA Fortran ends	The text describes CUDA Fortran, the CUDA Fortran support provided by IBM XL Fortran, or both.
 	GPU begins / GPU ends	The text describes the information that is relevant to offloading computations to the NVIDIA GPUs.

Note:

1. If the information is marked with a Fortran language standard icon or bracket separators, it applies to this specific Fortran language standard and all later ones. Otherwise, it applies to all Fortran language standards.

Syntax diagrams

Throughout this information, diagrams illustrate XL Fortran syntax. This section helps you to interpret and use those diagrams.

- Read the syntax diagrams from left to right, from top to bottom, following the path of the line.
 - The  symbol indicates the beginning of a command, directive, or statement.
 - The  symbol indicates that the command, directive, or statement syntax is continued on the next line.
 - The  symbol indicates that a command, directive, or statement is continued from the previous line.
 - The  symbol indicates the end of a command, directive, or statement.
- Fragments, which are diagrams of syntactical units other than complete commands, directives, or statements, start with the  symbol and end with the  symbol.

IBM XL Fortran extensions are marked by a number in the syntax diagram with an explanatory note immediately following the diagram.

Program units, procedures, constructs, interface blocks and derived-type definitions consist of several individual statements. For such items, a box encloses the syntax representation, and individual syntax diagrams show the required order for the equivalent Fortran statements.

- Required items are shown on the horizontal line (the main path):

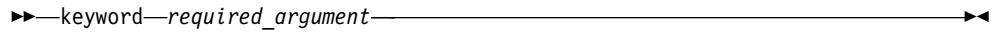

- Optional items are shown below the main path:



Note: Optional items (not in syntax diagrams) are enclosed by square brackets ([and]). For example, [UNIT=]u

- If you can choose from two or more items, they are shown vertically, in a stack. If you *must* choose one of the items, one item of the stack is shown on the main path.

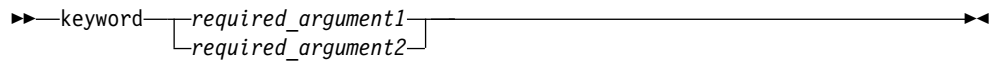

If choosing one of the items is optional, the entire stack is shown below the main path.



- An arrow returning to the left above the main line (a repeat arrow) indicates that you can make more than one choice from the stacked items or repeat an item. The separator character, if it is other than a blank, is also indicated:



- The item that is the default is shown above the main path.



- Keywords are shown in nonitalic letters and should be entered exactly as shown.
- Variables are shown in italicized lowercase letters. They represent user-supplied names or values. If a variable or user-specified name ends in *_list*, you can provide a list of these terms separated by commas.
- If punctuation marks, parentheses, arithmetic operators, or other such symbols are shown, you must enter them as part of the syntax.

Sample syntax diagram

The following is an example of a syntax diagram with an interpretation:

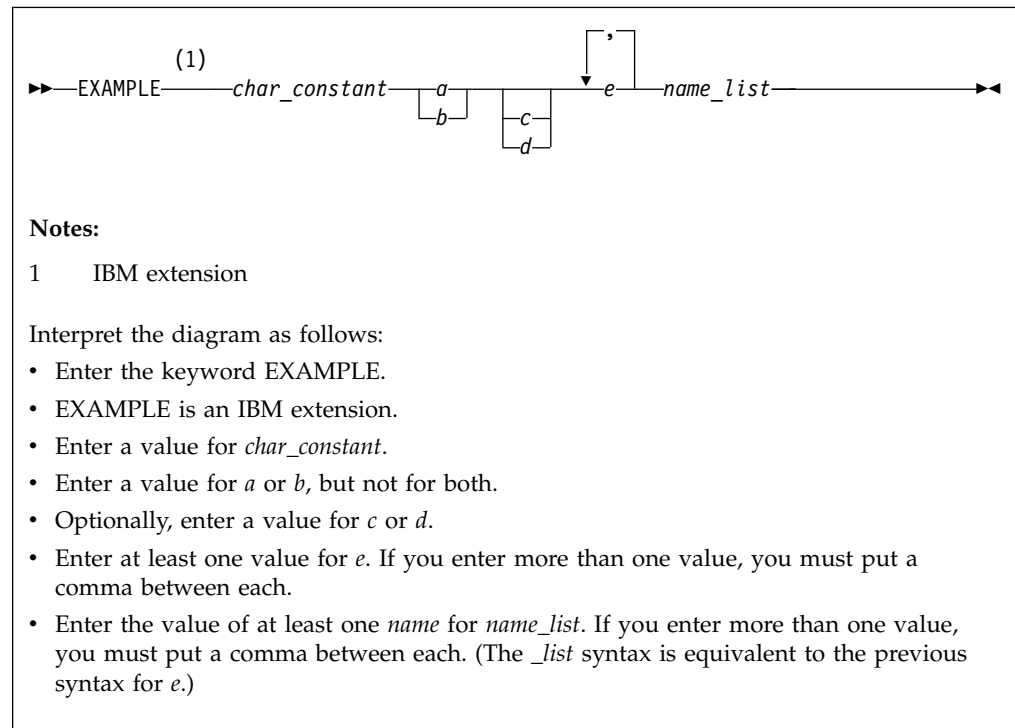

How to read syntax statements

Syntax statements are read from left to right:

- Individual required arguments are shown with no special notation.
- When you must make a choice between a set of alternatives, they are enclosed by { and } symbols.
- Optional arguments are enclosed by [and] symbols.
- When you can select from a group of choices, they are separated by | characters.
- Arguments that you can repeat are followed by ellipses (...).

Example of a syntax statement

EXAMPLE *char_constant* { *a* | *b* } { *c* | *d* } *e* [, *e*] ... *name_list* { *name_list* } ...

The following list explains the syntax statement:

- Enter the keyword EXAMPLE.
- Enter a value for *char_constant*.
- Enter a value for *a* or *b*, but not for both.
- Optionally, enter a value for *c* or *d*.
- Enter at least one value for *e*. If you enter more than one value, you must put a comma between each.
- Optionally, enter the value of at least one *name* for *name_list*. If you enter more than one value, you must put a comma between each *name*.

Note: The same example is used in both the syntax-statement and syntax-diagram representations.

Examples in this information

The examples in this information, except where otherwise noted, are coded in a simple style that does not try to conserve storage, check for errors, achieve fast performance, or demonstrate all possible methods to achieve a specific result.

The examples for installation information are labelled as either *Example* or *Basic example*. *Basic examples* are intended to document a procedure as it would be performed during a basic, or default, installation; these need little or no modification.

Notes on the terminology used

Some of the terminology in this information is shortened as follows:

- The term *free source form format* often appears as *free source form*.
- The term *fixed source form format* often appears as *fixed source form*.
- The term *XL Fortran* often appears as *XLF*.

Related information

The following sections provide related information for XL Fortran:

IBM XL Fortran information

XL Fortran provides product information in the following formats:

- Quick Start Guide

The Quick Start Guide (`quickstart.pdf`) is intended to get you started with IBM XL Fortran for Linux, V15.1.5. It is located by default in the XL Fortran directory and in the `\quickstart` directory of the installation DVD.

- README files

README files contain late-breaking information, including changes and corrections to the product information. README files are located by default in the XL Fortran directory, and in the root directory and subdirectories of the installation DVD.

- Installable man pages

Man pages are provided for the compiler invocations and all command-line utilities provided with the product. Instructions for installing and accessing the man pages are provided in the *IBM XL Fortran for Linux, V15.1.5 Installation Guide*.

- Online product documentation

The fully searchable HTML-based documentation is viewable in IBM Knowledge Center at http://www.ibm.com/support/knowledgecenter/SSAT4T_15.1.5/com.ibm.compilers.linux.doc/welcome.html.

- PDF documents

PDF documents are available on the web at <http://www.ibm.com/support/docview.wss?uid=swg27036672>.

The following files comprise the full set of XL Fortran product information:

Table 3. XL Fortran PDF files

Document title	PDF file name	Description
<i>IBM XL Fortran for Linux, V15.1.5 Installation Guide, GC27-6580-04</i>	install.pdf	Contains information for installing XL Fortran and configuring your environment for basic compilation and program execution.
<i>Getting Started with IBM XL Fortran for Linux, V15.1.5, SC27-6620-04</i>	getstart.pdf	Contains an introduction to the XL Fortran product, with information about setting up and configuring your environment, compiling and linking programs, and troubleshooting compilation errors.
<i>IBM XL Fortran for Linux, V15.1.5 Compiler Reference, SC27-6610-04</i>	compiler.pdf	Contains information about the various compiler options and environment variables.
<i>IBM XL Fortran for Linux, V15.1.5 Language Reference, SC27-6590-04</i>	langref.pdf	Contains information about the Fortran programming language as supported by IBM, including language extensions for portability and conformance to nonproprietary standards, compiler directives and intrinsic procedures.
<i>IBM XL Fortran for Linux, V15.1.5 Optimization and Programming Guide, SC27-6600-04</i>	proguide.pdf	Contains information on advanced programming topics, such as application porting, interlanguage calls, floating-point operations, input/output, application optimization and parallelization, and the XL Fortran high-performance libraries.
<i>Getting Started with CUDA Fortran programming using IBM XL Fortran for Linux, V15.1.5, GI13-3562-01</i>	getstart_cudaf.pdf	Contains detailed information about the CUDA Fortran support that is provided in XL Fortran, including the compiler flow for CUDA Fortran programs, compilation commands, useful compiler options and macros, supported CUDA Fortran features, and limitations.

To read a PDF file, use Adobe Reader. If you do not have Adobe Reader, you can download it (subject to license terms) from the Adobe website at <http://www.adobe.com>.

More information related to XL Fortran, including IBM Redbooks® publications, white papers, and other articles, is available on the web at <http://www.ibm.com/support/docview.wss?uid=swg27036672>.

For more information about the compiler, see the XL compiler on Power® community at <http://ibm.biz/xl-power-compilers>.

Standards and specifications

XL Fortran is designed to support the following standards and specifications. You can refer to these standards and specifications for precise definitions of some of the features found in this information.

- *American National Standard Programming Language FORTRAN, ANSI X3.9-1978.*
- *American National Standard Programming Language Fortran 90, ANSI X3.198-1992.*
- *ANSI/IEEE Standard for Binary Floating-Point Arithmetic, ANSI/IEEE Std 754-1985.*
- *Federal (USA) Information Processing Standards Publication Fortran, FIPS PUB 69-1.*

- *Information technology - Programming languages - Fortran, ISO/IEC 1539-1:1991.* (This information uses its informal name, Fortran 90.)
- *Information technology - Programming languages - Fortran - Part 1: Base language, ISO/IEC 1539-1:1997.* (This information uses its informal name, Fortran 95.)
- *Information technology - Programming languages - Fortran - Part 1: Base language, ISO/IEC 1539-1:2004.* (This information uses its informal name, Fortran 2003.)
- *Information technology - Programming languages - Fortran - Part 1: Base language, ISO/IEC 1539-1:2010.* (This information uses its informal name, Fortran 2008. We currently provide partial support to this standard.)
- *Information technology - Further interoperability of Fortran with C, ISO/IEC TS 29113:2012.* (This information uses its informal name, Technical specification 29113, referred to as TS 29113. We currently provide partial support to this specification.)
- *Military Standard Fortran DOD Supplement to ANSI X3.9-1978, MIL-STD-1753* (United States of America, Department of Defense standard). Note that XL Fortran supports only those extensions documented in this standard that have also been subsequently incorporated into the Fortran 90 standard.
- *OpenMP Application Program Interface Version 3.1 (full support), OpenMP Application Program Interface Version 4.0 (partial support), and OpenMP Application Program Interface Version 4.5 (partial support),* available at <http://www.openmp.org>

Other IBM information

- *ESSL product documentation* available at http://www.ibm.com/support/knowledgecenter/SSFHY8/essl_welcome.html?lang=en

Technical support

Additional technical support is available from the XL Fortran Support page at http://www.ibm.com/support/entry/portal/product/rational/xl_fortran_for_linux. This page provides a portal with search capabilities to a large selection of Technotes and other support information.

If you cannot find what you need, you can send an email to compinfo@ca.ibm.com.

For the latest information about XL Fortran, visit the product information site at <http://ibm.biz/xlfortran-linux>.

How to send your comments

Your feedback is important in helping us to provide accurate and high-quality information. If you have any comments about this information or any other XL Fortran information, send your comments to compinfo@ca.ibm.com.

Be sure to include the name of the manual, the part number of the manual, the version of XL Fortran, and, if applicable, the specific location of the text you are commenting on (for example, a page number or table number).

Chapter 1. Introduction

IBM XL Fortran for Linux, V15.1.5 is an optimizing, standards-based, command-line compiler for the Linux operating system, running on Power hardware with the Power Architecture. The XL Fortran compiler enables application developers to create and maintain optimized 64-bit applications for the Linux operating system. The compiler also offers a diversified portfolio of optimization techniques that allow an application developer to exploit the multi-layered architecture of the Power processor.

The implementation of the Fortran programming language is intended to promote portability among different environments by enforcing conformance to language standards. A program that conforms strictly to its language specification has maximum portability among different environments. In theory, a program that compiles correctly with one standards-conforming compiler will compile and execute correctly under all other conforming compilers, insofar as hardware differences permit. A program that correctly exploits the extensions to the programming language in which it is written can improve the efficiency of its object code.

XL Fortran can be used for large, complex, and computationally intensive programs. It also supports interlanguage calls with C. For applications that require SIMD (single-instruction, multiple data) parallel processing, performance improvements can be achieved through optimization techniques, which may be less labor-intensive than vector programming. Many of the optimizations developed by IBM are controlled by compiler options and directives.

You can use the CUDA Fortran support provided by XL Fortran to take full advantage of any NVIDIA GPUs in your system.

Chapter 2. Overview of XL Fortran features

This section discusses the features of the XL Fortran compiler, language, and development environment at a high level. It is intended for people who are evaluating XL Fortran and for new users who want to find out more about the product.

Hardware and operating-system support

IBM XL Fortran for Linux, V15.1.5 is supported on several Linux distributions.

See the *XL Fortran for Linux Installation Guide* and README file for a list of supported distributions and requirements.

The compiler, its generated object programs, and runtime library can run on POWER8[®] systems with the required software, disk space, and virtual storage.

The POWER8 processors are types of PowerPC[®] processors. In this document, any statement or reference to the PowerPC processor also applies to the POWER8 processors.

To take maximum advantage of different hardware configurations, the compiler provides a number of options for performance tuning based on the configuration of the machine used for executing an application.

Language support

This topic lists languages and language extensions that are supported by XL Fortran.

The XL Fortran language consists of the following:

- Partial ISO Technical specification 29113 support (referred to as TS 29113), defined in the document *Information technology -- Further interoperability of Fortran with C, ISO/IEC TS 29113:2012*.
- Partial ISO Fortran 2008 language standard (referred to as Fortran 2008 or F2008), defined in the document *Information technology - Programming languages - Part 1: Base language, ISO/IEC 1539-1:2010*.
- The full ISO Fortran 2003 language standard (referred to as Fortran 2003 or F2003), defined in the document *Information technology - Programming languages - Part 1: Base language, ISO/IEC 1539-1:2004*.
- The full ISO Fortran 95 language standard (referred to as Fortran 95 or F95), defined in the document *Information technology - Programming languages - Fortran - Part 1: Base language, ISO/IEC 1539-1:1997*.
- The full American National Standard Fortran 90 language (referred to as Fortran 90 or F90), defined in the documents *American National Standard Programming Language Fortran 90, ANSI X3.198-1992* and *Information technology - Programming languages - Fortran, ISO/IEC 1539-1:1991 (E)*. This language has a superset of the features found in the FORTRAN 77 standard. It adds many more features that are intended to shift more of the tasks of error checking, array processing, memory allocation, and so on from the programmer to the compiler.
- Extensions to the Fortran standard:

- Common Fortran language extensions defined by other compiler vendors, in addition to those defined by IBM
- Industry extensions that are found in Fortran products from various compiler vendors
- Extensions specified in SAA Fortran
- Extensions of the Vector Multimedia Extension (VMX) and the Vector Scalar Extension (VSX) intrinsic functions

In the *XL Fortran Language Reference*, extensions to the Fortran 2003 language and Fortran 2008 language are marked as described in the *Conventions: Qualifying elements* section.

Source-code conformance checking

To help you find possible problems when you port your application to or from different FORTRAN 77, Fortran 90, Fortran 95, Fortran 2003, or Fortran 2008 standards, the XL Fortran compiler provides options to warn you about features that no longer conform to certain Fortran definitions.

If you specify the appropriate compiler options, the XL Fortran compiler checks source statements for conformance to the following Fortran language definitions:

- Partial Fortran 2008 Standard (**-qlanglvl=2008std** option)
- Full Fortran 2003 Standard (**-qlanglvl=2003std** option)
- Full Fortran 95 Standard (**-qlanglvl=95std** option)
- Full American National Standard Fortran 90 Standard (**-qlanglvl=90std** option)
- Full American National Standard FORTRAN 77 Standard (**-qlanglvl=77std** option)
- Fortran 2008, less any obsolescent features (**-qlanglvl=2008pure** option)
- Fortran 2003, less any obsolescent features (**-qlanglvl=2003pure** option)
- Fortran 95, less any obsolescent features (**-qlanglvl=95pure** option)
- Fortran 90, less any obsolescent features (**-qlanglvl=90pure** option)
- Partial support for Technical Specification 29113 for further interoperability with C (**-qlanglvl=ts** option)
- Technical Specification 29113 supplements to Fortran 2008, less any obsolescent features (**-qlanglvl=tspure** option)
- IBM SAA FORTRAN (**-qsaa** option)

You can also use the **langlvl** option for conformance checking.



Note: Fortran 2008 conformance checking is based on the current subset implementation of this standard.

Highly configurable compiler

This topic provides information about the commands that you can use to invoke the compiler.

You can invoke the compiler by using the following commands:



- xlf
- xlf_r
- f77
- fort77
- xlf90

- xlf90_r
- f90
- xlf95
- xlf95_r
- f95
- xlf2003
- xlf2003_r
- f2003
- xlf2008
- xlf2008_r
- f2008
-  xlcuf 

The following commands maintain maximum compatibility with the behavior and I/O formats of XL Fortran Version 2:

- For `.f`, `.F`, `.f77` and `.F77` files: `xlf` and `xlf_r`
- For any source files: `f77` and `fort77`

Table 4. Features of nongeneric invocation commands

Commands	Features
<code>f77</code> and <code>fort77</code>	Provide maximum compatibility with the XPG4 behavior
<code>xlf90</code> , <code>xlf90_r</code> , and <code>f90</code>	Provide more Fortran 90 conformance and some implementation choices for efficiency and usability
<code>f95</code> , <code>xlf95</code> and <code>xlf95_r</code>	Provide more Fortran 95 conformance and some implementation choices for efficiency and usability
<code>xlf2003</code> , <code>xlf2003_r</code> , and <code>f2003</code>	Provide more Fortran 2003 conformance and some implementation choices for efficiency and usability
<code>xlf2008</code> , <code>xlf2008_r</code> , and <code>f2008</code>	Provide more Fortran 2008 conformance and some implementation choices for efficiency and usability
 <code>xlcuf</code>	Provides CUDA Fortran support 

The main difference between the set of `xlf_r`, `xlf90_r`, `xlf95_r`, `xlf2003_r`, and `xlf2008_r` commands and the set of `xlf`, `xlf90`, `f90`, `xlf95`, `f95`, `xlf2003`, `f2003`, `xlf2008`, `f2008`, `f77`, and `fort77` commands is that the first set links and binds the object files to the threadsafe components (libraries, and so on). You can have this behavior with the second set of commands by using the `-F` compiler option to specify the configuration file stanza to use. For example:

```
xlf -F/opt/ibm/xlf/15.1.5/etc/xlf.cfg:xlf_r
```

You can control the actions of the compiler through a set of options. The different categories of options help you to debug, to optimize and tune program performance, to select extensions for compatibility with programs from other platforms, and to do other common tasks that would otherwise require changing the source code.

To simplify the task of managing many different sets of compiler options, you can edit the default configuration file or use a customized configuration file instead of creating many separate aliases or shell scripts.

Related information

- “Using custom compiler configuration files” on page 10
- “Compiling XL Fortran programs” on page 20
- Chapter 5, “Summary of compiler options by functional category,” on page 51 and Chapter 6, “Detailed descriptions of the XL Fortran compiler options,” on page 69

Diagnostic listings

The compiler output listing has optional sections that you can include or omit.

For information about the applicable compiler options and the listing itself, see “Listings, messages, and compiler information” on page 60 and Chapter 11, “Understanding XL Fortran compiler listings,” on page 307.

The **-S** option gives you a true assembler source file.

Symbolic debugger support

You can instruct XL Fortran to include debugging information in your compiled objects by using different levels of the **-g** or **-qdbg** compiler option.

For details, see **-g** or **-qdbg**.

The debugging information can be examined by **gdb** or any other symbolic debugger to help you debug your programs.

Program optimization

The XL Fortran compiler helps you control the optimization of your programs in a number of ways.

- You can select different levels of compiler optimizations.
- You can turn on separate optimizations for loops, floating point, and other categories.
- You can optimize a program for a particular class of machines or for a very specific machine configuration, depending on where the program will run.

The *XL Fortran Optimization and Programming Guide* provides a road map and optimization strategies for these features.

Chapter 3. Setting up and customizing XL Fortran

This section explains how to customize XL Fortran settings for yourself or all users. The full installation procedure is beyond the scope of this section, which refers you to the documents that cover the procedure in detail.

This section can also help you to diagnose problems that relate to installing or configuring the compiler.

Some of the instructions require you to be a superuser, and so they are only applicable if you are a system administrator.

Where to find installation instructions

To install the compiler, refer to these documents (preferably in this order):

1. Read the file called `README.FIRST` in the root of the product tarball or DVD, and follow any directions it gives. It contains information that you must know and possibly distribute to other people who use XL Fortran.
2. Read the *XL Fortran Installation Guide* to see if there are any important notices you need to be aware of or any updates you might need to apply to your system before doing the installation.

Using default installation tools

- You should be familiar with the RPM Package Manager (RPM) for installing this product on SLES, RHEL, or CentOS. For information on using RPM, visit the RPM Web page at URL <http://www.rpm.org/>, or type `rpm --help` at the command line.

If you are already experienced with software installation, you can use the `rpm` command to install all the images from the distribution medium.

- You should be familiar with the Debian Package Manager (dpkg) for installing this product on Ubuntu. For information on using dpkg, you can view the dpkg man page at URL <http://manpages.ubuntu.com/manpages/trusty/en/man1/dpkg.1.html>, or type `dpkg --help` at the command line.

Correct settings for environment variables

You can set and export a number of environment variables for use with the operating system. The following sections deal with the environment variables that have special significance to the XL Fortran compiler, application programs, or both.

Environment variable basics

You can set the environment variables from shell command lines or from within shell scripts. (For more information about setting environment variables, see the man page help for the shell you are using.) If you are not sure which shell is in use, a quick way to find out is to issue `echo $SHELL` to show the name of the current shell.

To display the contents of an environment variable, enter the command `echo $var_name`.

Note: For the remainder of this document, most examples of shell commands use **Bash** notation instead of repeating the syntax for all shells.

Setting library search paths

If your executable program is linked with shared libraries, you must set the runtime library search paths. You can use one of the following three ways to set runtime library search paths:

- When linking the shared library into the executable, use the **-R** (or **-rpath**) compiler/link option.
- Before linking the shared library into the executable, set the **LD_RUN_PATH** environment variable.
- Set the **LD_LIBRARY_PATH** environment variable.

For example:

```
# Compile and link
xlf95 -L/usr/lib/mydir1 -R/usr/lib/mydir1 -L/usr/lib/mydir2 -R/usr/lib/mydir2
      -lmylib1 -lmylib2 test.f

# -L directories are searched at link time for both static and shared libraries.
# -R directories are searched at run time for shared libraries.
```

For more information about the linker option **-R** (or **-rpath**), and environment variables **LD_RUN_PATH** and **LD_LIBRARY_PATH**, see the man pages for the **ld** command.

Profile-directed feedback environment variables

The following list includes profile-directed feedback (PDF) environment variables that you can use with the **-qpdf** compiler option:

PDF_BIND_PROCESSOR

If you want to bind your application to the specified processor for cache-miss profiling, set the **PDF_BIND_PROCESSOR** environment variable. Processor 0 is set by default.

PDF_PM_EVENT

When you run an application compiled with **-qpdf1=level=2** and want to gather different levels of cache-miss profiling information, set the **PDF_PM_EVENT** environment variable to **L1MISS**, **L2MISS**, or **L3MISS** (if applicable) accordingly.

PDF_SIGNAL_TO_DUMP

If you want to enable dumping snapshot PDF profiling information to files during execution, you must define the **PDF_SIGNAL_TO_DUMP** environment variable before running the application. The value must be an integer in the range of **SIGRTMIN** and **SIGRTMAX** inclusive. For more information, see "Dumping snapshot PDF profiling information to files during execution" in the *XL Fortran Optimization and Programming Guide*.

PDF_WL_ID

The **PDF_WL_ID** environment variable is used to distinguish the sets of PDF counters that are generated by multiple training runs of the user program. Each run receives distinct input.

By default, PDF counters for training runs after the first training run are added to the first and the only set of PDF counters. This behavior can be changed by setting the **PDF_WL_ID** environment variable before each PDF training run. You can set **PDF_WL_ID** to an integer value in the range 1 -

65535. The PDF run time then uses this number to tag the set of PDF counters that are generated by this training run. After all the training runs complete, the PDF profile file contains multiple sets of PDF counters, each set with an ID number.

PDFDIR

When you compile a Fortran program with the **-qpdf** compiler option, you can specify the directory where profiling information is stored by setting the PDFDIR environment variable to the name of the directory. The compiler creates files to hold the profile information. XL Fortran updates the files when you run an application that is compiled with the **-qpdf1** option.

Problems can occur if the profiling information is stored in a wrong place or is updated by more than one application. To avoid these problems, you must follow these guidelines:

- Always set the PDFDIR environment variable when using the **-qpdf** option. Make sure that the directory specified by the PDFDIR environment variable exists; otherwise, the compiler issues a warning message.
- Store the profiling information for each application in a different directory, or use the **-qpdf1=pdfname**, **-qpdf1=exename** option to explicitly name the temporary profiling files according to the template provided.
- Leave the value of the PDFDIR environment variable unchanged until you have completed the PDF process (compiling, running, and compiling again) for the application.

TMPDIR: Specifying a directory for temporary files

The XL Fortran compiler creates a number of temporary files for use during compilation. An XL Fortran application program creates a temporary file at run time for a file opened with **STATUS='SCRATCH'**. By default, these files are placed in the directory **/tmp**.

If you want to change the directory where these files are placed, perhaps because **/tmp** is not large enough to hold all the temporary files, set and export the **TMPDIR** environment variable before running the compiler or the application program.

If you explicitly name a scratch file by using the **XLFSCRATCH_unit** method described below, the **TMPDIR** environment variable has no effect on that file.

XLFSCRATCH_unit: Specifying names for scratch files

To give a specific name to a scratch file, you can set the runtime option **scratch_vars=yes**; then set one or more environment variables with names of the form **XLFSCRATCH_unit** to file names to use when those units are opened as scratch files. See *Naming scratch files* in the *XL Fortran Optimization and Programming Guide* for examples.

XLFUNIT_unit: Specifying names for implicitly connected files

To give a specific name to an implicitly connected file or a file opened with no **FILE=** specifier, you can set the runtime option **unit_vars=yes**; then set one or more environment variables with names of the form **XLFUNIT_unit** to file names. See *Naming files that are connected with no explicit name* in the *XL Fortran Optimization and Programming Guide* for examples.

Using custom compiler configuration files

The XL Fortran compiler generates a default configuration file `/opt/ibm/xlf/15.1.5/etc/xlf.cfg.$OSRelease.gcc$gccVersion` at installation time. (See the *XL Fortran Installation Guide* for more information on the various tools you can use to generate the configuration file during installation.) The configuration file specifies information that the compiler uses when you invoke it. Examples of the default configuration file are listed below:

- `/opt/ibm/xlf/15.1.5/etc/xlf.cfg.sles.12.gcc.4.8.2`
- `/opt/ibm/xlf/15.1.5/etc/xlf.cfg.rhel.7.3.gcc.4.8.5`
- `/opt/ibm/xlf/15.1.5/etc/xlf.cfg.centos.7.gcc.4.8.3`
- `/opt/ibm/xlf/15.1.5/etc/xlf.cfg.ubuntu.16.04.gcc.4.8.2`

If you are running on a single-user system, or if you already have a compilation environment with compilation scripts or makefiles, you might want to leave the default configuration file as it is.

If you want users to be able to choose among several sets of compiler options, you might want to use custom configuration files for specific needs. For example, you might want to enable `-qlist` by default for compilations using the `xlf` compiler invocation command. This is to avoid forcing your users to specify this option on the command line for every compilation, because `-qnolist` is automatically in effect every time the compiler is called with the `xlf` command.

You have several options for customizing configuration files:

- You can directly edit the default configuration file. In this case, the customized options will apply for all users for all compilations. The disadvantage of this option is that you will need to reapply your customizations to the new default configuration file that is provided every time you install a compiler update.
- You can use the default configuration file as the basis of customized copies that you specify at compile time with the `-F` option. In this case, the custom file overrides the default file on a per-compilation basis.

Note: This option requires you to reapply your customization after you apply service to the compiler.

- You can create custom, or user-defined, configuration files that are specified at compile time with the `XLF_USR_CONFIG` environment variable. In this case, the custom user-defined files complement, rather than override, the default configuration file, and they can be specified on a per-compilation or global basis. The advantage of this option is that you do not need to modify your existing, custom configuration files when a new system configuration file is installed during an update installation. Procedures for creating custom, user-defined configuration files are provided below.

Related reference:

“-F” on page 75

Creating custom configuration files

If you use the `XLF_USR_CONFIG` environment variable to instruct the compiler to use a custom user-defined configuration file, the compiler examines and processes the settings in that user-defined configuration file before looking at the settings in the default system configuration file.

To create a custom user-defined configuration file, you add stanzas which specify multiple levels of the **use** attribute. The user-defined configuration file can reference definitions specified elsewhere in the same file, as well as those specified in the system configuration file. For a given compilation, when the compiler looks for a given stanza, it searches from the beginning of the user-defined configuration file and follows any other stanza named in the use attribute, including those specified in the system configuration file.

If the stanza named in the **use** attribute has a name different from the stanza currently being processed, the search for the use stanza starts from the beginning of the user-defined configuration file. This is the case for stanzas A, C, and D which you see in the following example. However, if the stanza in the **use** attribute has the same name as the stanza currently being processed, as is the case of the two B stanzas in the example, the search for the **use** stanza starts from the location of the current stanza.

The following example shows how you can use multiple levels for the **use** attribute. This example uses the **options** attribute to help show how the **use** attribute works, but any other attributes, such as **libraries** can also be used.

```
A: use =DEFLT
   options=<set of options A>
B: use =B
   options=<set of options B1>
B: use =D
   options=<set of options B2>
C: use =A
   options=<set of options C>
D: use =A
   options=<set of options D>
DEFLT:
   options=<set of options Z>
```

Figure 1. Sample configuration file

In this example:

- stanza A uses option sets A and Z
- stanza B uses option sets B1, B2, D, A, and Z
- stanza C uses option sets C, A, and Z
- stanza D uses option sets D, A, and Z

Attributes are processed in the same order as the stanzas. The order in which the options are specified is important for option resolution. Ordinarily, if an option is specified more than once, the last specified instance of that option wins.

By default, values defined in a stanza in a configuration file are added to the list of values specified in previously processed stanzas. For example, assume that the XLF_USR_CONFIG environment variable is set to point to the user-defined configuration file at ~/userconfig1. With the user-defined and default configuration files shown in the following example, the compiler references the **xlf** stanza in the configuration files in the following order: A1, A, D, and C.

```

xlf: use=xlf
      options= <A1>

DEFLT: use=DEFLT
        options=<D>

```

```

xlf: use=DEFLT
      options=<A>

DEFLT:
      options=<C>

```

Figure 2. Custom user-defined configuration file ~/userconfig1 Figure 3. Default configuration file xlf.cfg

Overriding the default order of attribute values

You can override the default order of attribute values by changing the assignment operator(=) for any attribute in the configuration file.

Table 5. Assignment operators and attribute ordering

Assignment Operator	Description
--	Prepend the following values before any values determined by the default search order.
:=	Replace any values determined by the default search order with the following values.
+=	Append the following values after any values determined by the default search order.

For example, assume that the XLF_USR_CONFIG environment variable is set to point to the custom user-defined configuration file at ~/userconfig2.

Custom user-defined configuration file

~/userconfig2

```

xlf_prepend: use=xlf
              options--<B1>
xlf_replace: use=xlf
              options:=<B2>
xlf_append:  use=xlf
              options+=<B3>

```

```

DEFLT: use=DEFLT
        options=<D>

```

Default configuration file xlf.cfg

```

xlf: use=DEFLT
      options=<B>

DEFLT:
      options=<C>

```

The stanzas in the preceding configuration files use the following option sets, in the following orders:

1. stanza xlf uses B, D, and C
2. stanza xlf_prepend uses B1, B, D, and C
3. stanza xlf_replace uses B2
4. stanza xlf_append uses B, D, C, and B3

You can also use assignment operators to specify an attribute more than once. For example:

```

xlf:
  use=xlf
  options--=Isome_include_path
  options+=some options

```

Figure 4. Using additional assignment operations

Examples of stanzas in custom configuration files

<pre> DEFLT: use=DEFLT options = -g </pre>	<p>This example specifies that the -g option is to be used in all compilations.</p>
<pre> xlf: use=xlf options+==qlist xlf_r: use=xlf_r options+==qlist </pre>	<p>This example specifies that -qlist is to be used for any compilation called by the xlf and xlf_r commands. This -qlist specification overrides the default setting of -qlist specified in the system configuration file.</p>
<pre> DEFLT: use=DEFLT libraries=-L/home/user/lib,-lmylib </pre>	<p>This example specifies that all compilations should link with <code>/home/user/lib/libmylib.a</code>.</p>

Using IBM XL Fortran for Linux, V15.1.5 with the Advance Toolchain

IBM XL Fortran for Linux, V15.1.5 supports IBM Advance Toolchain 9.0, which is a set of open source development tools and runtime libraries. With IBM Advance Toolchain 9.0, you can take advantage of the latest POWER® hardware features on Linux, especially the tuned libraries. For more information about the Advance Toolchain 9.0, see IBM Advance Toolchain for PowerLinux™ Documentation.

To use IBM XL Fortran for Linux, V15.1.5 with the Advance Toolchain, take the following steps:

1. Install the **at9.0** packages into the default installation location. For instructions, see IBM Advance Toolchain for PowerLinux Documentation.
2. Run the **xlf_configure** utility to create the **xlf.at.cfg** configuration file. In the **xlf.at.cfg** configuration file, all other entities except the XL Fortran compiler are directed to those of the Advance Toolchain. The entities include the linker, headers, and runtime libraries.

Note: To run the **xlf_configure** utility, you must either become the root user or use the **sudo** command.

- If you installed the compiler in the default location, issue the following command:

```
xlf_configure -at
```
- If you installed the compiler in a nondefault installation (NDI) location, issue the following command:

```
xlf_configure -at -ibmcmp $ndi_path
```

where *\$ndi_path* is the directory in which you installed the compiler.

3. Invoke the XL compiler with the Advance Toolchain support.
 - If you installed the compiler in the default location, issue the following command:

```
/opt/ibm/xlf/15.1.5/bin/xlf_at
```

- If you installed the compiler in an NDI location, issue the following command:

```
$ndi_path/xlf/15.1.5/bin/xlf_at
```

Note: If you use the XL compiler with the Advance Toolchain support to build your application, your application can run only under the Advance Toolchain environment because the application depends on the runtime library of the Advance Toolchain. If you copy the application to run on other machines, ensure that the Advance Toolchain, or at least the runtime library of the Advance Toolchain, is available on those machines.

Editing the default configuration file

The configuration file specifies information that the compiler uses when you invoke it. XL Fortran provides the default configuration file `/opt/ibm/xlf/15.1.5/etc/xlf.cfg` at installation time.

If you want many users to be able to choose among several sets of compiler options, you may want to add new named stanzas to the configuration file and to create new commands that are links to existing commands. For example, you could specify something similar to the following to create a link to the `xlf95` command:

```
ln -s /opt/ibm/xlf/15.1.5/bin/xlf95 /home/username/bin/xlf95
```

When you run the compiler under another name, it uses whatever options, libraries, and so on, that are listed in the corresponding stanza.

Notes:

- The configuration file contains other named stanzas to which you may want to link.
- If you make any changes to the configuration file and then move or copy your makefiles to another system, you will also need to copy the changed configuration file.
- You cannot use tabs as separator characters in the configuration file. If you modify the configuration file, make sure that you use spaces for any indentation.

Configuration file attributes

The configuration file contains the following attributes:

as_64 The absolute path name of the assembler.

asopt Lists names of options that are assumed to be assembler options for cases where, for example, a compiler option and an assembler option use the same letter. The list is a concatenated set of single-letter flags. Any flag that takes an argument is followed by a colon, and the whole list is enclosed by double quotation marks. You may find it more convenient to set up this attribute than to pass options to the assembler through the `-W` compiler option.

bolt The absolute path name of the binder.

code The absolute path name of the optimizing code generator.

cpp The absolute path name of the C preprocessor, which is automatically called for files ending with a specific suffix (usually `.F`).

cppoptions

A string of options that are separated by commas, to be processed by `cpp`

(the C preprocessor) as if you entered them on the command line before any other option. This attribute is needed because some `cpp` options are usually required to produce output that can be compiled by XL Fortran. The default is `-C`, which preserves any C-style comments in the output. Also, refer to the “`-qfpp`” on page 137 and “`-qppsuborigarg`” on page 213 options for other useful `cpp` options.

Note: You can specify `-C!` preprocessor option on the command line (`-WF, -C!`) to override the default setting.

`cppsuffix`

The suffix that indicates a file must be preprocessed by the C preprocessor (`cpp`) before being compiled by XL Fortran. The default is `F`.

`crt_64` The path name of the object file which contains the startup code. This object file is passed as the first parameter to the linkage editor.

`CUDA Fortran` `cuda_libdirs_64`

The search path for the CUDA Toolkit libraries, specified via comma-separated `-L` options. This attribute is used only when the compiler is invoked with CUDA Fortran support. `CUDA Fortran`

`CUDA Fortran` `cuda_libraries_64`

The `-l` options, separated by commas, that specify the libraries used to link CUDA Fortran programs. `CUDA Fortran`

`CUDA Fortran` `cuda_path`

The absolute path name of the base of the CUDA Toolkit directory.

`CUDA Fortran`

`defaultmsg`

The absolute path name of the default message files.

`fsuffix` The allowed suffix for Fortran source files. The default is `f`. The compiler requires that all source files in a single compilation have the same suffix. Therefore, to compile files with other suffixes, such as `f95`, you must change this attribute in the configuration file or use the `-qsuffix` compiler option. For more information on `-qsuffix`, see “`-qsuffix`” on page 248.

`mcrt_64`

Same as for `crt_64`, but the object file contains profiling code for the `-p` option.

`gcrt_64`

Same as `crt_64`, but the object file contains profiling code for the `-pg` option.

`gcc_libs_64`

The linker options to specify the path to the GCC libraries and to link the GCC library.

`gcc_path_64`

Specifies the path to the 64-bit tool chain.

`hot` Absolute path name of the program that does array language transformations.

`include_64`

Indicates the search path that is used for compilation include files, module symbol files, and submodule symbol files.

`ipa` Absolute path name of the program that performs interprocedural optimizations, loop optimizations, and program parallelization.

ld_64 The absolute path name of the linker.

ldopt Lists names of options that are assumed to be linker options for cases where, for example, a compiler option and a linker option use the same letter. The list is a concatenated set of single-letter flags. Any flag that takes an argument is followed by a colon, and the whole list is enclosed by double quotation marks.

You might find it more convenient to set up this attribute than to pass options to the linker through the **-W** compiler option. However, most unrecognized options are passed to the linker anyway.

CUDA Fortran **llvm2ptx**

The absolute path name of the LLVM-IR to PTX translator. **CUDA Fortran**

CUDA Fortran **nvcc**

The absolute path name of the nvcc compiler. **CUDA Fortran**

options

A string of options that are separated by commas. The compiler processes these options as if you entered them on the command line before any other option. This attribute lets you shorten the command line by including commonly used options in one central place.

osuffix

The suffix used to recognize object files that are specified as input files. The default is **o**.

CUDA Fortran **partitioner**

The absolute path name of the W-Code IR partitioner. **CUDA Fortran**

CUDA Fortran **ptxas**

The absolute path name of the PTX assembler. **CUDA Fortran**

slm_dir

The directory of the SLM tag file. The default is **/var/opt/ibm/xl-compiler/** for a default installation, or ***\$prefix*/var/opt/ibm/xl-compiler/** for a nondefault installation, where *\$prefix* is the nondefault installation path.

slm_period

The number of seconds that each metric covers. The SLM daemon outputs the usage information for every defined period of time. The default is **300**.

slm_limit

The maximum number of bytes that each tag file is allowed to occupy. The default is **5000000**.

slm_timeout

The minimum number of seconds that the daemon must wait before terminating. The default is **5**.

slm_auth

The directory of the authorization file. The default is **/etc/XLAuthorizedUsers**.

smplibraries

Specifies the libraries that are used to link programs that you compiled with the **-qsmp** compiler option.

ssuffix

The suffix used to recognize assembler files that are specified as input files. The default is **s**.

use The named and local stanzas provide the values for attributes. For

single-valued attributes, values in the **use** attribute apply if there is no value in the local, or default, stanza. For comma-separated lists, the values from the **use** attribute are added to the values from the local stanza. You can only use a single level of the **use** attribute. Do not specify a **use** attribute that names a stanza with another **use** attribute.

CUDA Fortran **wc2llvm**

The absolute path name of the W-Code IR to LLVM-IR Translator.

CUDA Fortran

- xlfc** The absolute path name of the main compiler executable file. The compiler commands are driver programs that execute this file.
- xlfopt** Lists names of options that are assumed to be compiler options, for cases where, for example, a compiler option and a linker option use the same letter. The list is a concatenated set of single-letter flags. Any flag that takes an argument is followed by a colon, and the whole list is enclosed by double quotation marks.

Notes:

- To specify multiple search paths for compilation include files, separate each path location with a comma as follows:
include = -I/path1, -I/path2, ...
- You can use the “-F” on page 75 option to select a different configuration file, a specific stanza in the configuration file, or both.

Related information

- “XL Fortran input files” on page 26
- “XL Fortran output files” on page 27
- Chapter 9, “Tracking compiler license usage,” on page 295

Determining which level of XL Fortran is installed

Sometimes, you may not be sure which level of XL Fortran is installed on a particular machine. You would need to know this information before contacting software support.

To check whether the latest level of the product has been installed through the system installation procedure, issue the command:

On SLES, RHEL, and CentOS

```
rpm -qa | grep xlf.15.1.5 | xargs rpm -qi
```

On Ubuntu

```
dpkg -l xlf.15.1.5
```

The result includes the version, release, modification, and fix level of the compiler image installed on the system.

You can also use the **-qversion** compiler option to display the version, release, and level of the compiler and its components.

Running two levels of XL Fortran

It is possible for two different levels of the XL Fortran compiler to coexist on one system. This allows you to invoke one level by default and to invoke the other one whenever you explicitly choose to.

To do this, consult the *XL Fortran Installation Guide* for details.

Chapter 4. Editing, compiling, linking, and running XL Fortran programs

Most Fortran program development consists of a repeating cycle of editing, compiling and linking (which is by default a single step), and running. For problems encountered during the development cycle, refer to the following sections for help.

Prerequisite information:

1. Before you can use the compiler, all the required Linux settings (for example, certain environment variables and storage limits) must be correct for your user ID; for details, see “Correct settings for environment variables” on page 7.
2. To learn more about writing and optimizing XL Fortran programs, refer to the *XL Fortran Language Reference* and *XL Fortran Optimization and Programming Guide*.

Editing XL Fortran source files

To create Fortran source programs, you can use any of the available text editors, such as **vi** or **emacs**. Source programs must have a suffix of **.f** or its variation unless the **fsuffix** attribute in the configuration file specifies a different suffix, or the **-qsuffix** compiler option is used. You can also use a suffix of **.F** or its variation if the program contains C preprocessor (**cpp**) directives that must be processed before compilation begins. Source files with the **.f77**, **.f90**, **.f95**, **.f03**, **.f08**, or **>CUDA Fortran .cuf <CUDA Fortran** suffix are also valid.

For the Fortran source program to be a valid program, it must conform to the language definition that is specified in the *XL Fortran Language Reference*.

Compiling XL Fortran programs

To compile a source program, use one of the `xl f`, `xl f_r`, `xl f90`, `xl f90_r`, `f90`, `xl f95`, `xl f95_r`, `f95`, `xl f2003`, `xl f2003_r`, `f2003`, `xl f2008`, `xl f2008_r`, `f2008`, and `xl cucf` `CUDA Fortran` commands, which have the form:

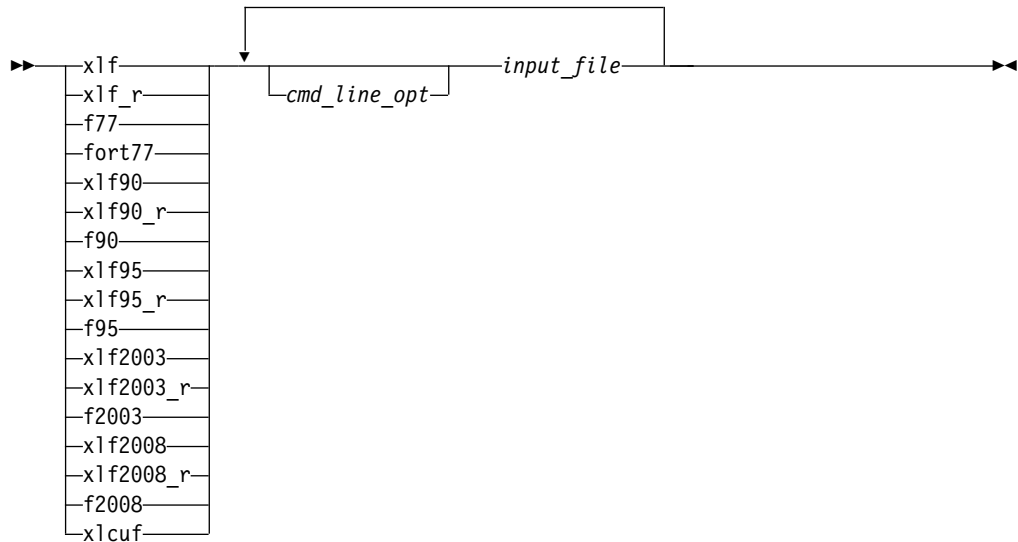

These commands all accept essentially the same Fortran language. The main difference is that they use different default options (which you can see by reading the configuration file `/opt/ibm/xl f/15.1.5/etc/xl f.cfg`).



The invocation command performs the necessary steps to compile the Fortran source files, assemble any `.s` files, and link the object files and libraries into an executable program. In particular, the `xl f_r`, `xl f90_r`, `xl f95_r`, `xl f2003_r`, `xl f2008_r`, and `xl cucf` `CUDA Fortran` commands use the components for multithreading (libraries, and so on) to link and bind object files.

The following table summarizes the invocation commands that you can use:

Table 6. XL Fortran Invocation commands

Driver Invocation ¹	Chief Functionality	Linked Libraries
<code>xl f</code>	Selected Fortran language level ³	<code>libxl f90.so</code>
<code>xl f_r</code>	The threadsafe version of the selected language level ³	<code>libxl f90_r.so</code>
<code>f77</code> , <code>fort77</code>	FORTTRAN 77	<code>libxl f90.so</code>
<code>xl f90</code> , <code>f90</code>	Fortran 90	<code>libxl f90.so</code>
<code>xl f90_r</code>	Threadsafe Fortran 90	<code>libxl f90_r.so</code>
<code>xl f95</code> , <code>f95</code>	Fortran 95	<code>libxl f90.so</code>
<code>xl f95_r</code>	Threadsafe Fortran 95	<code>libxl f90_r.so</code>
<code>xl f2003</code>	Fortran 2003	<code>libxl f90.so</code>
<code>xl f2003_r</code>	Threadsafe Fortran 2003	<code>libxl f90_r.so</code>
<code>f2003</code>	Fortran 2003	<code>libxl f90.so</code>

Table 6. XL Fortran Invocation commands (continued)

Driver Invocation ¹	Chief Functionality	Linked Libraries
<code>xlf2008</code>	Fortran 2008	<code>libxlf90.so</code>
<code>xlf2008_r</code>	Threadsafe Fortran 2008	<code>libxlf90_r.so</code>
<code>f2008</code>	Fortran 2008	<code>libxlf90.so</code>
 <code>xlcuf</code> ²	CUDA Fortran support	<code>libxlf90_r.so</code> , <code>libcudadevrt.a</code> , <code>libcudart.so</code> , <code>libcuda.so</code> , and <code>libdevice*.bc</code> 

Notes:

1. These invocation commands are contained in the `/opt/ibm/xlf/15.1.5/bin` directory.
2.  Specifying `xlcuf` is equivalent to specifying `xlf2008_r` and the `-qcuda` option.
3. The `xlf` and `xlf_r` invocation commands select the appropriate language level according to the suffix of the source file names. The other invocation commands behave consistently no matter what the Fortran source file name suffix is. See the following examples:

Example 1

```
xlf program1.f program2.f90 program3.f95 program4.f03 program5.f08
```

The behavior is as follows:

- The `program1.f` file is compiled as if the invocation command was `f77`.
- The `program2.f90` file is compiled as if the invocation command was `xlf90`.
- The `program3.f95` file is compiled as if the invocation command was `xlf95`.
- The `program4.f03` file is compiled as if the invocation command was `xlf2003`.
- The `program5.f08` file is compiled as if the invocation command was `xlf2008`.

 **Example 2**

```
xlf_r program6.cuf
```

The `program6.cuf` file is compiled as if the invocation command was `xlcuf`, which enables CUDA Fortran support.



`libxlf90.so` is provided for both threaded and non-threaded applications. XL Fortran determines at run time whether your application is threaded.

XL Fortran provides the library `libxlf90_t.so`, in addition to `libxlf90_r.so`. `libxlf90_t.so` exports the same entry points as `libxlf90_r.so` does. The library `libxlf90_r.so` is a superset of `libxlf90_t.so`. The file `xlf.cfg` is set up to link to `libxlf90_r.so` automatically when you use the `xlf90_r`, `xlf95_r`, and `xlf_r` commands. `libxlf90_t.so` is a partial thread-support runtime library. Unlike `libxlf90_r.so`, `libxlf90_t.so` does not provide thread synchronization and routines in `libxlf90_t.so` are not thread-reentrant. Therefore, only one Fortran thread at a time can perform I/O operations or invoke Fortran intrinsics. You can use `libxlf90_t.so` instead of `libxlf90_r.so` in multithread applications where there is only one Fortran thread, to avoid the thread synchronization overhead in `libxlf90_r.so`.

When you bind a multithreaded executable with multiple Fortran threads, `libxlf90_r.so` should be used. Note that using the `xlf_r`, `xlf90_r`, `xlf95_r`, `xlf2003_r`, `xlf2008_r`, or `CUDA Fortran xlcuf CUDA Fortran` invocation command ensures the proper linking.

The directive triggers that are implied by invocation commands or options are listed as follows:

- For `f77`, `fort77`, `f90`, `f95`, `f2003`, `xlf`, `xlf90`, `xlf95`, `xlf2003`, and `xlf2008` invocation commands, the directive trigger is `IBM*` by default.
- For all other invocation commands, the directive triggers are `IBM*` and `IBMT` by default.
- When `-qsmp` is in effect, the compiler also recognizes the `IBMP`, `SMP$`, and `$OMP` directive triggers.
- When `-qthreaded` is in effect, the compiler also recognizes the `IBMT` directive trigger.

Compiling XL Fortran Version 2 programs

When used to compile `.f`, `.F`, `.f77`, or `.F77` files, `xlf` maintains, wherever possible, compatibility with existing programs by using the same I/O formats as earlier versions of XL Fortran and some implementation behavior compatible with FORTRAN 77.

If the configuration file has not been customized, `f77` is identical to `xlf` when `xlf` is used to compile the `.f`, `.F`, `.f77`, or `.F77` files.

You may find that you need to continue using these commands for compatibility with existing makefiles and build environments. However, be aware that programs that you compile with these commands may not conform to the newer standard in subtle ways.

Compiling Fortran 90 or Fortran 95 programs

The `f90`, `xlf90`, and `xlf90_r` commands make your programs conform more closely to the Fortran 90 standard than do the other invocation commands. The `f95`, `xlf95`, and `xlf95_r` commands make your programs conform more closely to the Fortran 95 standard than do the other invocation commands. `f90`, `xlf90`, `xlf90_r`, `f95`, `xlf95`, and `xlf95_r` are the preferred commands for compiling any new programs. They all accept Fortran 90 free source form by default; to use them for fixed source form, you must use the `-qfixed` option. I/O formats are slightly different between these commands and the other commands. I/O formats also differ between the set of `f90`, `xlf90` and `xlf90_r` commands and the set of `f95`, `xlf95` and `xlf95_r` commands. We recommend that you switch to the Fortran 95 formats for data files whenever possible.

By default, the `f90`, `xlf90`, and `xlf90_r` commands do not conform completely to the Fortran 90 standard. Also, by default, the `f95`, `xlf95`, and `xlf95_r` commands do not conform completely to the Fortran 95 standard. If you need full Fortran 90 or Fortran 95 compliance, compile with any of the following additional compiler options (and suboptions):

```
-qnodirective -qnoescape -qfloat=nomaf:nofold -qnoswapomp  
-qlanglvl=90std  
-qlanglvl=95std
```

Also, specify the following runtime options before running the program, with a command similar to one of the following:

```
export XLFRTFOPTS="err_recovery=no:langlvl=90std"
export XLFRTFOPTS="err_recovery=no:langlvl=95std"
```

The default settings are intended to provide the best combination of performance and usability. Therefore, it is usually a good idea to change them only when required. Some of the options above are only required for compliance in very specific situations.

Compiling Fortran 2003 programs

The **f2003**, **xf2003**, and **xf2003_r** commands make your programs conform more closely to the Fortran 2003 Standard than do the other invocation commands. The Fortran 2003 commands accept free source form by default. I/O formats for the Fortran 2003 commands are the same as for the **f95**, **xf95**, and **xf95_r** commands. The Fortran 2003 commands format infinity and NaN floating-point values differently from previous commands. The Fortran 2003 commands enable polymorphism by default.

By default, the **f2003**, **xf2003**, and **xf2003_r** commands do not conform completely to the Fortran 2003 standard. If you need full compliance, compile with the following additional compiler suboptions:

```
-qlanglvl=2003std -qnodirective -qnoescape -qfloat=nomaf:rndsngl:nofold
-qnoswapomp -qstrictieemod
```

Also specify the following runtime options:

```
XLFRTFOPTS="err_recovery=no:langlvl=2003std:iostat_end=2003std:
internal_nldelim=2003std"
```

Compiling Fortran 2008 programs

The **f2008**, **xf2008**, and **xf2008_r** commands make your programs conform more closely to the Fortran 2008 Standard than the other invocation commands do. The Fortran 2008 commands accept free source form by default. I/O formats for the Fortran 2008 commands are the same as for the **f95**, **xf95**, **xf95_r**, **xf95_r7**, **f2003**, **xf2003**, and **xf2003_r** commands. The Fortran 2008 commands format infinity and NaN floating-point values in the same way as the Fortran 2003 commands. The Fortran 2008 commands enable polymorphism by default.

By default, the **f2008**, **xf2008**, and **xf2008_r** commands do not conform completely to the Fortran 2008 standard. If you need full compliance, compile with the following additional compiler suboptions:

```
-qlanglvl=2008std -qnodirective -qnoescape -qfloat=nomaf:rndsngl:nofold
-qnoswapomp -qstrictieemod
```

Also specify the following runtime options:

```
XLFRTFOPTS="err_recovery=no:langlvl=2008std:iostat_end=2003std:
internal_nldelim=2003std"
```

Related information

- “Compiling Fortran 2003 programs”

Compiling CUDA Fortran programs

You can use one of the following methods to enable CUDA Fortran support:

- Use the **xlcuF** invocation command to compile any Fortran source files. Specifying **xlcuF** is equivalent to specifying **xf2008_r** and the **-qcuda** option.

- Use the `xlf_r` invocation command to compile source files with the `.cuf` or `.CUF` suffixes. The `xlf_r` invocation command recognizes `.cuf` and `.CUF` files as CUDA Fortran files and enables CUDA Fortran support automatically.
- Use any threadsafe invocation command, such as `xlf95_r`, and specify the `-qcuda` option to compile any Fortran source files.

Compiling and linking a library

Compiling a static library

To compile a static library:

1. Compile each source file into an object file, with no linking. For example:

```
xlf -c bar.f example.f
```
2. Use the `ar` command to add the generated object files to an archive library file. For example:

```
ar -rv libfoo.a bar.o example.o
```

Compiling a shared library

To compile a shared library, you must use the `-qpik` option.

Use the following steps to compile a shared library:

1. Compile your source files into an object file, with no linking. For example:

```
xlf -qpik -c foo.f
```
2. Use the `-qmkshrobj` compiler option to create a shared object from the generated object files. For example:

```
xlf -qmkshrobj -o libfoo.so foo.o
```

Related information in the *XL Fortran Compiler Reference*

 `-qpik`

 `-qmkshrobj`

Linking a library to an application

You can use the same command string to link a static or shared library to your main program. For example:

```
xlf -o myprogram main.f -Ldirectory1:directory2 [-Rdirectory] -ltest
```

At compile time, you instruct the linker to search for `libtest.so` in the first directory specified via the `-L` option. If `libtest.so` is not found, the linker searches for `libtest.a`. If neither file is found, the search continues with the next directory specified via the `-L` option.

At run time, the runtime linker searches for `libtest.so` in the first directory specified via the `-R` option. If `libtest.so` is not found, the search continues with the next directory specified via the `-R` option. The path specified by the `-R` option can be overridden at run time via the `LD_LIBRARY_PATH` environment variable.

For additional linkage options, including options that modify the default behavior, see the operating system `ld` documentation .

Related information in the *XL Fortran Compiler Reference*

 `-l`

 `-L`

Linking a shared library to another shared library

Just as you link modules into an application, you can create dependencies between shared libraries by linking them together. For example:





```
xlf -qmshrobj -o mylib.so myfile.o -Ldirectory -Rdirectory -lfoo
```

Related information in the XL Fortran Compiler Reference

 -qmshrobj

 -L



Compiling XL Fortran SMP programs

You can use the `xlf_r`, `xlf90_r`, `xlf95_r`, `xlf2003_r`, `xlf2008_r`, or  `xlcutf`  command to compile XL Fortran SMP programs. The `xlf_r` command is similar to the `xlf` command; the `xlf90_r` command is similar to the `xlf90` command; the `xlf95_r` command is similar to the `xlf95` command; the `xlf2003_r` command is similar to the `xlf2003` command; the `xlf2008_r` command is similar to the `xlf2008` command.  Specifying `xlcutf` is equivalent to specifying `xlf2008_r` and the `-qcuda` option.  The main difference is that the components for multi-threading are used to link and bind the object files if you specify the `xlf_r`, `xlf90_r`, `xlf95_r`, `xlf2003_r`, or `xlf2008_r` command.

Note that using any of these commands alone does not imply parallelization. For the compiler to recognize the SMP directives and activate parallelization, you must also specify `-qsmp`. In turn, you can only specify the `-qsmp` option in conjunction with one of these invocation commands. When you specify `-qsmp`, the driver links in the libraries specified on the `smplibraries` line in the active stanza of the configuration file.

POSIX pthreads API support



XL Fortran supports thread programming with the IEEE 1003.1-2001 (POSIX) standard pthreads API.

To compile and then link your program with the standard interface libraries, use the `xlf_r`, `xlf90_r`, `xlf95_r`, `xlf2003_r`, `xlf2008_r`, or  `xlcutf`  command. For example, you could specify:

```
xlf95_r test.f
```

Compilation order for Fortran programs

If you have a program unit, subprogram, or interface body that uses a module, you must first compile the module. If the module and the code that uses the module are in separate files, you must first compile the file that contains the module. If they are in the same file, the module must come before the code that uses it in the file. If you change any entity in a module, you must recompile any files that use that module.

 If only the implementation of a separate module procedure is changed, but the interface remains the same, you do not need to recompile the file that contains the module in which the corresponding module procedure interface body is declared. 

Canceling a compilation

To stop the compiler before it finishes compiling, press **Ctrl+C** in interactive mode, or use the `kill` command.

XL Fortran input files

The input files to the compiler are:

Source Files (.f or .F suffix or its variation)

All `.f`, `.f77`, `.f90`, `.f95`, `.f03`, `.f08`, `.cuf`, `.F`, `.F77`, `.F90`, `.F95`, `.F03`, `.F08`, and `.CUF` files are source files for compilation. The compiler compiles source files in the order you specify on the command line. If it cannot find a specified source file, the compiler produces an error message and proceeds to the next file, if one exists. Files with a suffix that contains the uppercase letter F are passed through the C preprocessor (`cpp`) before being compiled.

Include files also contain source and often have different suffixes from `.f`.

Related information: See “Passing Fortran files through the C preprocessor” on page 32.

The `fsuffix` and `cppsuffix` attributes in “Editing the default configuration file” on page 14 and “-qsuffix” on page 248 let you select a different suffix.

Object Files (.o suffix)

All `.o` files are object files. After the compiler compiles the source files, it uses the `ld` command to link-edit the resulting `.o` files, any `.o` files that you specify as input files, and some of the `.o` and `.a` files in the product and system library directories. It then produces a single executable output file.

Related information: See “Linking” on page 65 and “Linking XL Fortran programs” on page 34.

The `osuffix` attribute, which is described in “Editing the default configuration file” on page 14 and “-qsuffix” on page 248, lets you select a different suffix.

Assembler Source Files (.s suffix)

The compiler sends any specified `.s` files to the assembler (`as`). The assembler output consists of object files that are sent to the linker at link time.

Related information: The `ssuffix` attribute, which is described in “Editing the default configuration file” on page 14 and “-qsuffix” on page 248, lets you select a different suffix.

Shared Object or Library Files (.so suffix)

These are object files that can be loaded and shared by multiple processes at run time. When a shared object is specified during linking, information about the object is recorded in the output file, but no code from the shared object is actually included in the output file.

Configuration Files (.cfg suffix)

The contents of the configuration file determine many aspects of the compilation process, most commonly the default options for the compiler. You can use it to centralize different sets of default compiler options or to keep multiple levels of the XL Fortran compiler present on a system.

The default configuration file is `/opt/ibm/xlf/15.1.5/etc/xlf.cfg`.

Related information: See “Using custom compiler configuration files” on page 10 and “-F” on page 75 for information about selecting the configuration file.

Module Symbol Files: *modulename.mod*

A module symbol file is an output file from compiling a module and is an input file for subsequent compilations of files that **USE** that module. One **.mod** file is produced for each module, so compiling a single source file may produce multiple **.mod** files.

Related information: See “-I” on page 80 and “-qmoddir” on page 193.

F2008 **Submodule Symbol Files:** *ancestormodulename_submodulename.smod*

A submodule symbol file is an output file from compiling a submodule and is an input file for subsequent compilations of the descendant submodules. One **.smod** file is produced for each submodule, so compiling a single source file might produce multiple **.smod** files.

The submodule symbol file is not needed for compiling the ancestor module or any compilation units that access the ancestor module via use association.

Related information: See “-qmoddir” on page 193.

F2008**Profile Data Files**

The **-qpdf1** option produces runtime profile information for use in subsequent compilations. This information is stored in one or more hidden files with names that match the pattern “**.pdf***” or “**.pdf_map***”.

Related information: See “-qpdf1, -qpdf2” on page 202.

XL Fortran output files

The output files that XL Fortran produces are:

Executable Files: *a.out*

By default, XL Fortran produces an executable file that is named **a.out** in the current directory.

Related information: See “-o” on page 89 for information on selecting a different name and “-c” on page 73 for information on generating only an object file.

Object Files: *filename.o*

If you specify the **-c** compiler option, instead of producing an executable file, the compiler produces an object file for each specified source file, and the assembler produces an object file for each specified assembler source file. By default, the object files have the same file name prefixes as the source files and appear in the current directory.

Related information:

- For the **-c** compiler option, see “-c” on page 73 and “Linking XL Fortran programs” on page 34.
- For information on renaming the object file, see “-o” on page 89.

Assembler Source Files: *filename.s*

If you specify the **-S** compiler option, instead of producing an executable file, the XL Fortran compiler produces an equivalent assembler source file for each specified source file. By default, the assembler source files have the same file name prefixes as the source files and appear in the current directory.

Related information: See “-S” on page 278 and “Linking XL Fortran programs” on page 34. For information on renaming the assembler source file, see “-o” on page 89.

Compiler Listing Files: *filename.lst*

By default, no listing is produced unless you specify one or more listing-related compiler options. The listing file is placed in the current directory, with the same file name prefix as the source file and a suffix of **.lst**.

Related information: See “Listings, messages, and compiler information” on page 60.

Module Symbol Files: *modulename.mod*

Each module has an associated symbol file that holds information needed by program units, subprograms, and interface bodies that **USE** that module. By default, these symbol files must exist in the current directory.

Related information: For information on putting **.mod** files in a different directory, see “-qmoddir” on page 193.

F2008 **Submodule Symbol Files:** *ancestormodulename_submodulename.smod*

Each submodule has an associated symbol file that holds information needed by the descendant submodules. By default, these symbol files must exist in the current directory.

The submodule symbol file is not needed for compiling the ancestor module or any compilation units that access the ancestor module via use association.

Related information: For information on putting **.smod** files in a different directory, see “-qmoddir” on page 193.

F2008 <

cpp-Preprocessed Source Files: *Ffilename.f*

If you specify the **-d** option when compiling a file with a **.F** suffix, the intermediate file created by the C preprocessor (cpp) is saved rather than deleted.

Related information: See “Passing Fortran files through the C preprocessor” on page 32 and “-d” on page 74.

Profile Data Files (.pdf*, .pdf_map*)

These are the files that the **-qpdf1** option produces. They are used in subsequent compilations to tune optimizations that are based on actual execution results.

Related information: See “-qpdf1, -qpdf2” on page 202.

Dependency Files: *filename.d*

A dependency file contains source file dependency information. Dependency files are used by the **make** command to determine the order in which files should be compiled and the minimum set of files that must be recompiled when a file is changed. You can specify the “-MMD” on page 84 or “-qmakedep” on page 185 option to generate a dependency file.

Related information: For information on setting the name of the dependency file, see “-MF” on page 83. For information on specifying the target name of the object file in the dependency file, see “-MT” on page 85.

Scope and precedence of option settings

You can specify compiler options in any of three locations. Their scope and precedence are defined by the location you use. (XL Fortran also has comment directives, such as **SOURCEFORM**, that can specify option settings. There is no general rule about the scope and precedence of such directives.)

Location	Scope	Precedence
In a stanza of the configuration file.	All compilation units in all files compiled with that stanza in effect.	Lowest
On the command line.	All compilation units in all files compiled with that command.	Medium
In an @PROCESS directive. (XL Fortran also has comment directives, such as SOURCEFORM , that can specify option settings. There is no general rule about the scope and precedence of such directives.)	The following compilation unit.	Highest

If you specify an option more than once with different settings, the last setting generally takes effect. Any exceptions are noted in the individual descriptions in the Chapter 6, “Detailed descriptions of the XL Fortran compiler options,” on page 69 and are indexed under “conflicting options”.

Specifying options on the command line

XL Fortran supports the traditional UNIX method of specifying command-line options, with one or more letters (known as flags) following a minus sign:

```
xlf95 -c file.f
```

You can often concatenate multiple flags or specify them individually:

```
xlf95 -cv file.f    # These forms
xlf95 -c -v file.f # are equivalent
```

(There are some exceptions, such as **-pg**, which is a single option and not the same as **-p -g**.)

Some of the flags require additional argument strings. Again, XL Fortran is flexible in interpreting them; you can concatenate multiple flags as long as the flag with an argument appears at the end. The following example shows how you can specify flags:

```
# All of these commands are equivalent.
xlf95 -g -v -o montecarlo -p montecarlo.f
xlf95 montecarlo.f -g -v -o montecarlo -p
xlf95 -g -v montecarlo.f -o montecarlo -p
xlf95 -g -v -omontecarlo -p montecarlo.f
# Because -o takes a blank-delimited argument,
# the -p cannot be concatenated.
xlf95 -gvomontecarlo -p montecarlo.f
# Unless we switch the order.
xlf95 -gvpomontecarlo montecarlo.f
```

If you are familiar with other compilers, particularly those in the XL family of compilers, you may already be familiar with many of these flags.

You can also specify many command-line options in a form that is intended to be easy to remember and make compilation scripts and makefiles relatively self-explanatory:

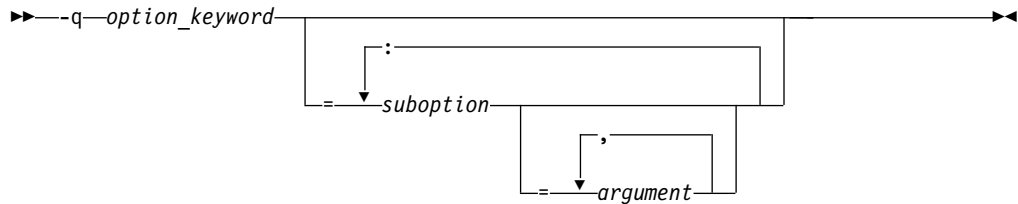

This format is more restrictive about the placement of blanks; you must separate individual **-q** options by blanks, and there must be no blank between a **-q** option and a following argument string. Unlike the names of flag options, **-q** option names are not case-sensitive except that the **q** must be lowercase. Use an equal sign to separate a **-q** option from any arguments it requires, and use colons to separate suboptions within the argument string.

For example:

```
xlf95 -qddim -qXREF=full -qfloat=nomaf:rsqrt -03 -qcache=type=c:level=1 file.f
```

Specifying options in the source file

By putting the **@PROCESS** compiler directive in the source file, you can specify compiler options to affect an individual compilation unit. The **@PROCESS** compiler directive can override options specified in the configuration file, in the default settings, or on the command line.

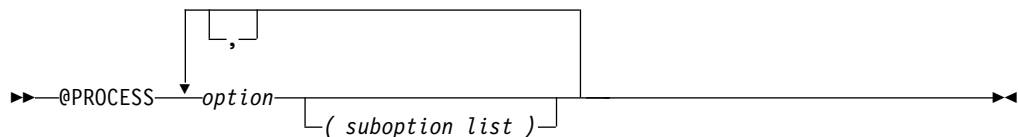

option is the name of a compiler option without the **-q**.

suboption

is a suboption of a compiler option.

In fixed source form, **@PROCESS** can start in column 1 or after column 6. In free source form, the **@PROCESS** compiler directive can start in any column.

You cannot place a statement label or inline comment on the same line as an **@PROCESS** compiler directive.

By default, option settings you designate with the **@PROCESS** compiler directive are effective only for the compilation unit in which the statement appears. If the file has more than one compilation unit, the option setting is reset to its original state before the next unit is compiled. Trigger constants specified by the **DIRECTIVE** option are in effect until the end of the file (or until **NODIRECTIVE** is processed).

The `@PROCESS` compiler directive must usually appear before the first statement of a compilation unit. The only exceptions are when specifying `SOURCE` and `NOSOURCE`; you can put them in `@PROCESS` directives anywhere in the compilation unit.

Passing command-line options to the "ld" or "as" command

Because the compiler automatically executes other commands, such as `ld` and `as`, as needed during compilation, you usually do not need to concern yourself with the options of those commands. If you want to choose options for these individual commands, you can do one of the following:

- Include linker options on the compiler command line. When the compiler does not recognize a command-line option other than a `-q` option, it passes the option on to the linker. For example:

```
xlf95 --print-map file.f # --print-map is passed to ld
```

- Use the `-W` or `-X` compiler option to construct an argument list for the command. For example:

```
xlf95 -Wl,--print-map file.f # --print-map is passed to ld
```

In this example, the `ld` option `--print-map` is passed to the linker (which is denoted by the `l` in the `-Wl` option) when the linker is executed.

This form is more general than the previous one because it works for the `as` command and any other commands called during compilation, by using different letters after the `-W` option.

- Edit the configuration file `/opt/ibm/xlf/15.1.5/etc/xlf.cfg`, or construct your own configuration file. You can customize particular stanzas to allow specific command-line options to be passed through to the assembler or linker.

For example, if you include these lines in the `xlf95` stanza of `/opt/ibm/xlf/15.1.5/etc/xlf.cfg`:

```
asopt = "W"  
ldopt = "M"
```

and issue this command:

```
xlf95 -Wa,-Z -Wl,-s -w produces_warnings.s uses_many_symbols.f
```

the file `produces_warnings.s` is assembled with the options `-W` and `-Z` (issue warnings and produce an object file even if there are compilation errors), and the linker is invoked with the options `-s` and `-M` (strip final executable file and produce a load map).

Related information: See “`-W`, `-X`” on page 283 and “Using custom compiler configuration files” on page 10.

Displaying information inside binary files (strings)

The `strings` command reads information encoded into some binary files, as follows:

- Information about the compiler version is encoded in the compiler binary executables and libraries.
- Information about the parent module, bit mode, the compiler that created the `.mod` file, the date and time the `.mod` file was created, and the source file is encoded in each `.mod` file.

For example, to see the information embedded in `/opt/ibm/xlf/15.1.5/exe/xlfentry`, issue the following command:

```
strings /opt/ibm/xlf/15.1.5/exe/xlfentry | grep "@(#)"
```

Compiling for specific architectures

You can use `-qarch` and `-qtune` to instruct the compiler to generate and tune code for a particular architecture. This allows the compiler to take advantage of machine-specific instructions that can improve performance. The `-qarch` option determines the architectures on which the resulting programs can run. The `-qtune` and `-qcache` options refine the degree of platform-specific optimization performed.

By default, the `-qarch` setting produces code using only instructions common to all supported architectures, with resultant settings of `-qtune` and `-qcache` that are relatively general. To tune performance for a particular processor set or architecture, you may need to specify different settings for one or more of these options. The natural progression to try is to use `-qarch`, and then add `-qtune`, and then add `-qcache`. Because the defaults for `-qarch` also affect the defaults for `-qtune` and `-qcache`, the `-qarch` option is often all that is needed.

If the compiling machine is also the target architecture, `-qarch=auto` will automatically detect the setting for the compiling machine. For more information on this compiler option setting, see “`-qarch`” on page 97 and also `-O4` and `-O5` under the `-O` option.

If the compiling machine is also the target architecture, `-qtune=auto` will automatically detect the setting for the compiling machine. For more information on this compiler option setting, see “`-qtune`” on page 255 and also `-O4` and `-O5` under the `-O` option.

If your programs are intended for execution mostly on particular architectures, you may want to add one or more of these options to the configuration file so that they become the default for all compilations.

Passing Fortran files through the C preprocessor

A common programming practice is to pass files through the C preprocessor (`cpp`). `cpp` can include or omit lines from the output file based on user-specified conditions (“conditional compilation”). It can also perform string substitution (“macro expansion”).

XL Fortran can use `cpp` to preprocess a file before compiling it.

To call `cpp` for a particular file, use a file suffix of `.F`, `.F77`, `.F90`, `.F95`, `.F03`, `.F08`, or `>CUDA Fortran .CUF <CUDA Fortran .`. Such file is preprocessed into an intermediate file. You can save the intermediate file by specifying the `-d` compiler option; otherwise, the file is deleted. If you specify the `-d` option, the intermediate file name is `Ffilename.f*` or `>CUDA Fortran Ffilename.cuf <CUDA Fortran .`. Otherwise, the intermediate file name is `/tmpdir/F8xxxxxx`, where `x` is an alphanumeric character and `tmpdir` is the contents of the `TMPDIR` environment variable or, if you have not specified a value for `TMPDIR`, `/tmp`. If you only want to preprocess and do not want to produce object or executable files, specify the `-qnoobject` option also.

When XL Fortran uses `cpp` for a file, the preprocessor will emit `#line` directives unless you also specify the `-d` option. The `#line` directive associates code that is created by `cpp` or any other Fortran source code generator with input code that you create. The preprocessor may cause lines of code to be inserted or deleted. Therefore, the `#line` directives that it emits can be useful in error reporting and debugging, because they identify the source statements found in the preprocessed code by listing the line numbers that were used in the original source.

The `_OPENMP` C preprocessor macro can be used to conditionally include code. This macro is defined when the C preprocessor is invoked and when you specify the `-qsmp=omp` compiler option. An example of using this macro follows:

```

    program par_mat_mul
    implicit none
    integer(kind=8)                :: i,j,nthreads
    integer(kind=8),parameter      :: N=60
    integer(kind=8),dimension(N,N) :: Ai,Bi,Ci
    integer(kind=8)                :: Sumi
#ifdef _OPENMP
    integer omp_get_num_threads
#endif

    common/data/ Ai,Bi,Ci
!$OMP threadprivate (/data/)

!$omp parallel
    forall(i=1:N,j=1:N) Ai(i,j) = (i-N/2)**2+(j+N/2)
    forall(i=1:N,j=1:N) Bi(i,j) = 3-((i/2)+(j-N/2)**2)
!$omp master
#ifdef _OPENMP
    nthreads=omp_get_num_threads()
#else
    nthreads=8
#endif
!$omp end master
!$omp end parallel

!$OMP parallel default(private),copyin(Ai,Bi),shared(nthreads)
!$omp do
    do i=1,nthreads
        call imat_mul(Sumi)
    enddo
!$omp end do
!$omp end parallel

end

```

See *Conditional compilation* in the *Language Elements* section of the *XL Fortran Language Reference* for more information on conditional compilation.

To customize `cpp` preprocessing, the configuration file accepts the attributes `cpp`, `cppsuffix`, and `cppoptions`.

The letter `F` denotes the C preprocessor with the `-t` and `-W` options.

Related information:

- “-d” on page 74
- “-t” on page 279
- “-W, -X” on page 283
- “-qfpp” on page 137
- “-qppsuborigarg” on page 213
- “Using custom compiler configuration files” on page 10

cpp directives for XL Fortran programs

Macro expansion can have unexpected consequences that are difficult to debug, such as modifying a `FORMAT` statement or making a line longer than 72 characters in fixed source form. Therefore, we recommend using `cpp` primarily for conditional compilation of Fortran programs. The `cpp` directives that are most often used for conditional compilation are `#if`, `#ifdef`, `#ifndef`, `#elif`, `#else`, and `#endif`.

Passing options to the C preprocessor

Because the compiler does not recognize `cpp` options other than `-I` directly on the command line, you must pass them through the `-W` or `-X` option. For example, if a program contains `#ifdef` directives that test the existence of a symbol named `LNXXV1`, you can define that symbol to `cpp` by compiling with either of the following commands:

```
xlf95 conditional.F -WF,-DLNXXV1
xlf95 conditional.F -Xpreprocessor -DLNXXV1
```

Avoiding preprocessing problems

Because Fortran and C differ in their treatment of some sequences of characters, be careful when using `/*` or `*/`. These might be interpreted as C comment delimiters, possibly causing problems even if they occur inside Fortran comments. Also be careful when using three-character sequences that begin with `??` (which might be interpreted as C trigraphs).

Consider the following example:

```
program testcase
character a
character*4 word
a = '?'
word(1:2) = '??'
print *, word(1:2)
end program testcase
```

If the preprocessor matches your character combination with the corresponding trigraph sequence, your output may not be what you expected.

If your code does *not* require the use of the XL Fortran compiler option `-qnoescape`, a possible solution is to replace the character string with an escape sequence `word(1:2) = '\?\?'`. However, if you are using the `-qnoescape` compiler option, this solution will not work. In this case, you require a `cpp` that will ignore the trigraph sequence. XL Fortran uses the `cpp` that is shipped as part of the compiler. It is ISO C compliant and therefore recognizes trigraph sequences.

Linking XL Fortran programs

By default, you do not need to do anything special to link an XL Fortran program. The compiler invocation commands automatically call the linker to produce an executable output file. For example, running the following command compiles and produces object files `file1.o` and `file3.o`.

```
xlf95 file1.f file2.o file3.f
```

Then all object files are submitted to the linker to produce one executable file.

After linking, follow the instructions in “Running XL Fortran programs” on page 36 to execute the program.

To link a library, follow the instructions in “Compiling and linking a library” on page 24.

Note: If you want to use a nondefault linker, you can use either of the following options:

- Use `-qpath` to specify the nondefault linker, for example,
`-qpath=1:linker_path`

- Customize the configuration file of the compiler to use the nondefault linker. For more information about how to customize the configuration file, see Using custom compiler configuration files and Creating custom configuration files.

Compiling and linking in separate steps

To produce object files that can be linked later, use the `-c` option.

```
xlf95 -c file1.f           # Produce one object file (file1.o)
xlf95 -c file2.f file3.f   # Or multiple object files (file1.o, file3.o)
xlf95 file1.o file2.o file3.o # Link object files with appropriate libraries
```

It is often best to execute the linker through the compiler invocation command, because it passes some extra `ld` options and library names to the linker automatically.

Passing options to the ld command

For the detailed information about passing options to the `ld` command, see Passing command-line options to the "ld" or "as" command.

Dynamic and static linking

XL Fortran allows your programs to take advantage of the operating system facilities for both dynamic and static linking:

- Dynamic linking means that the code for some external routines is located and loaded when the program is first run. When you compile a program that uses shared libraries, the shared libraries are dynamically linked to your program by default.

Dynamically linked programs take up less disk space and less virtual memory if more than one program uses the routines in the shared libraries. During linking, there are less chances for naming conflicts with library routines or external data objects because only exported symbols are visible outside a shared library. They may perform better than statically linked programs if several programs use the same shared routines at the same time. They also allow you to upgrade the routines in the shared libraries without relinking.

Because this form of linking is the default, you need no additional options to turn it on.

- Static linking means that the code for all routines called by your program becomes part of the executable file.

Statically linked programs can be moved to and run on systems without the XL Fortran libraries. They may perform better than dynamically linked programs if they make many calls to library routines or call many small routines. There are more chances for naming conflicts with library routines or external data objects because all global symbols are visible outside a static library. They also may not work if you compile them on one level of the operating system and run them on a different level of the operating system.

To link statically, add the `-qstaticlink` option to the linker command. For example:

```
xlf95 -qstaticlink test.f
```

Avoiding naming conflicts during linking

If you define an external subroutine, external function, or common block with the same name as a runtime or system library routine, your definition of that name may be used in its place, or it may cause a link-edit error.

Try the following general solution to help avoid these kinds of naming conflicts:

- Compile all files with the **-qextname** option. It adds an underscore to the end of the name of each global entity, making it distinct from any names in the system libraries.

Note: When you use this option, you do not need to use the final underscore in the names of Service and Utility Subprograms, such as **dtime_** and **flush_**.

- Link your programs dynamically, which is the default.

If you do not use the **-qextname** option, you must take the following extra precautions to avoid conflicts with the names of the external symbols in the XL Fortran and system libraries:

- Do not name a subroutine or function **main**, because XL Fortran defines an entry point **main** to start your program.
- Do not use *any* global names that begin with an underscore. In particular, the XL Fortran libraries reserve all names that begin with **_xl**.
- Do not use names that are the same as names in the XL Fortran library or one of the system libraries. To determine which names are not safe to use in your program, run the **nm** command on any libraries that are linked into the program and search the output for names you suspect might also be in your program.

Be careful not to use the names of subroutines or functions without defining the actual routines in your program. If the name conflicts with a name from one of the libraries, the program could use the wrong version of the routine and not produce any compile-time or link-time errors.

Running XL Fortran programs

The default file name for the executable program is **a.out**. You can select a different name with the **-o** compiler option. You should avoid giving your programs the same names as system or shell commands (such as **test** or **cp**), as you could accidentally execute the wrong command. If a name conflict does occur, you can execute the program by specifying a path name, such as **./test**.

You can run a program by entering the path name and file name of an executable file along with any runtime arguments on the command line.

Canceling execution

To suspend a running program, press the **Ctrl+Z** key while the program is in the foreground. Use the **fg** command to resume running.

To cancel a running program, press the **Ctrl+C** key while the program is in the foreground.

Compiling and executing on different systems

If you want to move an XL Fortran executable file to a different system (running the same or a compatible operating system) for execution, you can link statically and copy the program, and optionally the runtime message catalogs. Alternatively, you can link dynamically and copy the program as well as the XL Fortran libraries if needed and optionally the runtime message catalogs. For non-SMP programs, **libxlf90.so**, **libxlfmath.so**, and **libxlfomp_ser.so** are usually the only XL Fortran libraries needed. For SMP programs, you will usually need at least the **libxlf90.so**, **libxlfmath.so**, and **libxlfomp.so** libraries. **libxlfpmnt*.so** is only needed if the program is compiled with the **-qautodbl** option.

For a dynamically linked program to work correctly, the XL Fortran libraries and the operating system on the execution system must be at either the same level or a more recent level than on the compilation system.

For a statically linked program to work properly, the operating system level may need to be the same on the execution system as it is on the compilation system.

Related information: See “Dynamic and static linking” on page 35.

Runtime libraries for POSIX pthreads support

There are two runtime libraries that are connected with POSIX thread support. The `libxlf90_r.so` library is a threadsafe version of the Fortran runtime library. The `libxlsmp.so` library is the SMP runtime library.

Depending on the invocation command, and in some cases, the compiler option, the appropriate set of libraries for thread support is bound in. For example:

Command	Libraries Used	Include Directory
<code>xlf90_r</code> <code>xlf95_r</code>	<code>/opt/ibm/xlf/15.1.5/lib/libxlf90_r.so</code>	<code>/opt/ibm/xlf/15.1.5/include</code>
<code>xlf_r</code>	<code>/opt/ibm/xlf/15.1.5/lib/libxlsmp.so</code>	

Setting runtime options

Internal switches in an XL Fortran program control runtime behavior, similar to the way compiler options control compile-time behavior. You can set the runtime options through either environment variables or a procedure call within the program. You can specify XL Fortran runtime option settings by using the following environment variables: `XLFRTEOPTS` and `XLSMPOPTS`.

The XLFRTEOPTS environment variable

The `XLFRTEOPTS` environment variable allows you to specify options that affect the runtime behavior of items such as I/O, EOF error-handling, the specification of random-number generators, and more. You can declare `XLFRTEOPTS` by using the following `bash` command format:

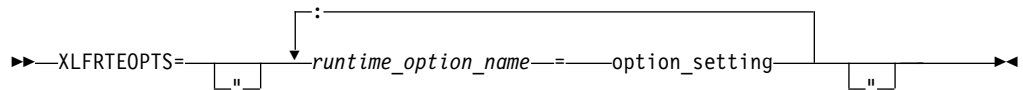

You can specify option names and settings in uppercase or lowercase. You can add blanks before and after the colons and equal signs to improve readability. However, if the `XLFRTEOPTS` option string contains imbedded blanks, you must enclose the entire option string in double quotation marks (").

The environment variable is checked when the program first encounters one of the following conditions:

- An I/O statement is executed.
- The `RANDOM_SEED` procedure is executed.
- An `ALLOCATE` statement needs to issue a runtime error message.
- A `DEALLOCATE` statement needs to issue a runtime error message.
- The multithreaded implementation of the `MATMUL` procedure is executed.

Changing the `XLFRTEOPTS` environment variable during the execution of a program has no effect on the program.

The **SETRTEOPTS** procedure (which is defined in the *XL Fortran Language Reference*) accepts a single-string argument that contains the same name-value pairs as the **XLFRTEOPTS** environment variable. It overrides the environment variable and can be used to change settings during the execution of a program. The new settings remain in effect for the rest of the program unless changed by another call to **SETRTEOPTS**. Only the settings that you specified in the procedure call are changed.

You can specify the following runtime options with the **XLFRTEOPTS** environment variable or the **SETRTEOPTS** procedure:

aggressive_array_io={yes | no}

Controls whether or not the XL Fortran run time will take advantage of descriptor information when deciding to apply slower or faster algorithms to do array I/O operations. Descriptor information that specifies an array or array section as contiguous can be used to apply the faster algorithms which would otherwise be unsafe if the array or array section was not contiguous. The default is to perform aggressive array I/O operations.

Code executing under the current XL Fortran runtime but compiled with older XL Fortran compilers can cause the aggressive array I/O operations to be unsafe if the older compilers did not set the XL Fortran descriptor information correctly. This can be a problem with code built with old XL Fortran compilers no longer in service or built with XL Fortran compilers not at the latest service levels. Older code should be recompiled, if possible, with the current compiler instead of relying on the use of this option.

buffering={enable | disable_preconn | disable_all}

Determines whether the XL Fortran runtime library performs buffering for I/O operations.

The library reads data from, or writes data to the file system in chunks for **READ** or **WRITE** statements, instead of piece by piece. The major benefit of buffering is performance improvement.

If you have applications in which Fortran routines work with routines in other languages or in which a Fortran process works with other processes on the same data file, the data written by Fortran routines may not be seen immediately by other parties (and vice versa), because of the buffering. Also, a Fortran **READ** statement may read more data than it needs into the I/O buffer and cause the input operation performed by a routine in other languages or another process that is supposed to read the next data item to fail. In these cases, you can use the **buffering** runtime option to disable the buffering in the XL Fortran runtime library. As a result, a **READ** statement will read in exactly the data it needs from a file and the data written by a **WRITE** statement will be flushed out to the file system at the completion of the statement.

Note: I/O buffering is always enabled for files on sequential access devices (such as pipes, terminals, sockets). The setting of the **buffering** option has no effect on these types of files.

If you disable I/O buffering for a logical unit, you do not need to flush the contents of the I/O buffer for that logical unit with the **FLUSH** statement or the Fortran service routine **flush_**.

The suboptions for **buffering** are as follows:

enable

The Fortran runtime library maintains an I/O buffer for each connected logical unit. The current read-write file pointers that the

runtime library maintains might not be synchronized with the read-write pointers of the corresponding files in the file system.

disable_preconn

The Fortran runtime library does not maintain an I/O buffer for each preconnected logical unit (0, 5, and 6). However, it does maintain I/O buffers for all other connected logical units. The current read-write file pointers that the runtime library maintains for the preconnected units are the same as the read-write pointers of the corresponding files in the file system.

disable_all

The Fortran runtime library does not maintain I/O buffers for any logical units. You should not specify the **buffering=disable_all** option with Fortran programs that perform asynchronous I/O.

In the following example, Fortran and C routines read a data file through redirected standard input. First, the main Fortran program reads one integer. Then, the C routine reads one integer. Finally, the main Fortran program reads another integer.

Fortran main program:

```
integer(4) p1,p2,p3
print *, 'Reading p1 in Fortran...'
read(5,*) p1
call c_func(p2)
print *, 'Reading p3 in Fortran...'
read(5,*) p3
print *, 'p1 p2 p3 Read: ', p1,p2,p3
end
```

C subroutine (c_func.c):

```
#include <stdio.h>
void
c_func(int *p2)
{
    int n1 = -1;

    printf("Reading p2 in C...\n");
    setbuf(stdin, NULL); /* Specifies no buffering for stdin */
    fscanf(stdin, "%d", &n1);
    *p2=n1;
    fflush(stdout);
}
```

Input data file (infile):

```
11111
22222
33333
44444
```

The main program runs by using infile as redirected standard input, as follows:

```
$ main < infile
```

If you turn on **buffering=disable_preconn**, the results are as follows:

```
Reading p1 in Fortran...
Reading p2 in C...
Reading p3 in Fortran...
p1 p2 p3 Read: 11111 22222 33333
```

If you turn on **buffering=enable**, the results are unpredictable.

buffer_size=size

Specifies the size of I/O buffers in bytes instead of using the block size of devices. *size* must be either -1 or an integer value that is greater than or equal to 4096. The default, -1, uses the block size of the device where the file resides.

Using this option can reduce the amount of memory used for I/O buffers when an application runs out of memory because the block size of devices is very large and the application opens many files at the same time.

Note the following when using this runtime option:

- Preconnected units remain unaffected by this option. Their buffer size is the same as the block size of the device where they reside except when the block size is larger than 64KB, in which case the buffer size is set to 64KB.
- This runtime option does not apply to files on a tape device or logical volume.
- Specifying the buffer size with the **SETRTEOPTS** procedure overrides any value previously set by the **XLFRTEOPTS** environment variable or **SETRTEOPTS** procedure. The resetting of this option does not affect units that have already been opened.

cnvrr={yes | no}

If you set this runtime option to **no**, the program does not obey the **IOSTAT=** and **ERR=** specifiers for I/O statements that encounter conversion errors. Instead, it performs default recovery actions (regardless of the setting of **err_recovery**) and may issue warning messages (depending on the setting of **xrf_messages**).

Related information: For more information about conversion errors, see *Data transfer statements* in the *XL Fortran Language Reference*. For more information about **IOSTAT** values, see *Conditions and IOSTAT values* in the *XL Fortran Language Reference*.

cpu_time_type={usertime | systime | alltime | total_usertime | total_systime | total_alltime}

Determines the measure of time returned by a call to **CPU_TIME(TIME)**.

The suboptions for **cpu_time_type** are as follows:

usertime

Returns the user time of a process.

systime

Returns the system time of a process.

alltime

Returns the sum of the user and system time of a process.

total_usertime

Returns the total user time of a process. The total user time is the sum of the user time of a process and the total user times of its child processes, if any.

total_systime

Returns the total system time of a process. The total system time is the sum of the system time of the current process and the total system times of its child processes, if any.

total_alltime

Returns the total user and system time of a process. The total user and

system time is the sum of the user and system time of the current process and the total user and system times of their child processes, if any.

default_recl={64 | 32}

Allows you to determine the default record size for sequential files opened without a **RECL=** specifier. The suboptions are as follows:

- 64** Uses a 64-bit value as the default record size.
- 32** Uses a 32-bit value as the default record size.

Use **default_recl** when porting 32-bit programs to 64-bit mode where a 64-bit record length will not fit into the specified integer variable. Consider the following:

```
INTEGER(4) I
OPEN (11)
INQUIRE (11, RECL=i)
```

A runtime error occurs in the above code sample when **default_recl=64**, since the default record length of $2^{63}-1$ does not fit into the 4-byte integer I. Specifying **default_recl=32** ensures a default record size of $2^{31}-1$, which fits into I.

For more information on the **RECL=** specifier, see the **OPEN** statement in the *XL Fortran Language Reference*.

errloc={yes | no}

Controls whether the file name and line number are displayed with an error message if a runtime error condition occurs during an I/O, **ALLOCATE** or **DEALLOCATE** statement. By default, the line number and file name appear prepended to the runtime error messages. If **errloc=no** is specified, runtime error messages are displayed without the source location information.

The **errloc** runtime option can be specified with the **SETRTEOPTS** procedure, as well.

erroeof={yes | no}

Determines whether the label specified by the **ERR=** specifier is to be branched to if no **END=** specifier is present when an end-of-file condition is encountered.

err_recovery={yes | no}

If you set this runtime option to **no**, the program stops if there is a recoverable error while executing an I/O statement with no **IOSTAT=** or **ERR=** specifiers. By default, the program takes some recovery action and continues when one of these statements encounters a recoverable error. Setting **cnvrr** to **yes** and **err_recovery** to **no** can cause conversion errors to halt the program.

errthrdnum={yes | no}

When **errthrdnum=yes** is in effect, XL Fortran appends to all error messages the thread number of the running thread that is specified by the **omp_get_thread_num** routine. For single-threaded programs, the thread number is 0.

If you specify **errloc=yes**, the thread number is displayed in front of the file name and line number. If the **IOMSG=** specifier is present in an I/O statement, the thread number is prefixed to the error message and the other part of the message uses the same format as displayed on Standard error.

errtrace={yes | no}

Controls whether a traceback is displayed with an error message if a runtime

error condition occurs during an I/O, **ALLOCATE** or **DEALLOCATE** statement. Specifying **errtrace=no** means runtime error messages are displayed without tracebacks.

To show more detailed information in tracebacks, compile with the **-qlinedebug** or **-g** option.

Tracebacks are not displayed if either of the following conditions is true:

- You use the **IOSTAT=**, **ERR=**, **END=**, or **EOR=** specifier in an I/O statement.
- You use the **STAT=** specifier in an **ALLOCATE** or **DEALLOCATE** statement.

For example, in the following sample code, the **ERR=** specifier is used to branch to some error handling code. Because the I/O statement causing the error specifies **ERR=**, no traceback is generated. The output is `Open error.`, although **errtrace=yes** is specified.

```
program open_error
open(unit=11, file='doesnotexist', status='old', err=200) ! no traceback
close(11)
200 print *, 'Open error.'
end
```

iostat_end={extended | 2003std}

Sets the **IOSTAT** values based on the XL Fortran definition or the Fortran 2003 Standard when end-of-file and end-of-record conditions occur. The suboptions are as follows:

extended

Sets the **IOSTAT** variables based on XL Fortran's definition of values and conditions.

2003std

Sets the **IOSTAT** variables based on Fortran 2003's definition of values and conditions.

For example, setting the **iostat_end=2003std** runtime option results in a different **IOSTAT** value from extensions being returned for the end-of-file condition

```
export XLFRTOPTS=iostat_end=2003std
character(10) ifl
integer(4) aa(3), ios
ifl = "12344321 "
read(ifl, '(3i4)', iostat=ios) aa ! end-of-file condition occurs and
! ios is set to -1 instead of -2.
```

For more information on setting and using **IOSTAT** values, see the **READ**, **WRITE**, and *Conditions and IOSTAT values* sections in the *XL Fortran Language Reference*.

intrinths={num_threads}

Specifies the number of threads for parallel execution of the **MATMUL** and **RANDOM_NUMBER** intrinsic procedures. The default value for **num_threads** when using the **MATMUL** intrinsic equals the number of processors online. The default value for **num_threads** when using the **RANDOM_NUMBER** intrinsic is equal to the number of processors online*2.

Changing the number of threads available to the **MATMUL** and **RANDOM_NUMBER** intrinsic procedures can influence performance.

langlvl={ | 90std | 95std | 2003std | 2008std | extended}

Determines the level of support for Fortran standards and extensions to the standards. The values of the suboptions are as follows:

90std Instructs the compiler to flag any extensions to the Fortran 90 standard I/O statements and formats as errors.

95std Instructs the compiler to flag any extensions to the Fortran 95 standard I/O statements and formats as errors.

2003std

Instructs the compiler to flag any extensions to the Fortran 2003 standard I/O statements and formats as errors.

For example, setting the **langlvl=2003std** runtime option results in a runtime error message.

```
integer(4) aa(100)
call setrteopts("langlvl=2003std")
...           ! Write to a unit without explicitly
...           ! connecting the unit to a file.
write(10, *) aa ! The implicit connection to a file does not
...           ! conform with Fortran 2003 behavior.
```

2008std

Instructs the compiler to accept all standard I/O statements and formats that the Fortran 2003 standard specifies, as well as any Fortran 2008 formats that XL Fortran supports. Anything else is flagged as an error.

extended

Instructs that the compiler to accept the Fortran 95 language standard, Fortran 2003 features, the Fortran 2008 features supported by XL Fortran, and extensions, effectively turning off language-level checking.

To obtain support for items that are part of the Fortran 95 standard and are available in XL Fortran (such as namelist comments), you must specify one of the following suboptions:

- **95std**
- **2003std**
- **2008std**
- **extended**

The following example contains a Fortran 95 extension (the *file* specifier is missing from the **OPEN** statement):

```
program test1

call setrteopts("langlvl=95std")
open(unit=1,access="sequential",form="formatted")

10 format(I3)

write(1,fmt=10) 123

end
```

Specifying **langlvl=95std** results in a runtime error message.

The following example contains a Fortran 95 feature (namelist comments) that was not part of Fortran 90:

```
program test2

INTEGER I
LOGICAL G
NAMELIST /TODAY/G, I

call setrteopts("langlvl=95std:namelist=new")
```

```

open(unit=2,file="today.new",form="formatted", &
    & access="sequential", status="old")

read(2,nml=today)
close(2)

end

today.new:

&TODAY ! This is a comment
I = 123, G=.true. /

```

If you specify **langlvl=95std**, no runtime error message is issued. However, if you specify **langlvl=90std**, a runtime error message is issued.

The **err_recovery** setting determines whether any resulting errors are treated as recoverable or severe.

multconn={yes | no}

Enables you to access the same file through more than one logical unit simultaneously. With this option, you can read more than one location within a file simultaneously without making a copy of the file.

You can only use multiple connections within the same program for files on random-access devices, such as disk drives. In particular, you cannot use multiple connections within the same program for:

- Files have been connected for write-only (**ACTION='WRITE'**)
- Asynchronous I/O
- Files on sequential-access devices (such as pipes, terminals, sockets)

To avoid the possibility of damaging the file, keep the following points in mind:

- The second and subsequent **OPEN** statements for the same file can only be for reading.
- If you initially opened the file for both input and output purposes (**ACTION='READWRITE'**), the unit connected to the file by the first **OPEN** becomes read-only (**ACCESS='READ'**) when the second unit is connected. You must close all of the units that are connected to the file and reopen the first unit to restore write access to it.
- Two files are considered to be the same file if they share the same device and i-node numbers. Thus, linked files are considered to be the same file.

multconnio={tty | nulldev | combined | no }

Enables you to connect a device to more than one logical unit. You can then write to, or read from, more than one logical unit that is attached to the same device. The suboptions are as follows:

combined

Enables you to connect a combination of null and TTY devices to more than one logical unit.

nulldev

Enables you to connect the null device to more than one logical unit.

tty

Enables you to connect a TTY device to more than one logical unit.

Note: Using this option can produce unpredictable results.

In your program, you can now specify multiple **OPEN** statements that contain different values for the **UNIT** parameters but the same value for

the **FILE** parameters. For example, if you have a symbolic link called **mytty** that is linked to TTY device **/dev/tty**, you can run the following program when you specify the **multconnio=tty** option:

```
PROGRAM iotest
OPEN(UNIT=3, FILE='mytty', ACTION="WRITE")
OPEN(UNIT=7, FILE='mytty', ACTION="WRITE")
END PROGRAM iotest
```

Fortran preconnects units 0, 5, and 6 to the same TTY device. Normally, you cannot use the **OPEN** statement to explicitly connect additional units to the TTY device that is connected to units 0, 5, and 6. However, this is possible if you specify the **multconnio=tty** option. For example, if units 0, 5, and 6 are preconnected to TTY device **/dev/tty**, you can run the following program if you specify the **multconnio=tty** option:

```
PROGRAM iotest
! /dev/pts/2 is your current tty, as reported by the 'tty' command.
! (This changes every time you login.)
CALL SETRTEOPTS ('multconnio=tty')
OPEN (UNIT=3, FILE='/dev/pts/2')
WRITE (3, *) 'hello' ! Display 'hello' on your screen
END PROGRAM
```

namelist={new | old}

Determines whether the program uses the XL Fortran new or old **NAMELIST** format for input and output. The Fortran 90 and Fortran 95 standards require the new format.

Note: You may need the **old** setting to read existing data files that contain **NAMELIST** output. However, use the standard-compiler new format in writing any new data files.

With **namelist=old**, the nonstandard **NAMELIST** format is not considered an error by the **langlvl=90std**, **langlvl=95std**, or **langlvl=2003std** setting.

Related information: For more information about **NAMELIST** I/O, see *Namelist formatting* in the *XL Fortran Language Reference*.

naninfoutput={2003std | old | default}

Controls whether the display of IEEE exceptional values conform to the Fortran 2003 standard or revert to the old XL Fortran behavior. This runtime option allows object files created with different compilation commands to output all IEEE exceptional values based on the old behavior, or the Fortran 2003 standard. The suboptions are:

default

Exceptional values output depends on how the program is compiled.

old

Exceptional values output conforms to the old XL Fortran behavior.

2003std

Exceptional values output conforms to the Fortran 2003 standard.

nlwidth=record_width

By default, a **NAMELIST** write statement produces a single output record long enough to contain all of the written **NAMELIST** items. To restrict **NAMELIST** output records to a given width, use the **nlwidth** runtime option.

Note: The **RECL=** specifier for sequential files has largely made this option obsolete, because programs attempt to fit **NAMELIST** output within the

specified record length. You can still use **nlwidth** in conjunction with **RECL=** as long as the **nlwidth** width does not exceed the stated record length for the file.

random={generator1 | generator2}

Specifies the generator to be used by **RANDOM_NUMBER** if **RANDOM_SEED** has not yet been called with the **GENERATOR** argument. The value **generator1** (the default) corresponds to **GENERATOR=1**, and **generator2** corresponds to **GENERATOR=2**. If you call **RANDOM_SEED** with the **GENERATOR** argument, it overrides the random option from that point onward in the program. Changing the random option by calling **SETRTEOPTS** after calling **RANDOM_SEED** with the **GENERATOR** option has no effect.

scratch_vars={yes | no}

To give a specific name to a scratch file, set the **scratch_vars** runtime option to **yes**, and set the environment variable **XLFSCRATCH_unit** to the name of the file you want to be associated with the specified unit number. See *Naming scratch files* in the *XL Fortran Optimization and Programming Guide* for examples.

ufmt_bigendian={units_list}

Specifies unit numbers of unformatted data files on which big-endian I/O is to be performed. The big-endian format data in the specified unformatted files is converted, on-the-fly, during the I/O operation to and from the little-endian format used on machines where XL Fortran applications are running.

This runtime option does not work with internal files; internal files are always **FORMATTED**. Units specified must be connected by an explicit or implicit **OPEN** for the **UNFORMATTED** form of I/O.

The syntax for this option is as follows:

```
ufmt_bigendian=units_list
```

where:

```
units_list = units | units_list, units
```

```
units = unit | unit- | -unit | unit1-unit2 | newunit | *
```

The unit number must be an integer, whose value is in the range 1 through 2 147 483 647.

unit Specifies the number of the logical unit.

unit- Specifies the range of units, starting from unit number *unit* to the highest possible unit number

-unit Specifies the range of units, starting from unit number 1 to unit number *unit*.

unit1-unit2

Specifies the range of units, starting from unit number *unit1* to unit number *unit2*.

newunit

Specifies the range of all **NEWUNIT** values. For details about **NEWUNIT** values, see **NEWUNIT** value.

***** Specifies all units. It is equivalent to 1-,newunit.

Note:

1. The byte order of data of type **CHARACTER** is not swapped.

2. The compiler assumes that the internal representation of values of type **REAL*4** or **REAL*8** is IEEE floating-point format compliant. I/O may not work properly with an internal representation that is different.
3. The internal representation of values of type **REAL*16** is inconsistent among different vendors. The compiler treats the internal representation of values of type **REAL*16** to be the same as XL Fortran's. I/O may not work properly with an internal representation that is different.
4. Conversion of derived type data is not supported. The alignment of derived types is inconsistent among different vendors.
5. Discrepancies in implementations from different vendors may cause problems in exchanging the big-endian unformatted data files between XL Fortran applications running on Linux and Fortran applications running on big-endian systems. XL Fortran provides a number of options that help users port their programs to XL Fortran. If there are problems exchanging big-endian data files, check these options to see if they can help with the problem.
6. XL Fortran provides several methods of specifying the byte order of unformatted data transfer. The **ufmt_bigendian** option has the highest precedence, followed by the **CONVERT=** specifier and the **-qufmt** option. For more information, see **CONVERT=** specifier in the **OPEN** statement and **"-qufmt"** on page 257.

unit_vars={yes | no}

To give a specific name to an implicitly connected file or to a file opened with no **FILE=** specifier, you can set the runtime option **unit_vars=yes** and set one or more environment variables with names of the form **XLFUNIT_unit** to file names. See *Naming files that are connected with no explicit name* in the *XL Fortran Optimization and Programming Guide* for examples.

uwidth={32 | 64}

To specify the width of record length fields in unformatted sequential files, specify the value in bits. When the record length of an unformatted sequential file is greater than $(2^{*31} - 1)$ bytes minus 8 bytes (for the record terminators surrounding the data), you need to set the runtime option **uwidth=64** to extend the record length fields to 64 bits. This allows the record length to be up to $(2^{*63} - 1)$ minus 16 bytes (for the record terminators surrounding the data).

xrf_messages={yes | no}

To prevent programs from displaying runtime messages for error conditions during I/O operations, **RANDOM_SEED** calls, and **ALLOCATE** or **DEALLOCATE** statements, set the **xrf_messages** runtime option to **no**. Otherwise, runtime messages for conversion errors and other problems are sent to the standard error stream.

The following examples set the **cnvrr** runtime option to **yes** and the **xrf_messages** option to **no**.

```
# Basic format
XLF RTEOPTS=cnvrr=yes:xrf_messages=no
export XLF RTEOPTS

# With imbedded blanks
XLF RTEOPTS="xrf_messages = NO : cnvrr = YES"
export XLF RTEOPTS
```

As a call to **SETRTEOPTS**, this example could be:

```
CALL setrteopts('xrf_messages=NO:cverr=yes')
! Name is in lowercase in case -U (mixed) option is used.
```

Setting OMP and SMP run time options

The `XLSMPOPTS` environment variable allows you to specify options that affect SMP execution. The OpenMP environment variables, `OMP_DYNAMIC`, `OMP_NESTED`, `OMP_NUM_THREADS`, and `OMP_SCHEDULE`, allow you to control the execution of parallel code. For details on using these, see *XLSMPOPTS* and *OpenMP environment variables* sections in the *XL Fortran Optimization and Programming Guide*.

BLAS/ESSL environment variable

By default, the `libxlopt` library is linked with any application you compile with XL Fortran. However, if you are using a third-party Basic Linear Algebra Subprograms (BLAS) library or want to ship a binary file that includes ESSL routines, you must specify these using the `XL_BLAS_LIB` environment variable. For example, if your own BLAS library is called `libblas`, set the environment variable as follows:

```
export XL_BLAS_LIB=/usr/lib/libblas.a
```

When the compiler generates calls to BLAS routines, the ones defined in the `libblas` library will be used at run time instead of those defined in `libxlopt`.

XLF_USR_CONFIG

Use the `XLF_USR_CONFIG` environment variable to specify the location of a custom configuration file to be used by the compiler. The file name must be given with its absolute path. The compiler will first process the definitions in this file before processing those in the default system configuration file, or those in a customized file specified by the `-F` option; for more information, see “Using custom compiler configuration files” on page 10.

Other environment variables that affect runtime behavior

The `LD_LIBRARY_PATH`, `LD_RUN_PATH`, and `TMPDIR` environment variables have an effect at run time, as explained in “Correct settings for environment variables” on page 7. They are not XL Fortran runtime options and cannot be set in either `XLFRTEOPTS` or `XLSMPOPTS`.

XL Fortran runtime exceptions

The following operations cause runtime exceptions in the form of `SIGTRAP` signals, which typically result in a “Trace/breakpoint trap” message:

- Character substring expression or array subscript out of bounds after you specified the `-C` option at compile time.
- Lengths of character pointer and target do not match after you specified the `-C` option at compile time.
- The flow of control in the program reaches a location for which a semantic error with severity of `S` was issued when the program was compiled.
- Floating-point operations that generate NaN values and loads of the NaN values after you specify the `-qfloat=nanq` option at compile time.
- Fixed-point division by zero.
- Calls to the TRAP hardware-specific intrinsic procedure.

The following operations cause runtime exceptions in the form of `SIGFPE` signals:

- Floating-point exceptions provided you specify the appropriate `-qfltrap` suboptions at compile time.

If you install one of the predefined XL Fortran exception handlers before the exception occurs, a diagnostic message and a traceback showing the offset within each routine called that led to the exception are written to standard error after the exception occurs. The file buffers are also flushed before the program ends. If you compile the program with the `-g` option, the traceback shows source line numbers in addition to the address offsets.

You can use a symbolic debugger to determine the error. `gdb` provides a specific error message that describes the cause of the exception.

Related information:

- “-C” on page 72
- “-qfltrap” on page 138
- “-qsigtrap” on page 228

Also see the following topics in the *XL Fortran Optimization and Programming Guide*:

- *Detecting and trapping floating-point exceptions* for more details about these exceptions
- *Controlling the floating-point status and control register* for a list of exception handlers.

Chapter 5. Summary of compiler options by functional category

The XL Fortran options available on the Linux platform are grouped into the following categories:

- “Output control”
- “Input control” on page 53
- “Language element control” on page 54
- “Floating-point and integer control” on page 56
- “Object code control” on page 57
- “Error checking and debugging” on page 58
- “Listings, messages, and compiler information” on page 60
- “Optimization and tuning” on page 62
- “Linking” on page 65
- “Portability and migration” on page 66
- “Compiler customization” on page 67

If the option supports an equivalent @PROCESS directive, this is indicated. To get detailed information on any option listed, see the full description page for that option.

You can enter compiler options that start with **-q**, suboptions, and @PROCESS directives in either uppercase or lowercase. However, note that if you specify the **-qmixed** option, procedure names that you specify for the **-qextern** option are case-sensitive.

In general, this document uses the convention of lowercase for **-q** compiler options and suboptions and uppercase for @PROCESS directives.

Understanding the significance of the options you use and knowing the alternatives available can save you considerable time and effort in making your programs work correctly and efficiently.

For detailed information about each compiler option, see Chapter 6, “Detailed descriptions of the XL Fortran compiler options,” on page 69.

Output control

The options in this category control the type of file output the compiler produces, as well as the locations of the output. These are the basic options that determine the compiler components that will be invoked, the preprocessing, compilation, and linking steps that will (or will not) be taken, and the kind of output to be generated.

Table 7. Compiler output options

Option name	@PROCESS directive	Description
“-c” on page 73	None.	Instructs the compiler to compile or assemble the source files only but do not link. With this option, the output is a .o file for each source file.

Table 7. Compiler output options (continued)

Option name	@PROCESS directive	Description
"-d" on page 74	None.	Causes preprocessed source files that are produced by cpp to be kept rather than deleted.
"-MMD" on page 84	None.	Produces a dependency output file containing targets suitable for inclusion in a description file for the make command. -MMD is the short form of "-qmakedep" on page 185.
"-MF" on page 83	None.	Specifies the name or location for the dependency output files that are generated by the -qmakedep or -MMD option.
"-MT" on page 85	None.	Specifies the target name of the object file in the make rule in the dependency output file that is generated by the -qmakedep or -MMD option.
"-o" on page 89	None.	Specifies a name for the output object, assembler, or executable file.
"-qmakedep" on page 185	None.	Produces a dependency output file containing targets suitable for inclusion in a description file for the make command. -qmakedep is the long form of "-MMD" on page 84.
"-qmkshrobj" on page 192	None.	Creates a shared object from generated object files.
"-qmoddir" on page 193	None.	Specifies the location for any module (.mod) or F2008 submodule F2008 (.smod) files that the compiler writes.
"-qtimestamps" on page 254	None.	Controls whether or not implicit time stamps are inserted into an object file.
"-S" on page 278	None.	Generates an assembler language file for each source file.

Input control

The options in this category specify the type and location of your source files.

Table 8. Compiler input options

Option name	@PROCESS directive	Description
"-D" on page 73, "-qdlines" on page 123	DLINES	Specifies whether the compiler compiles fixed source form lines with a D in column 1 or treats them as comments.
"-I" on page 80	None.	Adds a directory to the search path for include files, .mod files, and .smod files.
"-qcclines" on page 107	CCLINES	Determines whether the compiler recognizes conditional compilation lines in fixed source form and F90 free source form. This option is not supported with IBM free source form.
"-qci" on page 110	CI	Specifies the identification numbers (from 1 to 255) of the INCLUDE lines to process.
"-qcr" on page 112	None.	Controls how the compiler interprets the CR (carriage return) character.
"-qdirective" on page 120	DIRECTIVE	Specifies sequences of characters, known as trigger constants, that identify comment lines as compiler comment directives.
"-qfixed" on page 131	FIXED	Indicates that the input source program is in fixed source form and optionally specifies the maximum line length.
"-qfpp" on page 137	None.	Controls Fortran-specific preprocessing in the C preprocessor. This is a C preprocessor option, and must therefore be specified using the -WF option.
"-qfree" on page 140	FREE	Indicates that the source code is in free source form.
"-qmixed" on page 191, "-U" on page 280	MIXED	Makes the compiler sensitive to the case of letters in names.

Table 8. Compiler input options (continued)

Option name	@PROCESS directive	Description
"-qppsuborigarg" on page 213	None.	Instructs the C preprocessor to substitute original macro arguments before further macro expansion. This is a C preprocessor option, and must therefore be specified using the -WF option.
"-qsuffix" on page 248	None.	Specifies the source-file suffix on the command line.
"-qxlines" on page 274	XLINES	Specifies whether fixed source form lines with an X in column 1 are compiled or treated as comments.

Language element control

The options in this category allow you to specify the characteristics of the source code. You can also use these options to enforce or relax language restrictions and enable or disable language extensions.

Table 9. Language element control options

Option name	@PROCESS directive	Description
"-qaltivec" on page 96	ALTIVEC	Specifies the order of vector elements in vector registers.
"-qcuda (CUDA Fortran)" on page 114	None.	Enables the compiler support for CUDA Fortran.
"-qinit" on page 158	INIT(F90PTR)	Makes the initial association status of pointers disassociated.
"-qlanglvl" on page 175	LANGLVL	Determines which language standard (or superset, or subset of a standard) to consult for nonconformance. It identifies nonconforming source code and also options that allow such nonconformances.
"-qmbs" on page 191	MBCS	Indicates to the compiler whether character literal constants, Hollerith constants, H edit descriptors, and character string edit descriptors can contain Multibyte Character Set (MBCS) or Unicode characters.
"-qnullterm" on page 194	NULLTERM	Appends a null character to each character constant expression that is passed as a dummy argument, making it more convenient to pass strings to C functions.

Table 9. Language element control options (continued)

Option name	@PROCESS directive	Description
"-1" on page 71, "-qonetrip" on page 198	ONETRIP	Executes each DO loop in the compiled program at least once if its DO statement is executed, even if the iteration count is 0. This option provides compatibility with FORTRAN 66.
"-qposition" on page 212	POSITION	Positions the file pointer at the end of the file when data is written after an OPEN statement with no POSITION= specifier and the corresponding STATUS= value (OLD or UNKNOWN) is specified.
"-qqcount" on page 216	QCOUNT	Accepts the Q character-count edit descriptor (Q) as well as the extended-precision Q edit descriptor (Qw.d).
"-qsaa" on page 222	SAA	Checks for conformance to the SAA FORTRAN language definition. It identifies nonconforming source code and also options that allow such nonconformances.
"-qsave" on page 223	SAVE	Specifies the default storage class for local variables.
"-qsclk" on page 226	None.	Specifies the resolution that the SYSTEM_CLOCK intrinsic procedure uses in a program.
"-u" on page 281, "-qundef" on page 258	UNDEF	Specifies that no implicit typing of variable names is permitted. -qundef is the long form of the "-u" on page 281 option.
"-qxf77" on page 266	XLF77	Provides compatibility with FORTRAN 77 aspects of language semantics and I/O data format that have changed.
"-qxf90" on page 268	XLF90	Provides compatibility with the Fortran 90 standard for certain aspects of the Fortran language.

Table 9. Language element control options (continued)

Option name	@PROCESS directive	Description
"-qxf2003" on page 270	XLF2003	Provides the ability to use language features specific to the Fortran 2003 standard when compiling with compiler invocations that conform to earlier Fortran standards, as well as the ability to disable these features when compiling with compiler invocations that conform to the Fortran 2003 standard.
"-qxf2008" on page 273	XLF2008	Provides the ability to use language features specific to the Fortran 2008 standard when compiling with compiler invocations that conform to earlier Fortran standards, as well as the ability to disable these features when compiling with compiler invocations that conform to the Fortran 2008 standard.
"-qzerosize" on page 277	ZEROSIZE	Determines whether checking for zero-sized character strings and arrays takes place in programs that might process such objects.

Floating-point and integer control

Specifying the details of how your applications perform calculations can allow you to take better advantage of your system's floating-point performance and precision, including how to direct rounding. However, keep in mind that strictly adhering to IEEE floating-point specifications can impact the performance of your application. Using the options in the following table, you can control trade-offs between floating-point performance and adherence to IEEE standards. Some of these options also allow you to control certain aspects of integer calculations.

Table 10. Floating-point and integer control options

Option name	@PROCESS directive	Description
"-qautodbl" on page 101	AUTODBL	Provides an automatic means of converting single-precision floating-point calculations to double-precision and of converting double-precision calculations to extended-precision.
"-qdpc" on page 123	DPC	Increases the precision of real constants for maximum accuracy, when assigning real constants to DOUBLE PRECISION variables.
"-qenum" on page 124	None.	Specifies the range of the enumerator constant and enables storage size to be determined.

Table 10. Floating-point and integer control options (continued)

Option name	@PROCESS directive	Description
"-qfloat" on page 134	FLOAT	Selects different strategies for speeding up or improving the accuracy of floating-point calculations.
"-qieee" on page 152, "-y" on page 285	IEEE	Specifies the rounding mode that the compiler will use when it evaluates constant floating-point expressions at compile time.
"-qintlog" on page 166	INTLOG	Specifies that you can mix integer and logical data entities in expressions and statements.
"-qintsize" on page 167	INTSIZE	Sets the size of default INTEGER and LOGICAL data entities that have no length or kind specified.
"-qrealsize" on page 217	REALSIZE	Sets the default size of REAL , DOUBLE PRECISION , COMPLEX , and DOUBLE COMPLEX values.
"-qstrictieemod" on page 246	STRICTIEEMOD	Specifies whether the compiler will adhere to the Fortran 2003 IEEE arithmetic rules for the ieee_arithmetic and ieee_exceptions intrinsic modules.

Object code control

These options affect the characteristics of the object code, preprocessed code, or other output generated by the compiler.

Table 11. Object code control options

Option name	@PROCESS directive	Description
"-qinlglue" on page 163	INLGLUE	When used with -O2 or higher optimization, inlines glue code that optimizes external function calls in your application.
"-qpic" on page 209	None.	Generates position-independent code required for use in shared libraries.

Table 11. Object code control options (continued)

Option name	@PROCESS directive	Description
"-qsaveopt" on page 224	None.	Saves the command-line options used for compiling a source file, the user's configuration file name and the options specified in the configuration files, the version and level of each compiler component invoked during compilation, and other information to the corresponding object file.
"-qtbtable" on page 252	None.	Controls the amount of debugging traceback information that is included in the object files.
"-qthreaded" on page 253	None.	Indicates to the compiler whether it must generate threadsafe code.

Error checking and debugging

The options in the following table allow you to detect and correct problems in your source code. In some cases, these options can alter your object code, increase your compile time, or introduce runtime checking that can slow down the execution of your application. The option descriptions indicate how extra checking can impact performance.

To control the amount and type of information you receive regarding the behavior and performance of your application, consult "Listings, messages, and compiler information" on page 60.

For information about debugging optimized code, see the *XL Fortran Optimization and Programming Guide*.

Table 12. Error checking and debugging options

Option name	@PROCESS directive	Description
"-#" on page 70	None.	Previews the compilation steps specified on the command line, without actually invoking any compiler components.
"-C" on page 72, "-qcheck" on page 107	CHECK	Generates code that performs certain types of runtime checking.
"-qcudaerr (CUDA Fortran)" on page 115	CUDAERR	Controls whether the compiler automatically inserts error checking code for CUDA API calls.
"-g" on page 77, "-qdbg" on page 117	DBG	Generates debugging information for use by a symbolic debugger, and makes the program state available to the debugging session at selected source locations.

Table 12. Error checking and debugging options (continued)

Option name	@PROCESS directive	Description
"-qfltrap" on page 138	FLTRAP	Determines what types of floating-point exception conditions to detect at run time.
"-qfullpath" on page 141	None.	When used with the -g or -qlinedebug option, this option records the full, or absolute, path names of source and include files in object files compiled with debugging information, so that debugging tools can correctly locate the source files.
"-qfunctrace" on page 142	None.	Traces entry and exit points of procedures in your program. If your program contains C++ compilation units, this option also traces C++ catch blocks.
"-qfunctrace_xlf_catch" on page 144	None.	Specifies the name of the catch tracing subroutine.
"-qfunctrace_xlf_enter" on page 145	None.	Specifies the name of the entry tracing subroutine.
"-qfunctrace_xlf_exit" on page 146	None.	Specifies the name of the exit tracing subroutine.
"-qhalt" on page 147	HALT	Stops compilation before producing any object, executable, or assembler source files if the maximum severity of compile-time messages equals or exceeds the severity you specify.
"-qhaltonmsg" on page 148	HALTONMSG	Stops compilation before producing any object files, executable files, or assembler source files if a specified error message is generated.
"-qinfo" on page 153	None.	Produces or suppresses groups of informational messages.
"-qinitalloc" on page 158	INITALLOC	Initializes allocatable and pointer variables that are allocated but not initialized to a specific value, for debugging purposes.
"-qinitauto" on page 160	None.	Initializes uninitialized automatic variables to a specific value, for debugging purposes.
"-qkeepparm" on page 174	None.	When used with -O2 or higher optimization, specifies whether procedure parameters are stored on the stack.
"-qlinedebug" on page 179	None.	Generates only line number and source file name information for a debugger.

Table 12. Error checking and debugging options (continued)

Option name	@PROCESS directive	Description
"-qobject" on page 196	OBJECT	Specifies whether to produce an object file or to stop immediately after checking the syntax of the source files.
"-qsigtrap" on page 228	None.	Sets up the specified trap handler to catch SIGTRAP and SIGFPE exceptions when compiling a file that contains a main program.
"-qstackprotect" on page 238	None.	Provides protection against malicious input data or programming errors that overwrite or corrupt the stack.
"-qwarn64" on page 263	None.	Displays informational messages identifying statements that may cause problems with 32-bit to 64-bit migration.
"-qxflag=dvz" on page 264	None.	Causes the compiler to generate code to detect floating-point divide-by-zero operations.

Listings, messages, and compiler information

The options in the following table allow your control over the listing file, as well as how and when to display compiler messages. You can use these options in conjunction with those described in "Error checking and debugging" on page 58 to provide a more robust overview of your application when checking for errors and unexpected behavior.

Table 13. Listings and messages options

Option name	@PROCESS directive	Description
"-qattr" on page 100	ATTR	Produces a compiler listing that includes the attribute component of the attribute and cross-reference section of the listing.
"-qflag" on page 132	FLAG	Limits the diagnostic messages to those of a specified severity level or higher.
"-qhelp" on page 149	None.	Displays the man page of the compiler.
"-qlist" on page 180	LIST	Produces a compiler listing file that includes object and constant area sections.

Table 13. Listings and messages options (continued)

Option name	@PROCESS directive	Description
"-qlistfmt" on page 181	None.	Creates a report in XML or HTML format to help you find optimization opportunities.
"-qlistopt" on page 184	None.	Produces a compiler listing file that includes all options in effect at the time of compiler invocation.
"-qmaxerr" on page 188	MAXERR	Stops compilation when the number of error messages of a specified severity level or higher reaches a specified number.
"-qphsinfo" on page 207	PHSINFO	Reports the time taken in each compilation phase to standard output.
"-qnoprint" on page 194	None.	Prevents the compiler from creating the listing file, regardless of the settings of other listing options.
"-qreport" on page 220	None.	Produces listing files that show how sections of code have been optimized.
"-qslmtags" on page 230	None.	Controls whether SLM Tags logging tracks compiler license usage.
"-qsource" on page 236	SOURCE	Produces a compiler listing file that includes the source section of the listing and provides additional source information when printing error messages.
"-qsuppress" on page 249	None.	Prevents specific informational or warning messages from being displayed or added to the listing file, if one is generated.
"-qversion" on page 260	None.	Displays the version and release of the compiler being invoked.
"-V" on page 282	None.	The same as -v except that you can cut and paste directly from the display to create a command.
"-v" on page 281	None.	Reports the progress of compilation, by naming the programs being invoked and the options being specified to each program.

Table 13. Listings and messages options (continued)

Option name	@PROCESS directive	Description
"-w" on page 282	None.	Suppresses warning messages (equivalent to -qflag=e:e).
"-qxref" on page 276	XREF	Produces a compiler listing that includes the cross-reference component of the attribute and cross-reference section of the listing.

Optimization and tuning

You can control the optimization and tuning process, which can improve the performance of your application at run time, using the options in the following table. Remember that not all options benefit all applications. Trade-offs sometimes occur between an increase in compile time, a reduction in debugging capability, and the improvements that optimization can provide. In addition to the option descriptions in this section, consult the *XL Fortran Optimization and Programming Guide* for details on the optimization and tuning process as well as writing optimization friendly source code.

Some of the options in "Floating-point and integer control" on page 56 can also improve performance, but you must use them with care to ensure your application retains the floating-point semantics it requires.

Table 14. Optimization and tuning options

Option name	@PROCESS directive	Description
"-qalias" on page 91	ALIAS(<i>argument_list</i>)	Indicates whether a program contains certain categories of aliasing or does not conform to Fortran standard aliasing rules. The compiler limits the scope of some optimizations when there is a possibility that different names are aliases for the same storage location.
"-qarch" on page 97	None.	Specifies the processor architecture, or family of architectures, where the code may run. This allows the compiler to take maximum advantage of the machine instructions specific to an architecture, or common to a family of architectures.
"-qassert" on page 99	ASSERT	Provides information about the characteristics of your code that can help the compiler fine-tune optimizations.
"-qcache" on page 104	None.	Specifies the cache configuration for a specific execution machine.

Table 14. Optimization and tuning options (continued)

Option name	@PROCESS directive	Description
"-qcompact" on page 111	COMPACT	Avoids optimizations that increase code size.
"-qdirectstorage" on page 122	None.	Informs the compiler that a given compilation unit may reference write-through-enabled or cache-inhibited storage.
"-qessl" on page 127	None.	Allows the compiler to substitute the Engineering and Scientific Subroutine Library (ESSL) routines in place of Fortran 90 intrinsic procedures.
"-qfdpr" on page 130	None.	Provides object files with information that the IBM Feedback Directed Program Restructuring (FDPR [®]) performance-tuning utility needs to optimize the resulting executable file.
"-qhot" on page 149	HOT(<i>suboptions</i>)	Performs high-order loop analysis and transformations (HOT) during optimization.
-qinline	None.	Attempts to inline procedures instead of generating calls to those procedures, for improved performance.
"-qipa" on page 169	None.	Enables or customizes a class of optimizations known as interprocedural analysis (IPA).
"-qlibansi" on page 177	None.	Assumes that all functions with the name of an ANSI C library function are, in fact, the library functions and not a user function with different semantics.
-qlibmpi	None.	Asserts that all functions with Message Passing Interface (MPI) names are in fact MPI functions and not a user function with different semantics.
"-qmaxmem" on page 189	MAXMEM	Limits the amount of memory that the compiler allocates while performing specific, memory-intensive optimizations to the specified number of kilobytes.
"-O" on page 87	OPTIMIZE	Specifies whether to optimize code during compilation and, if so, at which level.
 "-qoffload" on page 197	None.	Enables support for offloading OpenMP target regions to an NVIDIA GPU.

Table 14. Optimization and tuning options (continued)

Option name	@PROCESS directive	Description
"-p" on page 90	None.	Prepares the object files produced by the compiler for profiling.
"-qpdf1, -qpdf2" on page 202	None.	Tunes optimizations through <i>profile-directed feedback</i> (PDF), where results from sample program execution are used to improve optimization near conditional branches and in frequently executed code sections.
"-qprefetch" on page 214	None.	Inserts prefetch instructions automatically where there are opportunities to improve code performance.
"-qshowpdf" on page 227	None.	When used with -qpdf1 and a minimum optimization level of -O2 at compile and link steps, creates a PDF map file that contains additional profiling information for all procedures in your application.
"-qsimd" on page 229	None.	Controls whether the compiler can automatically take advantage of vector instructions for processors that support them.
"-qsmallstack" on page 231	None.	Minimizes stack usage where possible.
"-qsmp" on page 232	None.	Enables parallelization of program code.
"-qstacktemp" on page 239	None.	Determines where to allocate certain XL Fortran compiler temporaries at run time.
"-qstrict" on page 242	STRICT	Ensures that optimizations that are done by default at the -O3 and higher optimization levels, and, optionally at -O2 , do not alter certain program semantics mostly related to strict IEEE floating-point conformance.
"-qstrict_induction" on page 247	None.	Prevents the compiler from performing induction (loop counter) variable optimizations. These optimizations may be unsafe (may alter the semantics of your program) when there are integer overflow operations involving the induction variables.

Table 14. Optimization and tuning options (continued)

Option name	@PROCESS directive	Description
"-qtune" on page 255	None.	Tunes instruction selection, scheduling, and other architecture-dependent performance enhancements to run best on a specific hardware architecture. Allows specification of a target SMT mode to direct optimizations for best performance in that mode.
"-qunroll" on page 258	None.	Specifies whether unrolling DO loops is allowed in a program. Unrolling is allowed on outer and inner DO loops.
"-qunwind" on page 260	None.	Specifies that the compiler will preserve the default behavior for saves and restores to volatile registers during a procedure call.
"-qvisibility" on page 262	VISIBILITY(<i>suboption</i>)	Specifies the visibility attribute for external linkage symbols in object files.

Linking

Though linking occurs automatically, the options in the following table allow you to direct input and output to the linker, controlling how the linker processes your object files.

You can actually include **ld** options on the compiler command line, because the compiler passes unrecognized options on to the linker.

Table 15. Linking options

Option name	@PROCESS directive	Description
"-e" on page 74	None.	When used together with the -qmksbobj option, specifies an entry point for a shared object.
"-L" on page 82	None.	At link time, searches the directory path for library files specified by the -l option.
"-l" on page 82	None.	Searches for the specified library file. The linker searches for <i>libkey.so</i> , and then <i>libkey.a</i> if <i>libkey.so</i> is not found.
"-qstaticlink" on page 240	None.	Controls whether static or shared runtime libraries are linked into an application.

Portability and migration

The options in this category can help you maintain application behavior compatibility on past, current, and future hardware, operating systems and compilers, or help move your applications to an XL compiler with minimal change.

Table 16. Portability and migration options

Option name	@PROCESS directive	Description
"-qalign" on page 94	ALIGN	Specifies the alignment of data objects in storage, which avoids performance problems with misaligned data.
"-qbindcextname" on page 103	BINDCEXTNAME	Controls whether the -qextname option affects BIND(C) entities.
"-qctyplss" on page 113	CTYPLSS	Specifies whether character constant expressions are allowed wherever typeless constants may be used.
"-qddim" on page 118	DDIM	Specifies that the bounds of pointer arrays are re-evaluated each time the arrays are referenced and removes some restrictions on the bounds expressions for pointer arrays.
"-qdescriptor" on page 119	None.	Specifies the XL Fortran internal descriptor data structure format to use for non object-oriented entities in your compiled applications.
"-qescape" on page 125	ESCAPE	Specifies how the backslash is treated in character strings, Hollerith constants, H edit descriptors, and character string edit descriptors.
"-qextern" on page 128	None.	Allows user-written procedures to be called instead of XL Fortran intrinsics.
"-qextname" on page 129	EXTNAME	Adds an underscore to the names of all global entities.
"-qlog4" on page 184	LOG4	Specifies whether the result of a logical operation with logical operands is a LOGICAL(4) or is a LOGICAL with the maximum length of the operands.
"-qport" on page 209	PORT	Provides options to accommodate other Fortran language extensions when porting programs to XL Fortran.
"-qswapomp" on page 251	SWAPOMP	Specifies that the compiler should recognize and substitute OpenMP routines in XL Fortran programs.

Table 16. Portability and migration options (continued)

Option name	@PROCESS directive	Description
"-qufmt" on page 257	UFMT	Sets the byte order for I/O operations on unformatted data files.
"-qxflag=oldtab" on page 265	XFLAG(OLDTAB)	Interprets a tab in columns 1 to 5 as a single character (for fixed source form programs).

Compiler customization

The options in the following table allow you to specify alternative locations for compiler components, configuration files, standard include directories, and internal compiler operation. These options are useful for specialized installations, testing scenarios, and the specification of additional command-line options.

Table 17. Compiler customization options

Option name	@PROCESS directive	Description
"-B" on page 71	None.	Specifies substitute path names for XL Fortran components such as the assembler, C preprocessor, and linker.
"-F" on page 75	None.	Specifies an alternative configuration file, which stanza to use within the configuration file, or both.
"-NS" on page 86, "-qspillsize" on page 237	SPILLSIZE	Specifies the size (in bytes) of the register spill space; the internal program storage areas used by the optimizer for register spills to storage.
"-qoptfile" on page 198	None.	Specifies a file containing a list of additional command line options to be used for the compilation.
"-qpath" on page 201	None.	Specifies substitute path names for XL Fortran components such as the assembler, C preprocessor, and linker.
"-t" on page 279	None.	Applies the prefix specified by the -B option to the designated components.
"-W, -X" on page 283	None.	Passes one or more options to a component that is executed during compilation.

Chapter 6. Detailed descriptions of the XL Fortran compiler options

This section contains descriptions of the individual options available in XL Fortran.

For each option, the following information is provided:

Category

The functional category to which the option belongs is listed here.

@PROCESS

For many compiler options, you can use an equivalent @PROCESS directive to apply the option's functionality within the source code, limiting the scope of the option's application to a single source file or compilation unit, or even selected sections of code.

Purpose

This section provides a brief description of the effect of the option (and equivalent directives), and why you might want to use it.

Syntax

This section provides the syntax for the command-line option and for the equivalent @PROCESS directive, if applicable. Syntax is shown first in command-line form, and then in @PROCESS form. For an explanation of the notations used to represent command-line syntax, see "Conventions" on page viii.

Uppercase letters are sometimes used to indicate the minimum number of characters for an option. For example, in **-qassert=CONTIGuous**, the uppercase letters **CONTIG** indicate the minimum number of characters you must use for this option. Therefore if you use **-qassert=contig** or **-qassert=contigu**, the compiler recognizes both as valid.

For @PROCESS syntax, the following notations are used:

- Defaults for each option are underlined and in boldface type.
- Individual required arguments are shown with no special notation.
- When you must make a choice between a set of alternatives, they are enclosed by { and } symbols.
- Optional arguments are enclosed by [and] symbols.
- When you can select from a group of choices, they are separated by | characters.
- Arguments that you can repeat are followed by ellipses (...).

Defaults

In most cases, the default option setting is clearly indicated in the syntax diagram. However, for many options, there are multiple default settings, depending on other compiler options in effect. This section indicates the different defaults that may apply.

Parameters

This section describes the suboptions that are available for the option.

Usage This section describes any rules or usage considerations you should be aware of. These can include restrictions on the option's applicability, precedence rules for multiple option specifications, and so on.

Examples

Where appropriate, examples of the command-line syntax and use are provided in this section.

-#

Category

Error checking and debugging

@PROCESS

None.

Purpose

Previews the compilation steps specified on the command line, without actually invoking any compiler components.

At the points where the compiler executes commands to perform different compilation steps, this option displays a simulation of the commands it would run and the system argument lists it would pass, but it does not actually perform these actions.

Syntax

Option:

►► -# ◄◄

Defaults

Not applicable.

Usage

Examining the output of this option can help you quickly and safely determine the following information for a particular compilation:

- What files are involved
- What options are in effect for each step

It avoids the overhead of compiling the source code and avoids overwriting any existing files, such as `.lst` files. (If you are familiar with the `make` command, it is similar to `make -n`.)

This option produces the same output as `-v` and `-V`, but does not perform the compilation.

Note that if you specify this option with `-qipa`, the compiler does not display linker information subsequent to the IPA link step. This is because the compiler does not actually call IPA.

Related information

- “`-v`” on page 281
- “`-V`” on page 282

-1

Category

Language element control

Purpose

Executes each **DO** loop in the compiled program at least once if its **DO** statement is executed, even if the iteration count is 0. This option provides compatibility with FORTRAN 66.

`-qonetrip` is the long form of `-1`.

Syntax

Option:

►► `-1` _____ ◀◀

@PROCESS:

@PROCESS ONETRIP | NOONETRIP

Defaults

The default is to follow the behavior of later Fortran standards, where **DO** loops are not performed if the iteration count is 0.

Restrictions

It has no effect on **FORALL** statements, **FORALL** constructs, or array constructor implied-**DO** loops.

-B

Category

Compiler customization

@PROCESS

None.

Purpose

Specifies substitute path names for XL Fortran components such as the assembler, C preprocessor, and linker.

It can be used in combination with the `-t` option, which determines which of these components are affected by `-B`. However, it is preferred that you use the `-qpath` option to accomplish this instead.

Syntax

► — -B — prefix —►

Defaults

The default paths for the compiler components are defined in the compiler configuration file.

Parameters

prefix

The name of a directory where the components reside. It must end in a / (slash).

Usage

To form the complete path name for each component, the driver program adds *prefix* to the standard program names. You can restrict the components that are affected by this option by also including one or more *-t mnemonic* options.

You can also specify default path names for these commands in the configuration file.

This option allows you to keep multiple levels of some or all of the XL Fortran components or to try out an upgraded component before installing it permanently. When keeping multiple levels of XL Fortran available, you might want to put the appropriate *-B* and *-t* options into a configuration-file stanza and to use the *-F* option to select the stanza to use.

Related information

- “-qpath” on page 201
- “-t” on page 279
- “-F” on page 75
- “Using custom compiler configuration files” on page 10
- “Running two levels of XL Fortran” on page 18

-C

Category

Error checking and debugging

Purpose

Generates code that performs certain types of runtime checking.

-qcheck is the long form of *-C*.

Syntax

Option:

▶▶ -C —————▶▶

@PROCESS:

@PROCESS CHECK | NOCHECK

Defaults

-qnocheck

-C

Category

Object code control

@PROCESS

None.

Purpose

Instructs the compiler to compile or assemble the source files only but do not link. With this option, the output is a .o file for each source file.

Syntax

▶▶ -c —————▶▶

Defaults

Not applicable.

Usage

Using the **-o** option in combination with **-c** selects a different name for the **.o** file. In this case, you can only compile one source file at a time.

Related information

- “-o” on page 89.
-

-D

Category

Input control

Purpose

Specifies whether the compiler compiles fixed source form lines with a D in column 1 or treats them as comments.

-qdlines is the long form of **-D**.

Syntax

►► -D ◀◀

@PROCESS:

@PROCESS D LINES | NODLINES

Usage

If you specify **-D**, fixed source form lines that have a **D** in column 1 are compiled. The default action is to treat these lines as comment lines. They are typically used for sections of debugging code that need to be turned on and off.

Note that in order to pass C-style **-D** macro definitions to the C preprocessor, for example, when compiling a file that ends with **.F**, use the **-W** option. For example:
-WF, -DDEFINE_THIS

-d

Category

Output control

@PROCESS

None.

Purpose

Causes preprocessed source files that are produced by **cpp** to be kept rather than deleted.

Syntax

►► -d ◀◀

Defaults

Not applicable.

Results

The files that this option produces have names of the form **Ffilename.f***, derived from the names of the original source files. For example, source file **test.F03** is preprocessed into a file called **Ftest.f03**.

Related information

- “Passing Fortran files through the C preprocessor” on page 32

-e

Category

Linking

@PROCESS

None.

Purpose

When used together with the **-qmkshrobj** option, specifies an entry point for a shared object.

Syntax

► — **-e** *entry_name* —►

Defaults

None.

Parameters

name

The name of the entry point for the shared executable.

Usage

Specify the **-e** option only with the **-qmkshrobj** option.

Note: When you link object files, do not use the **-e** option. The default entry point of the executable output is `__start`. Changing this label with the **-e** flag can produce errors.

Related information

- “-qmkshrobj” on page 192

-F

Category

Compiler customization

@PROCESS

None.

Purpose

Specifies an alternative configuration file, which stanza to use within the configuration file, or both.

The configuration file specifies different kinds of defaults, such as options for particular compilation steps and the locations of various files that the compiler requires.

Syntax

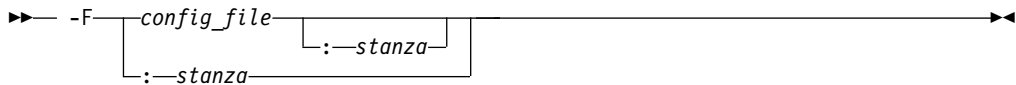

Defaults

By default, the compiler uses the configuration file that is configured at installation time, and the stanza defined in that file for the invocation command currently being used (for example, `xlf2003`, `xlf90_r`, `xlf90`, and so on.).

Parameters

config_file

The full path name of the alternate compiler configuration file to use.

stanza

The name of the configuration file stanza to use for compilation. This directs the compiler to use the entries under that *stanza* regardless of the invocation command being used. For example, if you are compiling with `xlf2003`, but you specify the `xlf95` stanza, the compiler will use all the settings specified in the `xlf95` stanza.

Usage

A simple way to customize the way the compiler works, as an alternative to writing complicated compilation scripts, is to add new stanzas to `/opt/ibm/xlf/15.1.5/etc/xlf.cfg`, giving each stanza a different name and a different set of default compiler options. Or, you can specify a user-defined configuration file with the `XL_F_USR_CONFIG` environment variable rather than editing the default configuration file. You may find a single, centralized file easier to maintain than many scattered compilation scripts and makefiles.

By running the compiler with an appropriate `-F` option, you can select the set of options that you want. You might have one set for full optimization, another set for full error checking, and so on. Note that the settings in any user-defined configuration file are processed before the ones specified by the `-F` option.

Restrictions

Because the default configuration file is replaced each time a new compiler release is installed, make sure to save a copy of any new stanzas or compiler options that you add.

Alternatively, you can store customized settings in the user-defined configuration file specified by the `XL_F_USR_CONFIG` environment variable. This file will not be replaced during reinstallation.

Examples

```
# Use stanza debug in default xlf.cfg.  
xlf95 -F:debug t.f  
  
# Use stanza xlf95 in /home/fred/xlf.cfg.
```

```
xlf95 -F/home/fred/xlf.cfg t.f
# Use stanza myxlf in /home/fred/xlf.cfg.
xlf95 -F/home/fred/xlf.cfg:myxlf t.f
```

Related information

- “Creating custom configuration files” on page 10 explains the contents of a custom, user-defined configuration file and shows how to select different stanzas in the file without using the **-F** option.
- “Editing the default configuration file” on page 14 explains how to edit the contents of a configuration file for use with the **-F** option.
- “-B” on page 71
- “-t” on page 279
- “-W, -X” on page 283

-g

Category

Error checking and debugging

@PROCESS

DBG

Purpose

Generates debugging information for use by a symbolic debugger, and makes the program state available to the debugging session at selected source locations.

You can use different **-g** levels to balance between debug capability and compiler optimization. Higher **-g** levels provide a more complete debug support, at the cost of runtime or possible compile-time performance, while lower **-g** levels provide higher runtime performance, at the cost of some capability in the debugging session.

When the **-O2** optimization level is in effect, the debug capability is completely supported.

When an optimization level higher than **-O2** is in effect, the debug capability is limited.

-g is the short form of **-qdbg**.

Syntax



@PROCESS:

@PROCESS DBG | NODBG

Defaults

If `-g` is not specified, `-g0`, equivalent to `-qnodbg` takes effect, which means that the compiler does not generate any debug information or preserve program state.

If `-g` is specified, the default value is as follows:

- When no optimization is enabled (`-qnoopt`), `-g` is equivalent to `-g9` or `-qdbg=level=9`.
- When the `-O2` optimization level is in effect, `-g` is equivalent to `-g2` or `-qdbg=level=2`.

Parameters

`-g0` Generates no debugging information. No program state is preserved.

`-g1` Generates minimal read-only debugging information about line numbers and source file names. No program state is preserved. This option is equivalent to `-qlinedebug`.

`-g2` Generates read-only debugging information about line numbers, source file names, and variables.

When the `-O2` or higher optimization level is in effect, no program state is preserved.

`-g3, -g4`

Generates read-only debugging information about line numbers, source file names, and variables.

When the `-O2` optimization level is in effect:

- No program state is preserved.
- Procedure parameter values are available to the debugger at the beginning of each procedure.

`-g5, -g6, -g7`

Generates read-only debugging information about line numbers, source file names, and variables.

When the `-O2` optimization level is in effect:

- Program state is available to the debugger at **IF** constructs, loop constructs, procedure definitions, and procedure calls. For details, see “Usage.”
 - Procedure parameter values are available to the debugger at the beginning of each procedure.
- g8** Generates read-only debugging information about line numbers, source file names, and variables.
- When the **-O2** optimization level is in effect:
- Program state is available to the debugger at the beginning of every executable statement.
 - Procedure parameter values are available to the debugger at the beginning of each procedure.
- g9** Generates debugging information about line numbers, source file names, and variables. You can modify the value of the variables in the debugger.
- When the **-O2** optimization level is in effect:
- Program state is available to the debugger at the beginning of every executable statement.
 - Procedure parameter values are available to the debugger at the beginning of each procedure.

Usage

When no optimization is enabled, the debugging information is always available if you specify **-g2** or a higher level. When the **-O2** optimization level is in effect, the debugging information is available at selected source locations if you specify **-g5** or a higher level.

When you specify **-g8** or **-g9** with **-O2**, the debugging information is available at every source line with an executable statement.

When you specify **-g5**, **-g6**, or **-g7** with **-O2**, the debugging information is available for the following language constructs:

- **IF** constructs

The debugging information is available at the beginning of every **IF** statement, namely at the line where the **IF** keyword is specified. It is also available at the beginning of the next executable statement right after the **IF** construct.

- Loop constructs

The debugging information is available at the beginning of every **DO** statement, namely at the line where the **DO** keyword is specified. It is also available at the beginning of the next executable statement right after the **DO** construct.

- Procedure definitions

The debugging information is available at the first executable statement in the body of the procedure.

- Procedure calls

The debugging information is available at the beginning of every statement where a user-defined procedure is called. It is also available at the beginning of the next executable statement right after the statement that contains the procedure call.

Examples

Use the following command to compile `myprogram.f` and generate an executable program called `testing` for debugging:

```
xlf myprogram.f -o testing -g
```

The following command uses a specific `-g` level with `-O2` to compile `myprogram.f` and generate debugging information:

```
xlf myprogram.f -O2 -g8
```

The following command uses a specific `-g` level with `-O2` to compile `myprogram.f` and generate debugging information:

```
xlf myprogram.f -O2 -g8
```

Related information

- SNAPSHOT
- “Debugging a Fortran program” on page 306
- “Symbolic debugger support” on page 6
- “-qdbg” on page 117
- “-qlinedebug” on page 179
- “-qfullpath” on page 141
- “-O” on page 87
- “-qkeepparm” on page 174

-I

Category

Input control

@PROCESS

None.

Purpose

Adds a directory to the search path for include files, `.mod` files, and `.smod` files.

Syntax

►— `-I`—*path_name*—►

Defaults

Not applicable.

Parameters

path_name

A valid path name (for example, `/home/dir`, `/tmp`, or `./subdir`).

Usage

If XL Fortran calls **cpp**, this option adds a directory to the search path for **#include** files. Before checking the default directories for include, .mod, and .smod files, the compiler checks each directory in the search path. For include files, this path is only used if the file name in an **INCLUDE** line is not provided with an absolute path. For **#include** files, refer to the **cpp** documentation for the details of the **-I** option.

Rules

The compiler appends a */* to *path_name* and then concatenates that with the file name before making a search. If you specify more than one **-I** option on the command line, files are searched in the order of the *path_name* names as they appear on the command line.

The following directories are searched, in this order, after any paths that are specified by **-I** options:

1. The current directory (from which the compiler is executed)
2. The directory where the source file is (if different from 1.)
3. */usr/include*

Also, the compiler searches */opt/ibm/xlf/15.1.5/include* where include and .mod files supplied with the compiler are located.

Related information

- “-qmoddir” on page 193
- “-qfullpath” on page 141

-k

Category

Input control

Purpose

Indicates that the source code is in free source form.

This option is the short form of **-qfree=f90**.

Syntax

Option:

▶▶ -k ◀◀

@PROCESS:

@PROCESS FREE(F90)

Related information

- “-qfree” on page 140
- *Free source form* in the *XL Fortran Language Reference*

-L

Category

Linking

@PROCESS

None.

Purpose

At link time, searches the directory path for library files specified by the **-l** option.

Syntax

Option:

►► **-L***Directory*—————►►

Defaults

Not applicable.

Usage

Adds *Directory* to the list of search directories that are used for finding libraries designated by the **-l** flag (lowercase letter **L**). If you use libraries other than the default ones specified in `/opt/ibm/xlf/15.1.5/lib`, you can specify one or more **-L** options that point to the locations of the other libraries.

Rules

This option is passed directly to the **ld** command and is not processed by XL Fortran at all.

Related information

- “Linking” on page 65
- “Linking XL Fortran programs” on page 34

-l

Category

Linking

@PROCESS

None.

Purpose

Searches for the specified library file. The linker searches for *libkey.so*, and then *libkey.a* if *libkey.so* is not found.

Syntax

►► -l *key* ◀◀

Defaults

The compiler default is to search only for some of the compiler runtime libraries. The default configuration file specifies the default library names to search for with the `-l` compiler option, and the default search path for libraries with the `-L` compiler option.

Parameters

key

The name of the library minus the `lib` and `.a` or `.so` characters.

Rules

This option is passed directly to the `ld` command and is not processed by XL Fortran at all.

Examples

To compile `myprogram.f` and link it with library `libmylibrary.so` or `libmylibrary.a` that is found in the `/usr/mylibdir` directory, enter the following command. Preference is given to `libmylibrary.so` over `libmylibrary.a`.

```
xlc myprogram.f -lmylibrary -L/usr/mylibdir
```

Related information

- “Linking” on page 65
- “Linking XL Fortran programs” on page 34

-MF

Category

Output control

@PROCESS

None.

Purpose

Specifies the name or location for the dependency output files that are generated by the `-qmakedep` or `-MMD` option.

For more information about the `-qmakedep` and `-MMD` options, see “`-qmakedep`” on page 185 and “`-MMD`” on page 84.

Syntax

►► -MF *file_path* ◀◀

Defaults

If **-MF** is not specified, the dependency output file is generated in the current working directory. The file has the same base name as the object file, but with a `.d` suffix.

Parameters

file_path

The name or location of the generated dependency output file. *file_path* can be the path name of a file or a directory. It can be relative or absolute.

If *file_path* is the name of an existing directory, the generated dependency output file is placed in the specified directory. It will have the same base name as the generated object file, but with a `.d` suffix. Otherwise, *file_path* is the name of the generated dependency output file. For more information, see the Examples section.

Usage

If the file specified by **-MF** option already exists, it will be overwritten.

If you specify a single file name for the **-MF** option when you compile multiple source files, only a single dependency file will be generated. The dependency file contains the **make** rule for the last file specified on the command line.

Examples

To compile `source.f` and create a dependency output file named `mysource.d`, enter:

```
xlf -c -qmakedep source.f -MF mysource.d
```

To compile `source1.f` and `source2.f` and create two dependency output files, named `source1.d` and `source2.d`, respectively, in the `/project/deps/` directory, enter:

```
xlf -c -qmakedep source1.f source2.f -MF /project/deps/
```

To compile `source.f` and create a dependency output file named `mysource.d` in the `deps/` directory, enter:

```
xlf -c -qmakedep source.f -MF deps/mysource.d
```

To compile `source.f` and create an object file named `object.o` and a dependency output file named `mysource.d`, enter:

```
xlf -c -qmakedep source.f -o object.o -MF mysource.d
```

Related information

- “-qmakedep” on page 185
- “-MMD”
- “-MT” on page 85

-MMD

Category

Output control

@PROCESS

None.

Purpose

Produces a dependency output file containing targets suitable for inclusion in a description file for the **make** command.

The dependency output file is named with a `.d` suffix and specifies a separate rule for each of the main source file's dependencies.

-MMD is the short form of “**-qmakedep**” on page 185.

Syntax

▶▶ **-MMD** ◀◀

Defaults

Not applicable.

Related information

- “**-qmakedep**” on page 185

-MT

Category

Output control

@PROCESS

None.

Purpose

Specifies the target name of the object file in the **make** rule in the dependency output file that is generated by the **-qmakedep** or **-MMD** option.

For more information about the **-qmakedep** and **-MMD** options, see “**-qmakedep**” on page 185 and “**-MMD**” on page 84.

Syntax

▶▶ **-MT** *target* ◀◀

Defaults

If **-MT** is not specified, the target name is the base name of the object file.

Parameters

target The name that you specify for the object file in the generated dependency file.

Usage

Only one target is accepted. If you specify multiple **-MT** options, the target from the last **-MT** option is used.

Examples

A source file named `mysource.f` contains the following code:

```
#include "options.h"
MODULE m
  USE n

CONTAINS
  SUBROUTINE sub
    IMPLICIT NONE
    INCLUDE 'constants.h'
    CALL my_print(pi)
  END SUBROUTINE
END MODULE
```

To compile `mysource.f` and create a dependency output file named `mysource.d`, and also to include path information `/home/user/sample/` as part of the target name of the object file in the `mysource.d` file, enter:

```
xlf -c -qmakedep mysource.f -MT '/home/user/sample/mysource.o'
```

The generated `mysource.d` file is as follows:

```
/home/user/sample/mysource.o m.mod: n.mod
/home/user/sample/mysource.o m.mod: option.h
/home/user/sample/mysource.o m.mod: mysource.f
/home/user/sample/mysource.o m.mod: constants.h
```

Related information

- “-qmakedep” on page 185
- “-MMD” on page 84
- “-MF” on page 83

-NS

Category

Compiler customization

Purpose

Specifies the size (in bytes) of the register spill space; the internal program storage areas used by the optimizer for register spills to storage.

-qspillsize is the long form of **-NS**.

Syntax

Option:

►► -NS-*bytes*—————►►

@PROCESS:

@PROCESS SPILLSIZE(*bytes*)

Defaults

By default, each subprogram stack has 512 bytes of spill space reserved.

If you need this option, a compile-time message informs you of the fact.

Parameters

bytes

The number of bytes of stack space to reserve in each subprogram, in case there are too many variables to hold in registers and the program needs temporary storage for register contents.

Related information

- “-qspillsize” on page 237

-O

Category

Optimization and tuning

Purpose

Specifies whether to optimize code during compilation and, if so, at which level.

-qOPTimize is the long form of -O.

Syntax

Option:

►► -O

0
1
2
3
4
5
fast

—————►►

@PROCESS:

@PROCESS OPTimize[(0|2|3)] | NOOPTimize

Defaults

nooptimize or **-O0** or **optimize=0**

Parameters

not specified

Almost all optimizations are disabled. This is equivalent to specifying **-O0** or **-qnoopt**.

- O** For each release of XL Fortran, **-O** enables the level of optimization that represents the best tradeoff between compilation speed and runtime performance. If you need a specific level of optimization, specify the appropriate numeric value. **-O** is equivalent to **-O2**.
- O0** Almost all optimizations are disabled. This option is equivalent to **-qnoopt**.
- O1** Reserved for future use. This form is ignored and has no effect on the outcome of the compilation.
- O2** Performs a set of optimizations that are intended to offer improved performance without an unreasonable increase in time or storage that is required for compilation.
- O3 | -Ofast** Performs additional optimizations that are memory intensive, compile-time intensive, and may change the semantics of the program slightly, unless **-qstrict** is specified. We recommend these optimizations when the desire for runtime speed improvements outweighs the concern for limiting compile-time resources.

This level of optimization also affects the setting of the **-qfloat** option, turning on the **rsqrt** suboption by default, and sets **-qmaxmem=-1**.

Specifying **-O3** or **-Ofast** implies **-qhot**.

- O4** Aggressively optimizes the source program, trading off additional compile time for potential improvements in the generated code. You can specify the option at compile time or at link time. If you specify it at link time, it will have no effect unless you also specify it at compile time for at least the file that contains the main program.

-O4 implies the following other options:

- **-qipa**
- **-O3** (and all the options and settings that it implies)
- **-qarch=auto**
- **-qtune=auto**
- **-qcache=auto**

Note that the **auto** setting of **-qarch**, **-qtune**, and **-qcache** implies that the execution environment will be the same as the compilation environment.

This option follows the "last option wins" conflict resolution rule, so any of the options that are modified by **-O4** can be subsequently changed.

- O5** Provides all of the functionality of the **-O4** option, but also provides the functionality of the **-qipa=level=2** option.

Note:

To obtain the same floating-point accuracy for optimized and non-optimized applications, you must specify the **-qfloat=nomaf** compiler option. In cases where differences in floating-point accuracy still occur after specifying **-qfloat=nomaf**, the **-qstrict** compiler option allows you to exert greater control over changes that optimization can cause in floating-point semantics.

Usage

Generally, use the same optimization level for both the compile and link steps. This is important when using either the **-O4** or **-O5** optimization level to get the best runtime performance. For the **-O5** level, all loop transformations (as specified via the **-qhot** option) are done at the link step.

Increasing the level of optimization may or may not result in additional performance improvements, depending on whether the additional analysis detects any further optimization opportunities.

An optimization level of **-O3** or higher can change the behavior of the program and potentially cause exceptions that would not otherwise occur. Use of the **-qstrict** option maintains the same program behavior as with **-O2**, at the cost of optimization opportunity. Refer to the **-qstrict** option for the list of optimizations it disables.

When you use **-O** or higher optimization, **-qtbtable=small** is in effect. The traceback table generated has no function name or parameter information.

If the **-O** option is used in an **@PROCESS** statement, only an optimization level of 0, 2, or 3 is allowed. Note that unlike using **-O3** in command line invocation, specifying **@PROCESS OPT(3)** does not imply **-qhot**. If optimization level **-O3** or higher is specified on the command line, the **-qhot** and **-qipa** options that are set by the optimization level cannot be overridden by **@PROCESS OPT(0)** or **@PROCESS OPT(2)**.

Compilations with optimization may require more time and machine resources than other compilations.

The more the compiler optimizes a program, the more difficult it is to debug the program with a symbolic debugger.

Related information

- “-qtbtable” on page 252 controls the amount of debugging traceback information that is included in the object files.
- “-qstrict” on page 242 shows how to turn off the effects of **-O3** that might change the semantics of a program.
- “-qipa” on page 169, “-qpdf1, -qpdf2” on page 202, and “-qhot” on page 149 turn on additional optimizations that may improve performance for some programs.
- “Optimizing your applications” in the *XL Fortran Optimization and Programming Guide* discusses technical details of the optimization techniques the compiler uses and some strategies you can use to get maximum performance from your code.

-O

Category

Output control

@PROCESS

None.

Purpose

Specifies a name for the output object, assembler, or executable file.

Syntax

►► — `-o` *name* —————►►

Defaults

The default name for an executable file is **a.out**. The default name for an object or assembler source file is the same as the source file except that it has a **.o** or **.s** extension.

Usage

To choose the name for an object file, use this option in combination with the **-c** option. For an assembler source file, use it in combination with the **-S** option.

Rules

Except when you specify the **-c** or **-S** option, the **-o** option is passed directly to the **ld** command, instead of being processed by XL Fortran.

Examples

```
xlf95 t.f                # Produces "a.out"
xlf95 -c t.f            # Produces "t.o"
xlf95 -o test_program t.f # Produces "test_program"
xlf95 -S -o t2.s t.f    # Produces "t2.s"
```

-p

Category

Optimization and tuning

@PROCESS

None.

Purpose

Prepares the object files produced by the compiler for profiling.

The compiler produces monitoring code that counts the number of times each routine is called. The compiler inserts a call to the monitor subroutine at the start of each subprogram.

Syntax

►► — `-p` —————►►
 └─ `g` ─┘

Defaults

Not applicable.

Usage

When you run a program compiled with **-p** or **-pg** and it ends normally, it produces a **gmon.out** file with the profiling information. You can then use the **gprof** command to generate a runtime profile.

Examples

```
$ xlf95 -pg needs_tuning.f
$ a.out
$ gprof
```

.
.
.

detailed and verbose profiling data

.
.
.

Related information

- Refer to your operating system documentation for more information on profiling and the **gprof** command.

-qalias

Category

Optimization and tuning

Purpose

Indicates whether a program contains certain categories of aliasing or does not conform to Fortran standard aliasing rules. The compiler limits the scope of some optimizations when there is a possibility that different names are aliases for the same storage location.

Syntax

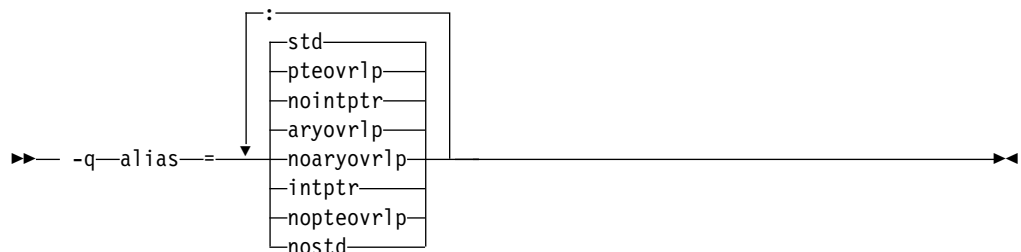

@PROCESS:

```
@PROCESS ALIAS( {ARGUMENT_LIST} )
```

Defaults

`-qalias=aryovrlp:nointptr:pteovrlp:std`

Parameters

aryovrlp | **noaryovrlp**

Indicates whether the compilation units contain any array assignments between storage-associated arrays. If not, specify **noaryovrlp** to improve performance.

intptr | **nointptr**

Indicates whether the compilation units contain any integer **POINTER** statements. If so, specify **intptr**.

pteovrlp | **nopteovrlp**

Indicates whether any pointee variables may be used to refer to any data objects that are not pointee variables, or whether two pointee variables may be used to refer to the same storage location. If not, specify **nopteovrlp**.

std | **nostd**

Indicates whether the compilation units contain any nonstandard aliasing (which is explained below). If so, specify **nostd**.

Usage

An alias exists when an item in storage can be referred to by more than one name. The Fortran 90, Fortran 95, Fortran 2003, and Fortran 2008 standards allow some types of aliasing and disallow some others. The sophisticated optimizations that the XL Fortran compiler performs increase the likelihood of undesirable results when nonstandard aliasing is present, as in the following situations:

- The same data object is passed as an actual argument two or more times in the same subprogram reference. The aliasing is not valid if either of the actual arguments becomes defined, undefined, or redefined.
- A subprogram reference associates a dummy argument with an object that is accessible inside the referenced subprogram. The aliasing is not valid if any part of the object associated with the dummy argument becomes defined, undefined, or redefined other than through a reference to the dummy argument.
- A dummy argument becomes defined, undefined, or redefined inside a called subprogram in some other way than through the dummy argument.
- A subscript to an array within a common block exceeds that array's bounds.

Restrictions

Because this option inhibits some optimizations of some variables, using it can lower performance.

Programs that contain nonstandard or integer **POINTER** aliasing may produce incorrect results if you do not compile them with the correct **-qalias** settings. When you use the **xl** or **xl_r** invocation command to compile the `.f`, `.F`, `.f77`, or `.F77` files, or when you use the `f77` or `fort77` invocation command, the compiler assumes that integer **POINTERS** might be present (**-qalias=aryovrlp:pteovrlp:std:intptr**). All the other invocation commands assume that a program contains only standard aliasing (**-qalias=aryovrlp:pteovrlp:std:nointptr**).

Examples

If the following subroutine is compiled with `-qalias=nopteovrlp`, the compiler may be able to generate more efficient code. You can compile this subroutine with `-qalias=nopteovrlp`, because the integer pointers, `ptr1` and `ptr2`, point at dynamically allocated memory only.

```
subroutine sub(arg)
  real arg
  pointer(ptr1, pte1)
  pointer(ptr2, pte2)
  real pte1, pte2

  ptr1 = malloc(%val(4))
  ptr2 = malloc(%val(4))
  pte1 = arg*arg
  pte2 = int(sqrt(arg))
  arg = pte1 + pte2
  call free(%val(ptr1))
  call free(%val(ptr2))
end subroutine
```

If most array assignments in a compilation unit involve arrays that do not overlap but a few assignments do involve storage-associated arrays, you can code the overlapping assignments with an extra step so that the `NOARYOVRLP` suboption is still safe to use.

```
@PROCESS ALIAS(NOARYOVRLP)
! The assertion that no array assignments involve overlapping
! arrays allows the assignment to be done without creating a
! temporary array.
program test
  real(8) a(100)
  integer :: j=1, k=50, m=51, n=100

  a(1:50) = 0.0d0
  a(51:100) = 1.0d0

  ! Timing loop to achieve accurate timing results
  do i = 1, 1000000
    a(j:k) = a(m:n)    ! Here is the array assignment
  end do

  print *, a
end program

! We cannot assert that this unit is free
! of array-assignment aliasing because of the assignments below.
subroutine sub1
  integer a(10), b(10)
  equivalence (a, b(3))
  a = b          ! a and b overlap.
  a = a(10:1:-1) ! The elements of a are reversed.
end subroutine

! When the overlapping assignment is recoded to explicitly use a
! temporary array, the array-assignment aliasing is removed.
! Although ALIAS(NOARYOVRLP) does not speed up this assignment,
! subsequent assignments of non-overlapping arrays in this unit
! are optimized.
@PROCESS ALIAS(NOARYOVRLP)
subroutine sub2
  integer a(10), b(10), t(10)
  equivalence (a, b(3))
  t = b; a = t
  t = a(10:1:-1); a = t
end subroutine
```

When **SUB1** is called, an alias exists between **J** and **K**. **J** and **K** refer to the same item in storage. In Fortran, this aliasing is not permitted if **J** or **K** are updated, and, if it is left undetected, it can have unpredictable results.

```
CALL SUB1(I,I)
...
SUBROUTINE SUB1(J,K)
```

In the following example, the program might store 5 instead of 6 into **J** unless **-qalias=nostd** indicates that an alias might exist.

```
INTEGER BIG(1000)
INTEGER SMALL(10)
COMMON // BIG
EQUIVALENCE(BIG,SMALL)
...
BIG(500) = 5
SMALL (I) = 6 ! Where I has the value 500
J = BIG(500)
```

Related information

- See *Optimizing your applications* in the *XL Fortran Optimization and Programming Guide* for information on aliasing strategies you should consider.

-qalign

Category

Portability and migration

Purpose

Specifies the alignment of data objects in storage, which avoids performance problems with misaligned data.

Format

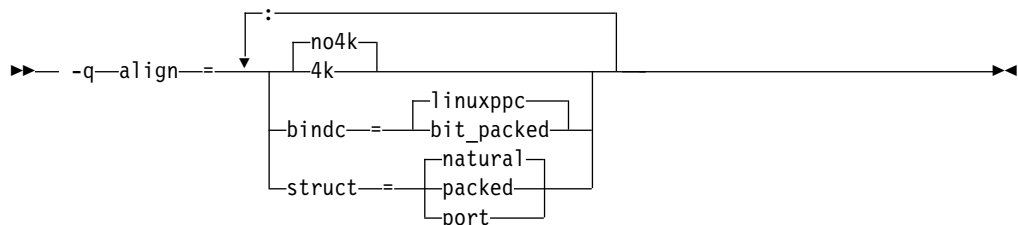

@PROCESS:

```
@PROCESS ALIGN({[NO]4K|STRUCT{(suboption)}|BINDC{(suboption)}})
```

Defaults

-qalign= no4k:struct=natural:bindc=linuxppc.

Parameters

The **[no]4k**, **bindc**, and **struct** options can be specified and are not mutually exclusive. The **[no]4k** option is useful primarily in combination with logical volume I/O and disk striping.

[no]4k

Specifies whether to align large data objects on page (4 KB) boundaries, for improved performance with data-stripped I/O. Objects are affected depending on their representation within the object file. The affected objects are arrays and structures that are 4 KB or larger and are in static or bss storage and also CSECTs (typically **COMMON** blocks) that are 8 KB or larger. A large **COMMON** block, equivalence group containing arrays, or structure is aligned on a page boundary, so the alignment of the arrays depends on their position within the containing object. Inside a structure of non-sequence derived type, the compiler adds padding to align large arrays on page boundaries.

bindc={suboption}

Specifies that the alignment and padding for an XL Fortran derived type with the BIND(C) attribute is compatible with a C struct type that is compiled with the corresponding XL C alignment option. The compatible alignment options include:

XL Fortran Option	Corresponding XL C Option
-qalign=bindc=bit_packed	-qalign=bit_packed
-qalign=bindc=linuxppc	-qalign=linuxppc

struct={suboption}

The struct option specifies how objects or arrays of a derived type declared using a record structure are stored, and whether or not padding is used between components. All program units must be compiled with the same settings of the **-qalign=struct** option. The three suboptions available are:

packed

If the **packed** suboption of the **struct** option is specified, objects of a derived type are stored with no padding between components, other than any padding represented by **%FILL** components. The storage format is the same as would result for a sequence structure whose derived type was declared using a standard derived type declaration.

natural

If the **natural** suboption of the **struct** option is specified, objects of a derived type are stored with sufficient padding such that components will be stored on their natural alignment boundaries, unless storage association requires otherwise. The natural alignment boundaries for objects of a type that appears in the left-hand column of the following table is shown in terms of a multiple of some number of bytes in the corresponding entry in the right-hand column of the table.

Type	Natural Alignment (in multiples of bytes)
INTEGER(1), LOGICAL(1), BYTE, CHARACTER	1
INTEGER(2), LOGICAL(2)	2
INTEGER(4), LOGICAL(4), REAL(4)	4
INTEGER(8), LOGICAL(8), REAL(8), COMPLEX(4)	8
REAL(16), COMPLEX(8), COMPLEX(16)	16

Type	Natural Alignment (in multiples of bytes)
Derived	Maximum alignment of its components

If the **natural** suboption of the **struct** option is specified, arrays of derived type are stored so that each component of each element is stored on its natural alignment boundary, unless storage association requires otherwise.

port

If the **port** suboption of the **struct** option is specified,

- Storage padding is the same as described above for the **natural** suboption, with the exception that the alignment of components of type complex is the same as the alignment of components of type real of the same kind.
- The padding for an object that is immediately followed by a union is inserted at the beginning of the first map component for each map in that union.

Restrictions

The **port** suboption does not affect any arrays or structures with the **AUTOMATIC** attribute or arrays that are allocated dynamically. Because this option may change the layout of non-sequence derived types, when compiling programs that read or write such objects with unformatted files, use the same setting for this option for all source files.

You can tell if an array has the **AUTOMATIC** attribute and is thus unaffected by **-qalign=4k** if you look for the keywords **AUTOMATIC** or **CONTROLLED AUTOMATIC** in the listing of “-qattr” on page 100. This listing also shows the offsets of data objects.

-qaltivec

Category

Language element control

@PROCESS

ALTIVEC(LE | BE)

Purpose

Specifies the order of vector elements in vector registers.

Syntax

```

▶▶ -q—altivec—=le=be

```

Defaults

`-qaltivec=le`

Parameters

- be** Specifies big endian element order. Vectors are laid out in vector registers from left to right, so that element 0 is the leftmost element in the register.
- le** Specifies little endian element order. Vectors are laid out in vector registers from right to left, so that element 0 is the rightmost element in the register.

Usage

The `-qaltivec` option affects the following categories of procedures:

- Vector Multimedia Extension (VMX) load and store intrinsic procedures
- Vector Scalar Extension (VSX) load and store intrinsic procedures
- The nonload and nonstore intrinsic procedures referring to the vector element order

The following list shows all the procedures affected:

- Load procedures
 - VMX load procedures: **VEC_LD**, **VEC_LDE**, and **VEC_LDL**
 - VSX load procedures: **VEC_XLD2**, **VEC_XLW4**, and **VEC_XL**
- Store procedures
 - VMX store procedures: **VEC_ST**, **VEC_STE**, and **VEC_STL**
 - VSX store procedures: **VEC_XSTD2**, **VEC_XSTW4**, and **VEC_XST**
- Nonload and nonstore procedures: **VPERMXOR**, **VEC_EXTRACT**, **VEC_INSERT**, **VEC_MERGEH**, **VEC_MERGEL**, **VEC_MERGEE**, **VEC_MERGE0**, **VEC_MULE**, **VEC_MULO**, **VEC_PACK**, **VEC_PERM**, **VEC_PROMOTE**, **VEC_SPLAT**, **VEC_SUM2S**, **VEC_SUMS**, **VEC_UNPACKH**, and **VEC_UNPACKL**

Examples

- To change the vector element sequence to big endian element order in registers, enter the following command:

```
xlf95 myprogram.f -qaltivec=be
```

Related information

- “-qarch”
- Vector intrinsic procedures (IBM extension)
- Vector data types
- Vector layout in register (big endian or little endian element order)
- “-qsimd” on page 229
- *AltiVec Technology Programming Interface Manual*, available at http://www.freescale.com/files/32bit/doc/ref_manual/ALTIVECPIM.pdf

-qarch

Category

Optimization and tuning

@PROCESS

None.

Purpose

Specifies the processor architecture, or family of architectures, where the code may run. This allows the compiler to take maximum advantage of the machine instructions specific to an architecture, or common to a family of architectures.

Syntax



Defaults

- `-qarch=pwr8`
- `-qarch=auto` when `-O4` or `-O5` is in effect

Parameters

`auto`

Automatically detects the specific architecture of the compiling machine. It assumes that the execution environment will be the same as the compilation environment. This option is implied if the `-O4` or `-O5` option is set or implied.

`pwr8`

Produces object code containing instructions that run on the POWER8 or POWER9 hardware platforms.

`pwr9`

Produces object code containing instructions that run on the POWER9 hardware platforms.

Usage

For any given `-qarch` setting, the compiler defaults to a specific, matching `-qtune` setting, which can provide additional performance improvements. For detailed information about using `-qarch` and `-qtune` together, see “`-qtune`” on page 255.

Examples

To specify that the executable program testing compiled from `myprogram.f` is to run on a computer with VSX instruction support, for example, `power8`, enter:

```
xlf -o testing myprogram.f -qarch=pwr8
```

Related information

- `-qprefetch`
- `-qfloat`
- “`-qtune`” on page 255
- “Compiling for specific architectures” on page 32

-qassert

Category

Optimization and tuning

Purpose

Provides information about the characteristics of your code that can help the compiler fine-tune optimizations.

Syntax

Option:

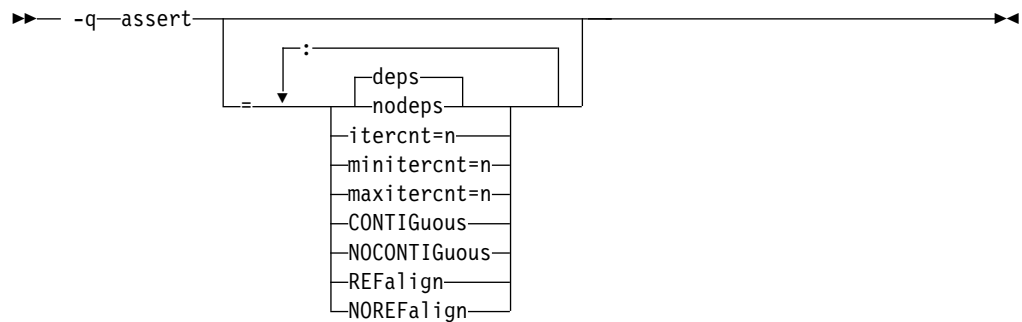

@PROCESS:

@PROCESS ASSERT(suboptions)

Defaults

-qassert=deps:norefalign:nocontig

Parameters

deps | nodeps

Specifies whether or not any loop-carried dependencies exist.

itercnt=*n*

Specifies a value for loop iteration counts for the optimizer to use when it cannot statically determine the loop iteration count. *n* must be a positive integer.

minitercnt=*n*

Specifies the expected minimum iteration count of the loops in the program. *n* must be a positive integer.

maxitercnt=*n*

Specifies the expected maximum iteration count of the loops in the program. *n* must be a positive integer.

CONTIGuous | NOCONTIGuous

Specifies the following contiguity for all compilation units:

- All array pointers are pointer associated with contiguous targets.
- All assumed-shape arrays are argument associated with contiguous actual arguments.

When **-qassert=contig** is specified, the compiler can perform optimizations according to the memory layout of the objects occupying contiguous blocks of memory.

Using **-qassert=contig** does not have the same effect as specifying the **CONTIGUOUS** attribute for array pointers and assumed-shape arrays. **-qassert=contig** does not validate contiguity assertion. F2008 To ensure Fortran 2008 semantics, use the **CONTIGUOUS** attribute. F2008

Notes:

- **-qassert=contig** is not supported through the **ASSERT** directive.
- Using this suboption might produce unexpected results without warning.

REFalign | NOREFalign

Specifies that all pointers inside the compilation unit only point to data that is naturally aligned according to the length of the pointer types. With this assertion, the compiler might generate more efficient code. This assertion is particularly useful when you target a SIMD architecture with **-qhot=level=0** or **-qhot=level=1** with **-qsimd=auto**.

Usage

The **itercnt**, **minitercnt**, and **maxitercnt** values are not required to be accurate. The values only affect performance, never correctness. Specify the values following the rule **minitercnt <= itercnt <= maxitercnt**. Otherwise, messages are issued to indicate that the values are inconsistent and the inconsistent value is ignored.

Related information

- *High-order transformation* in the *XL Fortran Optimization and Programming Guide* for background information and instructions on using these assertions
- The **ASSERT** directive in the *XL Fortran Language Reference*
- F2008 The **CONTIGUOUS** attribute F2008

-qattr

Category

Listings, messages, and compiler information

Purpose

Produces a compiler listing that includes the attribute component of the attribute and cross-reference section of the listing.

Syntax



@PROCESS:

@PROCESS ATTR[(FULL)] | **NOATTR**

Defaults

-qnoattr

Parameters

full

Reports all identifiers in the program, whether they are referenced or not. If you specify **-qattr** without this suboption, reports only those identifiers that are used.

Usage

If you specify **-qattr** after **-qattr=full**, the full attribute listing is still produced.

You can use the attribute listing to help debug problems caused by incorrectly specified attributes or as a reminder of the attributes of each object while writing new code.

Related information

- “Listings, messages, and compiler information” on page 60
- “Attribute and cross reference section” on page 311

-qautodbl

Category

Floating-point and integer control

Purpose

Provides an automatic means of converting single-precision floating-point calculations to double-precision and of converting double-precision calculations to extended-precision.

Syntax

►► -qautodbl=

none
dbl4
dbl8
dbl

►►

@PROCESS:

@PROCESS AUTODBL(*setting*)

Defaults

-qautodbl=none

Parameters

The **-qautodbl** suboptions offer different strategies to preserve storage relationships between objects that are promoted or padded and those that are not.

The settings you can use are as follows:

none Does not promote or pad any objects that share storage. This setting is the default.

dbl4 Promotes floating-point objects that are single-precision (4 bytes in size) or that are composed of such objects (for example, **COMPLEX** or array objects):

- **REAL(4)** is promoted to **REAL(8)**.
- **COMPLEX(4)** is promoted to **COMPLEX(8)**.

This suboption requires the **libxlfpm4.a** library during linking.

dbl8 Promotes floating-point objects that are double-precision (8 bytes in size) or that are composed of such objects:

- **REAL(8)** is promoted to **REAL(16)**.
- **COMPLEX(8)** is promoted to **COMPLEX(16)**.

This suboption requires the **libxlfpm8.a** library during linking.

dbl Combines the promotions that **dbl4** and **dbl8** perform.

This suboption requires the **libxlfpm4.a** and **libxlfpm8.a** libraries during linking.

Usage

You might find this option helpful in porting code where storage relationships are significant and different from the XL Fortran defaults. For example, programs that are written for the IBM VS FORTRAN compiler may rely on that compiler's equivalent option.

If the appropriate **-qautodbl** option is specified during linking, the program is automatically linked with the necessary extra libraries. Otherwise, you must link them in manually.

When you have both **REAL(4)** and **REAL(8)** calculations in the same program and want to speed up the **REAL(4)** operations without slowing down the **REAL(8)** ones, use **dbl4**.

If you want maximum precision of all results, you can use **dbl**. The **dbl4** and **dbl8** suboptions select a subset of real types that have their precision increased.

By using **dbl4**, you can increase the size of **REAL(4)** objects without turning **REAL(8)** objects into **REAL(16)**s. **REAL(16)** is less efficient in calculations than **REAL(8)** is.

The **-qautodbl** option handles calls to intrinsics with arguments that are promoted; when necessary, the correct higher-precision intrinsic function is substituted. For example, if single-precision items are being promoted, a call in your program to **SIN** automatically becomes a call to **DSIN**.

You must not specify the **-qautodbl** option if your program contains vector types.

Restrictions

- Because character data is not promoted or padded, its relationship with storage-associated items that are promoted or padded may not be maintained.
- If the storage space for a pointee is acquired through the system routine **malloc**, the size specified to **malloc** should take into account the extra space needed to represent the pointee if it is promoted or padded.

- If an intrinsic function cannot be promoted because there is no higher-precision specific name, the original intrinsic function is used, and the compiler displays a warning message.
- You must compile every compilation unit in a program with the same **-qautodbl** setting.

Related information

For background information on promotion, padding, and storage/value relationships and for some source examples, see “Implementation details for -qautodbl promotion and padding” on page 316.

“-qrealsize” on page 217 describes another option that works like **-qautodbl**, but it only affects items that are of default kind type and does not do any padding. If you specify both the **-qrealsize** and the **-qautodbl** options, only **-qautodbl** takes effect. Also, **-qautodbl** overrides the **-qdpc** option.

-qbindcextname

Category

Portability and migration

Purpose

Controls whether the **-qextname** option affects **BIND(C)** entities.

Syntax



@PROCESS:

@PROCESS **BINDCEXTNAME** | NOBINDCEXTNAME

Defaults

-qbindcextname

Usage

The **-qextname** option and the **BIND(C)** attribute are two ways of modifying the names of Fortran global entities to facilitate use in C.

If you explicitly specify a **BIND(C)** binding label in an interface block using the **NAME=** specifier, the compiler uses this binding label in calls to the procedure regardless of the **-qextname** and **-qbindcextname** options.

If your interface does not explicitly specify a **BIND(C)** binding label using the **NAME=** specifier, the compiler creates an implicit binding label. If you also specify the **-qextname** option, the compiler appends an underscore to the implicit binding label only when the **-qbindcextname** option is in effect.

If you specify the **-qextname** and **-qbindcextname** options for a compilation unit declaring a **BIND(C)** procedure, the compiler appends an underscore to the binding label, even when the binding label is explicitly specified.

Notes:

- You must ensure that the names of a **BIND(C)** entity are identical. Accordingly, if two compilation units access the same **BIND(C)** entity that does not have an explicitly-specified binding label, you must not compile one unit with the **-qbindcextname** option and the other with the **-qnobindcextname** option.
- The **-q[no]bindcextname** option has effect only if the **-qextname** option is also specified. If the **-qextname** option is specified with a list of named entities, the **-q[no]bindcextname** option only affects these named entities.

Examples

```
interface
  integer function foo() bind(c)
  end funciton
  integer function bar()
  end function
end interface

print *, foo()
print *, bar()
end

xlf90 x.f -qextname -qbindcextname           # calls "foo_", and "bar_"
xlf90 x.f -qextname -qnobindcextname         # calls "foo", and "bar"
xlf90 x.f -qextname=foo -qbindcextname      # calls "foo_", and "bar_"
xlf90 x.f -qextname=foo -qnobindcextname    # calls "foo", and "bar"
xlf90 x.f                                     # calls "foo", and "bar"
xlf90 x.f -qnobindcextname                   # calls "foo", and "bar"
```

Related information

- “-qextname” on page 129
- "BIND (Fortran 2003)"
- "Binding labels"

-qcache

Category

Optimization and tuning

@PROCESS

None.

Purpose

Specifies the cache configuration for a specific execution machine.

The compiler uses this information to tune program performance, especially for loop operations that can be structured (or *blocked*) to process only the amount of data that can fit into the data cache.

Syntax

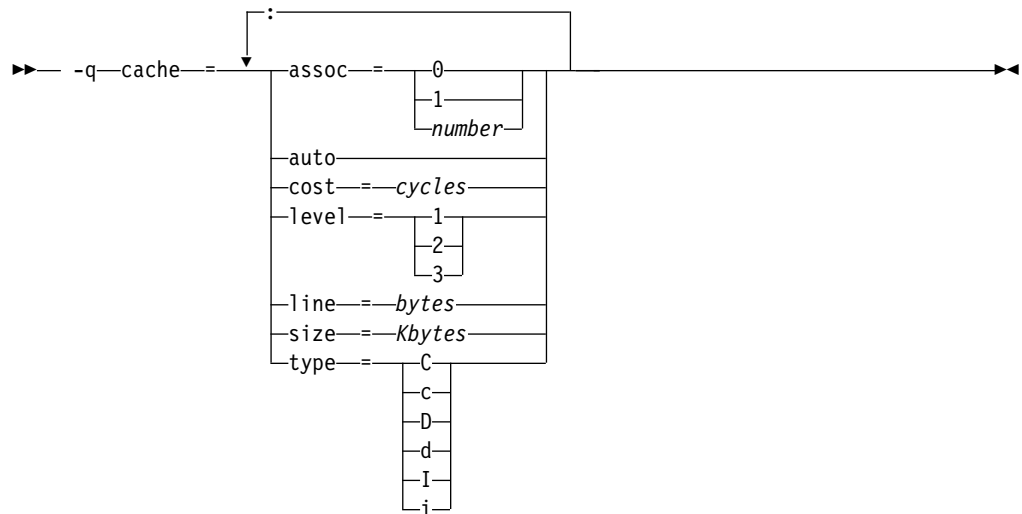

Defaults

Not applicable.

Parameters

assoc=number

Specifies the set associativity of the cache:

- 0** Direct-mapped cache
- 1** Fully associative cache
- n > 1** *n*-way set-associative cache

auto Automatically detects the specific cache configuration of the compiling machine. It assumes that the execution environment will be the same as the compilation environment.

cost=cycles

Specifies the performance penalty that results from a cache miss so that the compiler can decide whether to perform an optimization that might result in extra cache misses.

level=level

Specifies which level of cache is affected:

- 1** Basic cache
- 2** Level-2 cache or the table lookaside buffer (TLB) if the machine has no level-2 cache
- 3** TLB in a machine that does have a level-2 cache

Other levels are possible but are currently undefined. If a system has more than one level of cache, use a separate **-qcache** option to describe each level.

line=bytes

Specifies the line size of the cache.

size=*Kbytes*

Specifies the total size of this cache.

type={C|c|D|d|I|i}

Specifies the type of cache that the settings apply to, as follows:

- **C** or **c** for a combined data and instruction cache
- **D** or **d** for the data cache
- **I** or **i** for the instruction cache

Usage

If you know exactly what type of system a program is intended to be executed on and that system has its instruction or data cache configured differently from the default case (as governed by the **-qtune** setting), you can specify the exact characteristics of the cache to allow the compiler to compute more precisely the benefits of particular cache-related optimizations.

For the **-qcache** option to have any effect, you must include the **level** and **type** suboptions and specify the **-qhot** option or an option that implies **-qhot**.

- If you know some but not all of the values, specify the ones you do know.
- If a system has more than one level of cache, use a separate **-qcache** option to describe each level. If you have limited time to spend experimenting with this option, it is more important to specify the characteristics of the data cache than of the instruction cache.
- If you are not sure of the exact cache sizes of the target systems, use relatively small estimated values. It is better to have some cache memory that is not used than to have cache misses or page faults from specifying a cache that is larger than the target system has.

If you specify the wrong values for the cache configuration or run the program on a machine with a different configuration, the program may not be as fast as possible but will still work correctly. Remember, if you are not sure of the exact values for cache sizes, use a conservative estimate.

Examples

To tune performance for a system with a combined instruction and data level-1 cache where the cache is two-way associative, 8 KB in size, and has 64-byte cache lines:

```
xlf95 -O3 -qhot -qcache=type=c:level=1:size=8:line=64:assoc=2 file.f
```

To tune performance for a system with two levels of data cache, use two **-qcache** options:

```
xlf95 -O3 -qhot -qcache=type=D:level=1:size=256:line=256:assoc=4 \  
-qcache=type=D:level=2:size=512:line=256:assoc=2 file.f
```

To tune performance for a system with two types of cache, again use two **-qcache** options:

```
xlf95 -O3 -qhot -qcache=type=D:level=1:size=256:line=256:assoc=4 \  
-qcache=type=I:level=1:size=512:line=256:assoc=2 file.f
```

Related information

- “-qarch” on page 97
- “-qhot” on page 149
- “-qtune” on page 255

-qcclines

Category

Input control

Purpose

Determines whether the compiler recognizes conditional compilation lines in fixed source form and F90 free source form. This option is not supported with IBM free source form.

Syntax

►► -q cclines
nocclines ◄◄

@PROCESS:

@PROCESS CCLINES | NOCCLINES

Defaults

The default is **-qcclines** if the **-qsmp=omp** option is turned on; otherwise, the default is **-qnocclines**.

Related information

- *Conditional compilation in the XL Fortran Language Reference*

-qcheck

Category

Error checking and debugging

Purpose

Generates code that performs certain types of runtime checking.

-qcheck is the long form of the **-C** option.

Syntax

►► -q nocheck
check all
bounds
nobounds
stacklobber
nostacklobber
unset
nounset ◄◄

@PROCESS:

@PROCESS CHECK[(*suboptions*)] | **NOCHECK**

Defaults

-qnocheck

Parameters

all

Enables all suboptions.

bounds | nobounds

Checks each reference to an array element, array section, or character substring to ensure the reference stays within the defined bounds of the entity.

stacklobber | nostacklobber

Detects stack corruption of nonvolatile registers in the save area in user programs. This type of corruption happens only if any of the nonvolatile registers in the save area of the stack is modified.

If the **-qstackprotect** option and this suboption are both on, this suboption catches the stack corruption first.

unset | nounset

Checks for automatic variables that are used before they are set. A trap will occur at run time if an automatic variable is not set before it is used.

The **-qinitauto** option initializes automatic variables. As a result, the **-qinitauto** option hides uninitialized variables from the **-qcheck=unset** option.

The **-qsave** option changes the storage class of automatic variables to `STATIC`. As a result, the **-qsave** option hides variables that are used before they are set from the **-qcheck=unset** option.

Specify the **-qsigtrap** option to get a traceback that shows the procedure calls leading to the use of the variable. If you also specify the **-g** option, the traceback will include the line numbers and procedure names.

Specifying **-qcheck** with no suboption is equivalent to specifying **-qcheck=all**.

Usage

You can specify the **-qcheck** option more than once. The suboption settings are accumulated, but the later suboptions override the earlier ones.

You can use the **all** suboption along with the **no...** form of one or more of the other options as a filter. For example, the following command provides checking for everything except for references that go out of bounds:

```
xlf myprogram.f -qcheck=all:nobounds
```

If you use **all** with the **no...** form of the suboptions, **all** should usually be the first suboption.

At compile time, if the compiler can determine that a reference goes out of bounds, the severity of the error reported is increased to **S** (severe) when **-qcheck=bounds** is enabled.

At run time, if a reference goes out of bounds or if a certain type of stack corruption is detected, the program generates a **SIGTRAP** signal. By default, this signal ends the program and produces a core dump. This is an expected behavior and does not indicate there is a defect in the compiler product.

Because runtime checking can slow execution, you should decide which is the more important factor for each program: the performance impact or the possibility of incorrect results if an error goes undetected. You might decide to use this option only while testing and debugging a program (if performance is more important) or also for compiling the production version (if safety is more important).

The **-qcheck** option prevents some optimizations. You may want to remove the **-qcheck** option after the debugging of your code is complete and then add any wanted optimization options for better performance.

The valid bounds for character substring expressions differ depending on the setting of the **-qzerosize** option.

Examples

The following code example shows an out-of-bounds access of an allocatable array that is detected by **-qcheck=bounds**:

```
program outofbounds
  real, allocatable :: x(:)
  allocate(x(5:10))
  x(1) = 3.0 ! Out of bound access.
  print *, x
end
```

In the following example, a random assignment of an integer pointer corrupts the save area of the call stack. **-qcheck=stackclobber** detects the problem and causes a trap:

```
subroutine update(i, off, value)
  implicit none
  integer, value :: i, off
  character, value :: value
  integer pointee
  pointer(p, pointee)
  p = i + off
  pointee = ichar(value)
end subroutine

subroutine sub1()
  implicit none
  interface
    subroutine update(i, off, value)
      integer, value :: i, off
      character, value :: value
    end subroutine
  end interface
  character(9) buffer
  buffer = ""
  ! This call to update will corrupt the call stack.
  ! Offset 48 is within the save area for this program.
  call update(loc(buffer), 48, 'a')
  print *, buffer
end subroutine

program main
  call sub1
end program
```

Note: The offset of the save area of the call stack depends on the program source and optimization level. When **-O2** or a lower optimization level is in effect, offset 48 falls within the save area.

In the following function `factorial`, `temp` is not initialized when `n<=1`, and `result` is accessed before it is set when `n>1`. To compile `factorial.f` to detect this issue and causes traps during run time, enter the following command:

```
xlf95 -qcheck=unset -O -g -qsigtrap factorial.f
```

`factorial.f` contains the following code:

```
module m
contains
  recursive function factorial(n) result(result)
    integer, value :: n
    integer result, temp

    if (n > 1) then
      temp = n * factorial(n - 1)
      print *, result ! line 9
    endif

    result = temp ! line 12
  end function
end module

use m
integer x
x = factorial(1)
end
```

The compiler issues the following informational messages and traps occur near line 12 and line 18 during run time:

```
1500-098 (I) "factorial.f", line 9: "result" is used before it is set.
1500-098 (I) "factorial.f", line 12: "temp" might be used before it is set.
1501-510 Compilation successful for file factorial.f.
$ ./a.out
```

```
Signal received: SIGTRAP - Trace trap
Fortran language trap: reference to unset memory location
```

```
Traceback:
  Offset 0x00000014 in procedure __m_NMOD_factorial, near line 12 in file factorial.f
  Offset 0x00000028 in procedure _main, near line 18 in file factorial.f
  --- End of call chain ---
```

Note: If you set `-qcheck=unset` at `noopt`, the compiler does not issue informational messages at compile time.

Related information

- “-qstackprotect” on page 238
- “-qhot” on page 149
- “-qzerosize” on page 277
- “-qsigtrap” on page 228 and *Installing an exception handler* in the *XL Fortran Optimization and Programming Guide* describe how to detect and recover from **SIGTRAP** signals without ending the program.

-qci

Category

Input control

Purpose

Specifies the identification numbers (from 1 to 255) of the **INCLUDE** lines to process.

Syntax



@PROCESS:

@PROCESS CI(*number*,...,*number*)

Defaults

Not applicable.

Usage

This option allows a kind of conditional compilation because you can put code that is only sometimes needed (such as debugging **WRITE** statements, additional error-checking code, or XLF-specific code) into separate files and decide for each compilation whether to process them.

If an **INCLUDE** line has a number at the end, the file is only included if you specify that number in a **-qci** option. The set of identification numbers that is recognized is the union of all identification numbers that are specified on all occurrences of the **-qci** option.

Note:

1. Because the optional number in **INCLUDE** lines is not a widespread XL Fortran feature, using it may restrict the portability of a program.
2. This option works only with the XL Fortran **INCLUDE** directive and not with the **#include** C preprocessor directive.

Examples

```
REAL X /1.0/  
INCLUDE 'print_all_variables.f' 1  
X = 2.5  
INCLUDE 'print_all_variables.f' 1  
INCLUDE 'test_value_of_x.f' 2  
END
```

In this example, compiling without the **-qci** option simply declares **X** and assigns it a value. Compiling with **-qci=1** includes two instances of an include file, and compiling with **-qci=1:2** includes both include files.

Related information

- The **INCLUDE** directive in the *XL Fortran Language Reference*

-qcompact

Category

Optimization and tuning

Purpose

Avoids optimizations that increase code size.

Syntax

►► -q nocompact
compact ◀◀

@PROCESS:

@PROCESS COMPACT | NOCOMPACT

Defaults

-qnocompact

Usage

By default, some techniques the optimizer uses to improve performance, such as loop unrolling and array vectorization, may also make the program larger. For systems with limited storage, you can use **-qcompact** to reduce the expansion that takes place. If your program has many loop and array language constructs, using the **-qcompact** option will affect your application's overall performance. You may want to restrict using this option to those parts of your program where optimization gains will remain unaffected.

Rules

With **-qcompact** in effect, other optimization options still work; the reductions in code size come from limiting code replication that is done automatically during optimization.

This option takes effect only when it is specified at the **-O2** optimization level, or higher.

-qcr

Category

Input control

@PROCESS

None.

Purpose

Controls how the compiler interprets the CR (carriage return) character.

This option allows you to compile code written using a Mac OS or DOS/Windows editor.

Syntax

►► -q nocr
cr ◀◀

Defaults

By default, the CR (Hex value X'0d') or LF (Hex value X'0a') character, or the CRLF (Hex value X'0d0a') combination indicates line termination in a source file.

Usage

If you specify **-qnoctr**, the compiler recognizes only the LF character as a line terminator. You must specify **-qnoctr** if you use the CR character for a purpose other than line termination.

-qctyp1ss

Category

Portability and migration

Purpose

Specifies whether character constant expressions are allowed wherever typeless constants may be used.

This language extension might be needed when you are porting programs from other platforms.

Syntax

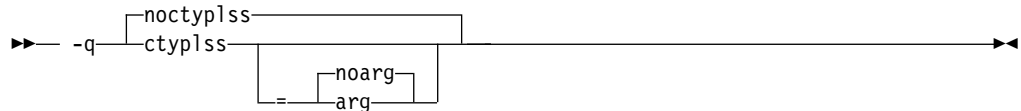

@PROCESS:

@PROCESS CTYPLSS[([NO]ARG)] | NOCTYPLSS

Defaults

-qnoctyp1ss

Parameters

arg | noarg

Suboptions retain the behavior of **-qctyp1ss**. Additionally, **arg** specifies that Hollerith constants used as actual arguments will be treated as integer actual arguments.

Usage

With **-qctyp1ss**, character constant expressions are treated as if they were Hollerith constants and thus can be used in logical and arithmetic expressions.

- If you specify the **-qctyp1ss** option and use a character-constant expression with the **%VAL** argument-list keyword, a distinction is made between Hollerith constants and character constants. Character constants are placed in the

rightmost byte of the register and padded on the left with zeros, while Hollerith constants are placed in the leftmost byte and padded on the right with blanks. All of the other %VAL rules apply.

- The option does not apply to character expressions that involve a constant array or subobject of a constant array at any point.

Examples

Example 1: In the following example, the compiler option `-qctyplss` allows the use of a character constant expression.

```
@PROCESS CTYPLSS
  INTEGER I,J
  INTEGER, PARAMETER :: K(1) = (/97/)
  CHARACTER, PARAMETER :: C(1) = (/A'/)

  I = 4HABCD          ! Hollerith constant
  J = 'ABCD'          ! I and J have the same bit representation

! These calls are to routines in other languages.
  CALL SUB(%VAL('A')) ! Equivalent to CALL SUB(97)
  CALL SUB(%VAL(1HA)) ! Equivalent to CALL SUB(1627389952)

! These statements are not allowed because of the constant-array
! restriction.
!   I = C // C
!   I = C(1)
!   I = CHAR(K(1))
  END
```

Example 2: In the following example, the variable *J* is passed by reference. The suboption `arg` specifies that the Hollerith constant is passed as if it were an integer actual argument.

```
@PROCESS CTYPLSS(ARG)
  INTEGER :: J

  J = 3HIBM
! These calls are to routines in other languages.
  CALL SUB(J)
  CALL SUB(3HIBM) ! The Hollerith constant is passed as if
                  ! it were an integer actual argument
```

Related information

- *Hollerith constants* in the *XL Fortran Language Reference*
- *Passing arguments by reference or by value* in the *XL Fortran Optimization and Programming Guide*

-qcuda (CUDA Fortran)

Category

Language element control

@PROCESS

None.

Purpose

Enables the compiler support for CUDA Fortran.

Syntax

►► -q

cuda
nocuda

 ◄◄

Defaults

- **-qcuda** is the default setting for the **xlcuf** invocation command, and **-qnocuda** is the default setting for other invocation commands.
- When you use **xlf_r** to invoke the compiler, **-qcuda** is the default setting for **.cuf** and **.CUF** files, and **-qnocuda** is the default setting for other file extensions.

Usage

You can specify **-qcuda** only with invocation commands that have the **_r** suffix; these commands ensure threadsafe compilation.

-qcuda can be used with optimization levels **-O2**, **-O3**, and **-Ofast**.

-qcuda can be used with **-qsmp=omp** but not any other suboptions of **-qsmp**. If **-qsmp=omp** is specified, only host code can contain OpenMP parallelization.

-qcuda cannot be used with **-O4**, **-O5**, **-qipa**, **-qpdf1**, **-qpdf2**, or **-qrealsize=8**.

Examples

You can use any of the following commands to compile a CUDA Fortran program:

```
xlf_r mycudaprogram1.cuf
xlf95_r -qcuda mycudaprogram2.f
xlcuf mycudaprogram3.f
xlcuf mycudaprogram4.cuf
```

Related information

- *Getting Started with CUDA Fortran programming using XL Fortran*

-qcudaerr (CUDA Fortran)

Category

Error checking and debugging

Purpose

Controls whether the compiler automatically inserts error checking code for CUDA API calls.

Syntax

Option:

►► -q-cudaerr

stmts
all
none

 ◄◄

@PROCESS:

@PROCESS CUDAERR(STMTS | ALL | NONE)

Defaults

-qcudaerr=stmts

Parameters

stmts Instructs the compiler to insert error checking code for the following items:

- CUDA Runtime API calls that are made in Fortran statements such as ALLOCATE, CALL, and assignment
- Synchronization points such as calls to the cudaDeviceSynchronize API function

all Instructs the compiler to insert error checking code for all CUDA Runtime API calls, including explicit calls in your program.

none Instructs the compiler not to insert error checking code for any CUDA Runtime API call.

Usage

If the inserted error checking code detects a failed CUDA Runtime API call, the compiler issues an error message, which contains the following information:

- The name of the CUDA Runtime API function that failed
- Error code
- Explanation returned by the cudaGetErrorString API function

The inserted error checking code does not clear the detected CUDA errors. The **-qcudaerr** option does not affect user-written error checking code.

To make the compiler exit the program when CUDA Runtime API errors are detected, you can disable runtime error recovery by either of the following ways:

- Call the setrteopts subroutine with err_recovery=no.
- Set the XLFRTEOPTS environment variable as follows:
export XLFRTEOPTS=err_recovery=no

Examples

The example program, `out_of_bounds.cuf`, is as follows.

```
INTEGER, DEVICE, ALLOCATABLE :: device_arr(:)
INTEGER :: host_arr(10)
ALLOCATE(device_arr(5))
device_arr = host_arr
END
```

Compile it with **xlcuf** and run the executable file. The compiler issues the following message:

```
"out_of_bounds.cuf", line 4: 1525-244 API function cudaMemcpy
failed with error code 11: invalid argument.
```

Because `out_of_bounds.cuf` contains assignment between a host array and a nonconformable device array, the assignment is translated into a `cudaMemcpy` API call. However, the API call fails because the CUDA runtime detects that `device_arr`

is too small. Because `-qcudaerr=stmts` is in effect by default, the compiler checks the result of `cudaMemcpy` and displays a message containing the CUDA Runtime API error code and explanation.

Related information

- *Getting Started with CUDA Fortran programming using XL Fortran*

-qdbg

Category

Error checking and debugging

Purpose

`-qdbg` is the long form of `-g`.

Syntax

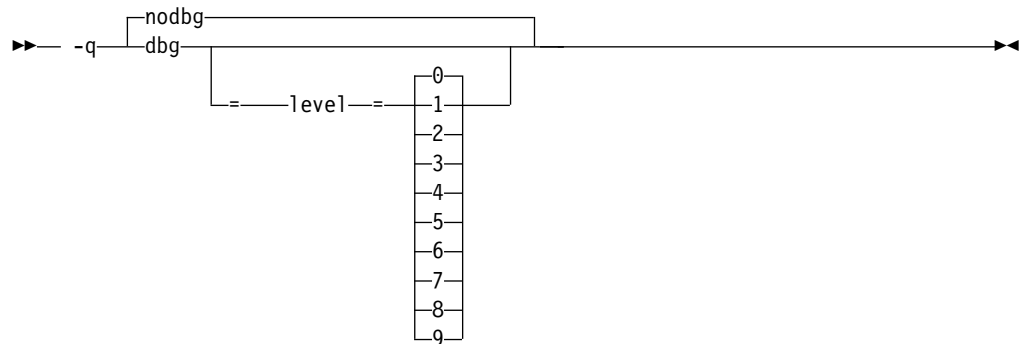

@PROCESS:

@PROCESS DBG | **NODBG**

Defaults

`-qnodbg`, or `-qdbg=level=0`

Parameters

`-qdbg=level=0`

Equivalent to `-qnodbg` or `-g0`.

`-qdbg=level=1`

Equivalent to `-g1` or `-qlinedebug`.

`-qdbg=level=2`

Equivalent to `-g2`.

`-qdbg=level=3`

Equivalent to `-g3`.

`-qdbg=level=4`

Equivalent to `-g4`.

`-qdbg=level=5`

Equivalent to `-g5`.

-qdbg=level=6
Equivalent to **-g6**.

-qdbg=level=7
Equivalent to **-g7**.

-qdbg=level=8
Equivalent to **-g8**.

-qdbg=level=9
Equivalent to **-g9**.

Related information

- “-g” on page 77
- “-qlinedebug” on page 179

-qddim

Category

Portability and migration

Purpose

Specifies that the bounds of pointee arrays are re-evaluated each time the arrays are referenced and removes some restrictions on the bounds expressions for pointee arrays.

Syntax

►► -q noddim
ddim ►►

@PROCESS:

@PROCESS DDIM | NODDIM

Defaults

-qnoddim

Usage

By default, a pointee array can only have dimension declarators containing variable names if the array appears in a subprogram, and any variables in the dimension declarators must be dummy arguments, members of a common block, or use- or host-associated. The size of the dimension is evaluated on entry to the subprogram and remains constant during execution of the subprogram.

With the **-qddim** option:

- The bounds of a pointee array are re-evaluated each time the pointee is referenced. This process is called *dynamic dimensioning*. Because the variables in the declarators are evaluated each time the array is referenced, changing the values of the variables changes the size of the pointee array.
- The restriction on the variables that can appear in the array declarators is lifted, so ordinary local variables can be used in these expressions.

- Pointee arrays in the main program can also have variables in their array declarators.

Examples

```
@PROCESS DDIM
INTEGER PTE, N, ARRAY(10)
POINTER (P, PTE(N))
DO I=1, 10
  ARRAY(I)=I
END DO
N = 5
P = LOC(ARRAY(2))
PRINT *, PTE  ! Print elements 2 through 6.
N = 7        ! Increase the size.
PRINT *, PTE  ! Print elements 2 through 8.
END
```

-qdescriptor

Category

Portability and migration

@PROCESS

None.

Purpose

Specifies the XL Fortran internal descriptor data structure format to use for non object-oriented entities in your compiled applications.

Syntax

►► -q—descriptor—=—v1
v2►►

Defaults

- -qdescriptor=v1

Parameters

v1 Use an internal descriptor data structure format that is compact, but incapable of representing some of the new Fortran language features such as object-orientation.

v2 Use an internal descriptor data structure format that is extensible. This setting allows your programs to take advantage of Fortran's object-oriented features, as well as parameterized derived types.

Usage

Regardless of what **-qdescriptor** setting is in effect, applications containing object-oriented constructs or parameterized derived types will use the **v2** data structure format for those constructs.

The choice of **-qdescriptor** setting is an important consideration when building libraries or modules for distribution. Users of these libraries and modules will need to be aware of the **-qdescriptor** setting and compile the code that uses them in a compatible way. It is suggested that such libraries and modules be built with the **-qsaveopt** option so that the objects themselves will encode the compilation options in a user-readable form.

If you are building modules that contain user-visible derived types, consider building them with the **-qxf2003=polymorphic** suboption. This allows users of the module to use or extend the derived types in a Fortran object-oriented context that uses polymorphism.

In the Fortran 2003 object-oriented programming model, the XL Fortran compiler supports using types and type extensions from types defined in modules not compiled with **-qxf2003=polymorphic**, as long as the types are not used in a context that requires polymorphism. However, if the compiler detects the attempted use of a type or a type extension from a module not compiled with **-qxf2003=polymorphic** in a context that requires polymorphism, an error message will be issued and compilation halted.

If a module built with the **-qdescriptor=v1** setting is used in a compilation where **-qdescriptor=v2** has been specified, the compiler will diagnose this mismatch and halt compilation after issuing an error message.

When using the **-qdescriptor=v2** option, the compiler is unable to diagnose unsafe usage where objects built with the **v2** setting are mixed with those built with the **v1** setting or with XL Fortran 10.1 or older compilers. Even if your program appears to function properly, this usage is unsupported. The descriptor formats are different sizes and, when used with certain constructs, data layouts will change resulting in undefined and unsupported behavior. For example, the sizes of allocatable and pointer entities within derived types will be different resulting a differing size for the derived type itself.

Related information

- “-qsaveopt” on page 224
- “-qxf2003” on page 270

-qdirective

Category

Input control

Purpose

Specifies sequences of characters, known as trigger constants, that identify comment lines as compiler comment directives.

A compiler comment directive is a line that is not a Fortran statement but is recognized and acted on by the compiler.

Format

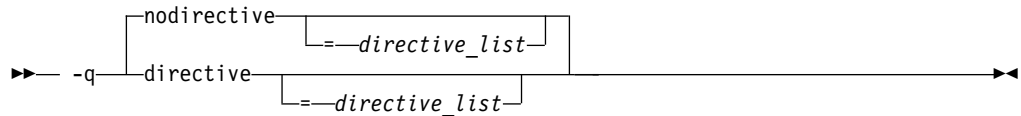

@PROCESS:

@PROCESS DIRECTIVE[(*directive_list*)] | **NODIRECTIVE**[(*directive_list*)]

Defaults

The compiler recognizes the default trigger constant **IBM***.

The **-qsmp** option implies **-qdirective=SMP\\$\:\$OMP:IBMP**, which enables the compiler to also recognize the **SMP**, **\$OMP**, and **IBMP** trigger constants.

The **-qthreaded** option implies **-qdirective=ibmt**, which enables the compiler to also recognize the **IBMT** trigger constant.

Parameters

The **-qnodirective** option with no *directive_list* turns off all previously specified directive identifiers; with a *directive_list*, it turns off only the selected identifiers.

-qdirective with no *directive_list* turns on the default trigger constant **IBM*** if it has been turned off by a previous **-qnodirective**.

Usage

Note the following:

- Multiple **-qdirective** and **-qnodirective** options are additive; that is, you can turn directive identifiers on and off again multiple times.
- One or more *directive_lists* can be applied to a particular file or compilation unit; any comment line beginning with one of the strings in the *directive_list* is then considered to be a compiler comment directive.
- The trigger constants are not case-sensitive.
- The characters (,) , ' , " , : , = , comma, and blank cannot be part of a trigger constant.
- To avoid wildcard expansion in trigger constants that you might use with these options, you can enclose them in single quotation marks on the command line. For example:

```
xlf95 -03 -qhot -qcache=type=D:level=1 -qdirective='dbg*' -qnodirective='IBM*' directives.f
```
- This option only affects Fortran directives that the XL Fortran compiler provides, not those that any preprocessors provide.
- As the use of incorrect trigger constants can generate warning messages, error messages, or both, you should check the particular directive statement for the suitable associated trigger constant.

Examples

```
! This program is written in Fortran free source form.
PROGRAM DIRECTV
INTEGER A, B, C, D, E, F
A = 1 ! Begin in free source form.
B = 2
!OLDSTYLE SOURCEFORM(FIXED)
```

```

! Switch to fixed source form for this include file.
      INCLUDE 'set_c_and_d.inc'
!IBM* SOURCEFORM(FREE)
! Switch back to free source form.
E = 5
F = 6
END

```

For this example, compile with the option **-qdirective=oldstyle** to ensure that the compiler recognizes the **SOURCEFORM** directive before the **INCLUDE** line. After processing the include-file line, the program reverts back to free source form, after the **SOURCEFORM(FREE)** statement.

- The **SOURCEFORM** directive in the *XL Fortran Language Reference*
- The *Directives* section in the *XL Fortran Language Reference*

Related reference:

“-qsmp” on page 232

“-qthreaded” on page 253

-qdirectstorage

Category

Optimization and tuning

@PROCESS

None.

Context

None.

Purpose

Informs the compiler that a given compilation unit may reference write-through-enabled or cache-inhibited storage.

Format

►► -q nodirectstorage directstorage ◄◄

Defaults

-qnodirectstorage

Usage

Use this option with discretion. It is intended for programmers who know how the memory and cache blocks work, and how to tune their applications for optimal performance. For a program to execute correctly on all Power implementations of cache organization, the programmer should assume that separate instruction and data caches exist, and should program to the separate cache model.

Note: Using the `-qdirectstorage` option together with the `CACHE_ZERO` directive may cause your program to fail, or to produce incorrect results.

Related information

- `CACHE_ZERO` in the *XL Fortran Language Reference*.

-qdlines

Category

Input control

Purpose

`-qdlines` is the long form of `-D`.

Format



@PROCESS:

@PROCESS DLINES | NODLINES

Defaults

`-qnodlines`

-qdpc

Category

Floating-point and integer control

Purpose

Increases the precision of real constants for maximum accuracy, when assigning real constants to **DOUBLE PRECISION** variables.

This language extension might be needed when you are porting programs from other platforms.

Format

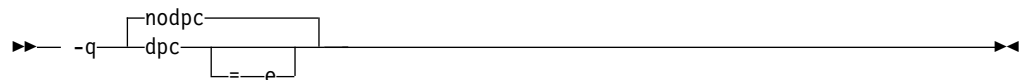

@PROCESS:

@PROCESS DPC[(E)] | NODPC

Defaults

`-qnodpc`

Usage

If you specify **-qdp**, all basic real constants (for example, 1.1) are treated as double-precision constants; the compiler preserves some digits of precision that would otherwise be lost during the assignment to the **DOUBLE PRECISION** variable. If you specify **-qdp=e**, all single-precision constants, including constants with an e exponent, are treated as double-precision constants.

This option does not affect constants with a kind type parameter specified.

-qautodbl and **-qrealsize** are more general-purpose options that can also do what **-qdp** does. **-qdp** has no effect if you specify either of these options.

Examples

```
@process nodpc
  subroutine nodpc
    real x
    double precision y
    data x /1.000000000001/ ! The trailing digit is lost
    data y /1.000000000001/ ! The trailing digit is lost

    print *, x, y, x .eq. y ! So x is considered equal to y
  end

@process dpc
  subroutine dpc
    real x
    double precision y
    data x /1.000000000001/ ! The trailing digit is lost
    data y /1.000000000001/ ! The trailing digit is preserved

    print *, x, y, x .eq. y ! So x and y are considered different
  end

  program testdpc
    call nodpc
    call dpc
  end
```

When compiled, this program prints the following:

```
1.000000000    1.0000000000000000    T
1.000000000    1.0000000000100009    F
```

showing that with **-qdp** the extra precision is preserved.

- “-qautodbl” on page 101
- “-qrealsize” on page 217

-qenum

Category

Floating-point and integer control

@PROCESS

None.

Purpose

Specifies the range of the enumerator constant and enables storage size to be determined.

Syntax



Defaults

`-qenum=4`

Usage

Regardless of its storage size, the enumerator's value will be limited by the range that corresponds to *value*. If the enumerator value exceeds the range specified, a warning message is issued and truncation is performed as necessary.

The range limit and kind type parameter corresponding to each *value* is as follows:

Table 18. Enumerator sizes and types

Value	Valid range of enumerator constant value	Kind type parameter
1	-128 to 127	4
2	-32768 to 32767	4
4	-2147483648 to 2147483647	4
8	-9223372036854775808 to 9223372036854775807	8

Related information

- `ENUM/ENDENUM` statement in the *XL Fortran Language Reference*

-qescape

Category

Portability and migration

Purpose

Specifies how the backslash is treated in character strings, Hollerith constants, H edit descriptors, and character string edit descriptors.

It can be treated as an escape character or as a backslash character. This language extension might be needed when you are porting programs from other platforms.

Syntax

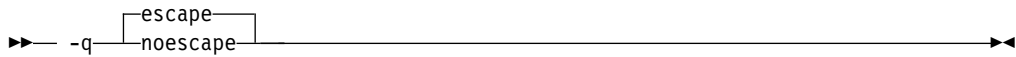

@PROCESS:

@PROCESS **ESCAPE** | NOESCAPE

Defaults

-qescape

Usage

When **-qescape** is specified, the backslash is interpreted as an escape character in these contexts. If you specify **-qnoescape**, the backslash is treated as the backslash character.

The default setting is useful for the following:

- Porting code from another Fortran compiler that uses the backslash as an escape character.
- Including “unusual” characters, such as tabs or newlines, in character data. Without this option, the alternative is to encode the ASCII values (or EBCDIC values, on mainframe systems) directly in the program, making it harder to port.

If you are writing or porting code that depends on backslash characters being passed through unchanged, specify **-qnoescape** so that they do not get any special interpretation. You could also write `\\` to mean a single backslash character under the default setting.

Examples

```
$ # Demonstrate how backslashes can affect the output
$ cat escape.f
      PRINT *, 'a\bcd\fg'
      END
$ xlf95 escape.f
** _main === End of Compilation 1 ===
1501-510  Compilation successful for file escape.f.
$ a.out
cde
  g
$ xlf95 -qnoescape escape.f
** _main === End of Compilation 1 ===
1501-510  Compilation successful for file escape.f.
$ a.out
a\bcd\fg
```

In the first compilation, with the default setting of **-qescape**, `\b` is printed as a backspace, and `\f` is printed as a formfeed character.

With the **-qnoescape** option specified, the backslashes are printed like any other character.

Related information

The list of escape sequences that XL Fortran recognizes is shown in *Escape sequences for character strings* in the *XL Fortran Optimization and Programming Guide*.

-qessl

Category

Optimization and tuning

@PROCESS

None.

Purpose

Allows the compiler to substitute the Engineering and Scientific Subroutine Library (ESSL) routines in place of Fortran 90 intrinsic procedures.

The ESSL is a collection of subroutines that provides a wide range of mathematical functions for various scientific and engineering applications. The subroutines are tuned for performance on specific architectures. Some of the Fortran 90 intrinsic procedures have similar counterparts in ESSL. Performance is improved when these Fortran 90 intrinsic procedures are linked with ESSL. In this case, you can keep the interface of Fortran 90 intrinsic procedures, and get the added benefit of improved performance using ESSL.

Syntax

►► — -q —

noessl
essl

 —————►►

Defaults

-qnoessl

Usage

Use the ESSL Serial Library when linking with **-lessl**. Use the ESSL SMP Library when linking with **-lesslsmpl**.

-lessl or **-lesslsmpl** must be used whenever code is being compiled with **-qessl**.

Also, since **libessl.so** and **libesslsmpl.so** have a dependency on **libxlf90_r.so**, compile with **xlf_r**, **xlf90_r**, or **xlf95_r**, which use **libxlf90_r.so** as the default to link. You can also specify **-lxlf90_r** on the link command line if you use the linker directly, or other commands to link.

The following MATMUL function calls may use ESSL routines when **-qessl** is enabled:

```
real a(10,10), b(10,10), c(10,10)
      c=MATMUL(a,b)
```

Related information

The ESSL libraries are not shipped with the XL Fortran compiler. For more information about these libraries, see the Engineering and Scientific Subroutine Library (ESSL) and Parallel ESSL web page.

-qextern

Category

Portability and migration

@PROCESS

None.

Purpose

Allows user-written procedures to be called instead of XL Fortran intrinsics.

Syntax

► — -qextern=*names* — ◄

Defaults

Not applicable.

Parameters

names

A list of procedure names separated by colons.

Usage

The procedure names are treated as if they appear in an **EXTERNAL** statement in each compilation unit being compiled. If any of your procedure names conflict with XL Fortran intrinsic procedures, use this option to call the procedures in the source code instead of the intrinsic ones.

Because of the many Fortran 90 and Fortran 95 intrinsic functions and subroutines, you might need to use this option even if you did not need it for FORTRAN 77 programs.

Examples

```
subroutine matmul(res, aa, bb, ext)
  implicit none
  integer ext, i, j, k
  real aa(ext, ext), bb(ext, ext), res(ext, ext), temp
  do i = 1, ext
    do j = 1, ext
      temp = 0
      do k = 1, ext
        temp = temp + aa(i, k) * bb(k, j)
      end do
      res(i, j) = temp
    end do
  end do
end subroutine

implicit none
integer i, j, irand
integer, parameter :: ext = 100
real ma(ext, ext), mb(ext, ext), res(ext, ext)
```



```

do i = 1, ext
  do j = 1, ext
    ma(i, j) = float(irand())
    mb(i, j) = float(irand())
  end do
end do

call matmul(res, ma, mb, ext)
end

```

Compiling this program with no options fails because the call to **MATMUL** is actually calling the intrinsic subroutine, not the subroutine defined in the program. Compiling with **-qextern=matmul** allows the program to be compiled and run successfully.

-qextern

Category

Portability and migration

Purpose

Adds an underscore to the names of all global entities.

Syntax



@PROCESS:

@PROCESS EXTNAME[(*name1*, *name2*,...)] | NOEXTNAME

Defaults

-qnoextern

Parameters

name

Identifies a specific global entity (or entities). For a list of named entities, separate each name with a colon. For example: *name1: name2:....*

The name of a main program is not affected.

Usage

The **-qextern** option helps to port mixed-language programs to XL Fortran without modifications.

Use of this option avoids naming problems that might otherwise be caused by:

- Fortran subroutines, functions, or common blocks that are named **main**, **MAIN**, or have the same name as a system subroutine
- Non-Fortran routines that are referenced from Fortran and contain an underscore at the end of the routine name

Note: XL Fortran Service and Utility Procedures , such as `flush_` and `dtime_`, have these underscores in their names already. By compiling with the `-qextname` option, you can code the names of these procedures without the trailing underscores.

- Non-Fortran routines that call Fortran procedures and use underscores at the end of the Fortran names
- Non-Fortran external or global data objects that contain an underscore at the end of the data name and are shared with a Fortran procedure

You must compile all the source files for a program, including the source files of any required module files, with the same `-qextname` setting.

If you use the `xlfortility` module to ensure that the Service and Utility subprograms are correctly declared, you must change the name to `xlfortility_extname` when compiling with `-qextname`.

If there is more than one Service and Utility subprogram referenced in a compilation unit, using `-qextname` with no names specified and the `xlfortility_extname` module may cause the procedure declaration check not to work accurately.

This option also affects the names that are specified in the `-qextern`, `-qinline`, and `-qsigtrap` options. You do not have to include underscores in their names on the command line.

Examples

```
@PROCESS EXTNAME
  SUBROUTINE STORE_DATA
    CALL FLUSH(10) ! Using EXTNAME, we can drop the final underscore.
  END SUBROUTINE

@PROCESS(EXTNAME(sub1))
program main
  external :: sub1, sub2
  call sub1()      ! An underscore is added.
  call sub2()      ! No underscore is added.
end program
```

Related information

- “`-qextern`” on page 128
- “`-qinline`” on page 163
- “`-qsigtrap`” on page 228
- “`-qbindcextname`” on page 103

-qfdpr

Category

Optimization and tuning

@PROCESS

None.

Purpose

Provides object files with information that the IBM Feedback Directed Program Restructuring (FDPR) performance-tuning utility needs to optimize the resulting executable file.

When **-qfdpr** is in effect, optimization data is stored in the object file.

Syntax

►► -q nofdpr
fdpr _____►►

Defaults

-qnofdpr

Usage

For best results, use **-qfdpr** for all object files in a program; FDPR will perform optimizations only on the files compiled with **-qfdpr**, and not library code, even if it is statically linked.

The optimizations that the FDPR utility performs are similar to those that the **-qpdf** option performs.

The FDPR performance-tuning utility has its own set of restrictions, and it is not guaranteed to speed up all programs or produce executables that produce exactly the same results as the original programs.

Examples

To compile `myprogram.f` so it includes data required by the FDPR utility, enter:

```
xlf myprogram.f -qfdpr
```

Related information

- “-qpdf1, -qpdf2” on page 202

-qfixed

Category

Input control

Purpose

Indicates that the input source program is in fixed source form and optionally specifies the maximum line length.

Syntax

►► -q-fixed _=_right_margin_=_ _____►►

@PROCESS:

@PROCESS FIXED[(right_margin)]

Defaults

-qfixed=72 is the default for the `xlf` and `xlf_r` invocation commands when they are used to compile the `.f`, `.F`, `.f77`, or `.F77` files.

-qfixed=72 is also the default for the `f77` and `fort77` invocation commands.

Note:

-qfree=f90 is the default for the `f90`, `xlf90`, `xlf90_r`, `f95`, `xlf95`, `xlf95_r`, `f2003`, `xlf2003`, `xlf2003_r`, `f2008`, `xlf2008`, `xlf2008_r`, and `CUDA Fortran xlcuf` `CUDA Fortran` commands.

Usage

The source form specified when executing the compiler applies to all of the input files, although you can switch the form for a compilation unit by using a **FREE** or **FIXED** @PROCESS directive, or switch the form for the rest of the file by using a **SOURCEFORM** comment directive (even inside a compilation unit).

For source code from some other systems, you may find you need to specify a right margin larger than the default. This option allows a maximum right margin of 132.

Related information

- “-qfree” on page 140
- See *Fixed source form* in the *XL Fortran Language Reference*.

-qflag

Category

Listings, messages, and compiler information

Purpose

Limits the diagnostic messages to those of a specified severity level or higher.

Syntax

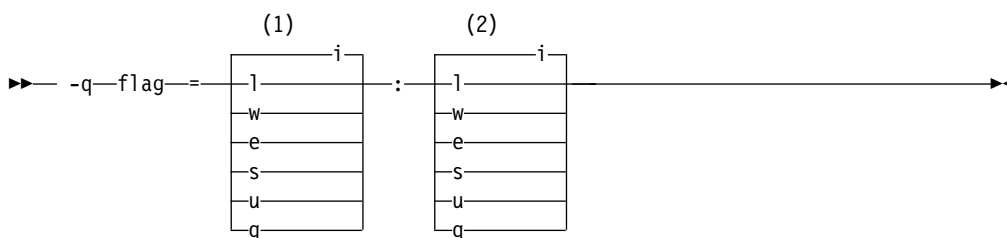

Notes:

- 1 Minimum severity level of messages reported in listing

2 Minimum severity level of messages reported on terminal

@PROCESS:

@PROCESS FLAG(*listing_severity*,*terminal_severity*)

Defaults

-qflag=i:i, which shows all compiler messages.

Parameters

The severity levels (from lowest to highest) are:

- i** Informational messages. They explain things that you should know, but they usually do not require any action on your part.
- l** Language-level messages, such as those produced under the **-qlanglvl** option. They indicate possible nonportable language constructs.
- w** Warning messages. They indicate error conditions that might require action on your part, but the program is still correct.
- e** Error messages. They indicate error conditions that require action on your part to make the program correct, but the resulting program can probably still be executed.
- s** Severe error messages. They indicate error conditions that require action on your part to make the program correct, and the resulting program will fail if it reaches the location of the error. You must change the **-qhalt** setting to make the compiler produce an object file when it encounters this kind of error.
- u** Unrecoverable error messages. They indicate error conditions that prevent the compiler from continuing. They require action on your part before you can compile your program.
- q** No messages. A severity level that can never be generated by any defined error condition. Specifying it prevents the compiler from displaying messages, even if it encounters unrecoverable errors.

Usage

You must specify both *listing_severity* and *terminal_severity*.

Only messages with severity *listing_severity* or higher are written to the listing file. Only messages with severity *terminal_severity* or higher are written to the terminal.

The **-qflag** option overrides any **-qlanglvl** or **-qsaa** options specified.

The **-w** option is a short form for **-qflag=e:e**.

The **-qhaltmsg** option has precedence over the **-qflag** option. If you specify both **-qhaltmsg** and **-qflag**, messages that **-qflag** does not select are also printed and compilation stops.

Note: If **-qflag=u:u** or **-qflag=q:q** is specified, the message specified by **-qhaltmsg** is not shown.

Related information

- “-qhalt” on page 147
- “-qlanglvl” on page 175
- “-qmaxerr” on page 188
- “-qhaltonmsg” on page 148
- “-qsa” on page 222
- “-qsuppress” on page 249
- “-w” on page 282
- “Understanding XL Fortran error messages” on page 299

-qfloat

Category

Floating-point and integer control

Purpose

Selects different strategies for speeding up or improving the accuracy of floating-point calculations.

Syntax



@PROCESS:

@PROCESS FLOAT(*suboptions*)

Defaults

- `-qfloat=nofenv:fold:nogcclongdouble:nohscmplx:nohsflt:maf:nonans:rngchk:norm:norsqrt:nostrictnmaf:nosubnormals`

- `-qfloat=rsqrt:norngchk` when `-qnostrict`, `-qstrict=nooperationprecision:noexceptions`, or the `-O3` or higher optimization level is in effect.

Parameters

`fenv` | `nofenv`

Specifies whether the code depends on the hardware environment and whether to suppress optimizations that could cause unexpected results due to this dependency.

Certain floating-point operations rely on the status of Floating-Point Status and Control Register (FPSCR), for example, to control the rounding mode or to detect underflow. In particular, many compiler built-in functions read values directly from the FPSCR.

When `nofenv` is in effect, the compiler assumes that the program does not depend on the hardware environment, and that aggressive compiler optimizations that change the sequence of floating-point operations are allowed. When `fenv` is in effect, such optimizations are suppressed.

You should use `fenv` for any code containing statements that read or set the hardware floating-point environment, to guard against optimizations that could cause unexpected behavior.

`fold` | `nofold`

Evaluates constant floating-point expressions at compile time, which may yield slightly different results from evaluating them at run time. The compiler always evaluates constant expressions in specification statements, even if you specify `nofold`.

`gcclongdouble` | `nogcclongdouble`

Specifies whether the compiler uses GCC-supplied or IBM-supplied library functions for 128-bit REAL(16) and COMPLEX(32) operations.

`gcclongdouble` ensures binary compatibility with GCC for mathematical calculations. If this compatibility is not important in your application, you should use `nogcclongdouble` for better performance.

Note: Passing results from modules compiled with `nogcclongdouble` to modules compiled with `gcclongdouble` may produce different results for numbers such as Inf, NaN, and other rare cases. To avoid such incompatibilities, the compiler provides built-in functions to convert IBM long double types to GCC long double types.

`hscmplx` | `nohscmplx`

Speeds up operations involving complex division and complex absolute value. This suboption, which provides a subset of the optimizations of the `hsflt` suboption, is preferred for complex calculations.

`hsflt` | `nohsflt`

Speeds up calculations by preventing rounding for single-precision expressions and by replacing floating-point division by multiplication with the reciprocal of the divisor. `hsflt` implies `hscmplx`.

The `hsflt` suboption overrides the `nans` and `spnans` suboptions.

Note: Use `-qfloat=hsflt` on applications that perform complex division and floating-point conversions where floating-point calculations have known characteristics. In particular, all floating-point results must be within the defined range of representation of single precision. Use with discretion, as this

option may produce unexpected results without warning. For complex computations, it is recommended that you use the **hscmplx** suboption (described above), which provides equivalent speed-up without the undesirable results of **hsflt**.

maf | **nomaf**

Makes floating-point calculations faster and more accurate by using floating-point multiply-add instructions where appropriate. The results may not be exactly equivalent to those from similar calculations performed at compile time or on other types of computers. Negative zero results may be produced. Rounding towards negative infinity or positive infinity will be reversed for these operations. This suboption may affect the precision of floating-point intermediate results. If **-qfloat=nomaf** is specified, no multiply-add instructions will be generated unless they are required for correctness.

nans | **nonans**

Allows you to use the **-qflttrap=invalid:enable** option to detect and deal with exception conditions that involve signaling NaN (not-a-number) values. Use this suboption only if your program explicitly creates signaling NaN values, because these values never result from other floating-point operations.

rngchk | **norngchk**

At optimization level **-O3** and above, and without **-qstrict**, controls whether range checking is performed for input arguments for software divide and inlined square root operations. Specifying **norngchk** instructs the compiler to skip range checking, allowing for increased performance where division and square root operations are performed repeatedly within a loop.

Note that with **norngchk** in effect the following restrictions apply:

- The dividend of a division operation must not be +/-INF.
- The divisor of a division operation must not be 0.0, +/- INF, or denormalized values.
- The quotient of dividend and divisor must not be +/-INF.
- The input for a square root operation must not be INF.

If any of these conditions are not met, incorrect results may be produced. For example, if the divisor for a division operation is 0.0 or a denormalized number (absolute value $< 2^{-1022}$ for double precision, and absolute value $< 2^{-126}$ for single precision), NaN, instead of INF, may result; when the divisor is +/-INF, NaN instead of 0.0 may result. If the input is +INF for a sqrt operation, NaN, rather than INF, may result.

norngchk is only allowed when **-qnostrict** is in effect. If **-qstrict**, **-qstrict=infinities**, **-qstrict=operationprecision**, or **-qstrict=exceptions** is in effect, **norngchk** is ignored.

rrm | **norrm**

Prevents floating-point optimizations that require the rounding mode to be the default, round-to-nearest, at run time, by informing the compiler that the floating-point rounding mode may change or is not round-to-nearest at run time. You should use **rrm** if your program changes the runtime rounding mode by any means; otherwise, the program may compute incorrect results.

rsqrt | **norsqrt**

Speeds up some calculations by replacing division by the result of a square root with multiplication by the reciprocal of the square root.

If you compile with the **-O3** or higher optimization level, **rsqrt** is enabled automatically. To disable it, also specify **-qstrict**, **-qstrict=nans**, **-qstrict=infinities**, **-qstrict=zerosigns**, or **-qstrict=exceptions**.

strictnmaf | **nostrictnmaf**

Turns off floating-point transformations that are used to introduce negative MAF instructions, as these transformations do not preserve the sign of a zero value. By default, the compiler enables these types of transformations.

To ensure strict semantics, specify both **-qstrict** and **-qfloat=strictnmaf**.

subnormals | **nosubnormals**

Specifies whether the code uses subnormal floating point values, also known as denormalized floating point values. Whether or not you specify this suboption, the behavior of your program will not change, but the compiler uses this information to gain possible performance improvements.

Note: For details about the relationship between **-qfloat** suboptions and their **-qstrict** counterparts, see “-qstrict” on page 242.

Usage

Using **-qfloat** suboptions other than the default settings might produce incorrect results in floating-point computations if the system does not meet all required conditions for a given suboption. Therefore, use this option only if the floating-point calculations involving IEEE floating-point values are manipulated and can properly assess the possibility of introducing errors in the program.

If the **-qstrict** | **-qnostrict** and **float** suboptions conflict, the last setting specified is used.

Examples

To compile `myprogram.f` so that the constant floating-point expressions are evaluated at compile time and multiply-add instructions are not generated, enter:

```
xlf myprogram.f -qfloat=fold:nomaf
```

Related information

- “-qarch” on page 97
- “-qflttrap” on page 138
- “-qstrict” on page 242
- “Implementation details of XL Fortran floating-point processing” in the *XL Fortran Optimization and Programming Guide*

-qfpp

Category

Input control

@PROCESS

None.

Purpose

Controls Fortran-specific preprocessing in the C preprocessor.

Syntax

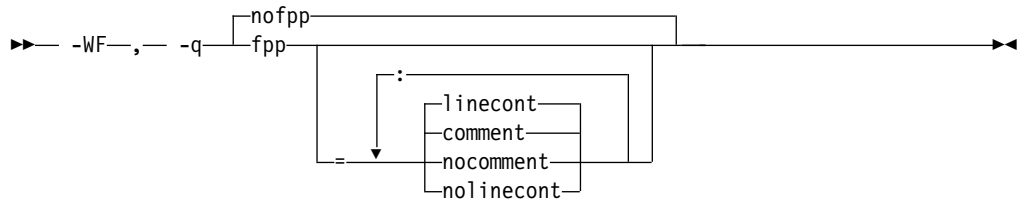

Defaults

- -qnofpp

Parameters

comment | nocomment

Instructs the C preprocessor (**cpp**) to recognize the ! character as a comment delimiter in macro expansion. When this suboption is enabled, the ! character and all characters following it on that line will be ignored by **cpp** when performing macro expansion.

linecont | no!inecont

Instructs **cpp** to recognize the & character as a line continuation character. When this suboption is enabled, **cpp** treats the & character and the C-style \ line continuation character equivalently.

Specifying **-qfpp** without any suboptions is equivalent to **-qfpp=comment:linecont**.

Usage

-qfpp is a C preprocessor option, and must therefore be specified using the **-WF** option.

Related information

- “-W, -X” on page 283
- “-qppsuborigarg” on page 213
- “Passing Fortran files through the C preprocessor” on page 32

-qflttrap

Category

Error checking and debugging

Purpose

Determines what types of floating-point exceptions to detect at run time.

The program receives a **SIGFPE** signal when the corresponding exception occurs.

Syntax

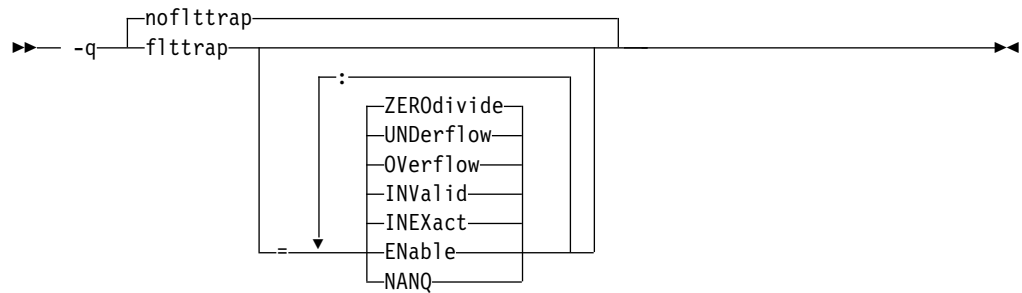

@PROCESS:

FLTTRAP[(*suboptions*)] | **NOFLTTRAP**

Defaults

-qnofltrap

Specifying **-qflttrap** option with no suboptions is equivalent to **-qflttrap=invalid:inexact:overflow:undflow:zerodivide**

Parameters

ENable

Turn on checking for the specified exceptions in the main program so that the exceptions generate **SIGFPE** signals. You must specify this suboption if you want to turn on exception trapping without modifying your source code.

INEXact

Detect and trap on floating-point inexact if exception-checking is enabled. Because inexact results are very common in floating-point calculations, you usually should not need to turn this type of exception on.

INValid

Detect and trap on floating-point invalid operations if exception-checking is enabled.

NANQ

Detect and trap on all quiet not-a-number values (NaNQs) and signaling not-a-number values (NaNSs). Trapping code is generated regardless of specifying the **enable** suboption. This suboption detects all NaN values handled by or generated by floating-point instructions, including those not created by invalid operations. This option can impact performance.

OVerflow

Detect and trap on floating-point overflow if exception-checking is enabled.

UNDerflow

Detect and trap on floating-point underflow if exception-checking is enabled.

ZERODivide

Detect and trap on floating-point division by zero if exception-checking is enabled.

Usage

Exceptions will be detected by the hardware, but trapping is not enabled. Because this default does not include **enable**, it is probably only useful if you already use **fpsets** or similar subroutines in your source.

If you specify **-qflttrap** more than once, both with and without suboptions, the **-qflttrap** without suboptions is ignored.

The **-qflttrap** option is recognized during linking with IPA. Specifying the option at the link step overrides the compile-time setting.

Note: Due to the transformations performed and the exception handling support of some vector instructions, use of **-qsimd=auto** may change the location where an exception is caught or even cause the compiler to miss catching an exception.

For full instructions on how and when to use the **-qflttrap** option, especially if you are just starting to use it, see the *Detecting and trapping floating-point exceptions* topic in *XL Fortran Optimization and Programming Guide*.

Example

```
REAL :: x, y, z
DATA x /5.0/, y /0.0/
z = x / y
PRINT *, z
END
```

When you compile this program with the following command, the program stops when the division is performed.

```
xlf -qflttrap=zerodivide:enable -qsigtrap divide_by_zero.f
```

The **zerodivide** suboption identifies the type of exception to guard against. The **enable** suboption causes a **SIGFPE** signal to be generated when the exception occurs. The **-qsigtrap** option produces informative output when the signal stops the program.

Related information

- *Detecting and trapping floating-point exceptions*
- “-qfloat” on page 134
- “-qarch” on page 97
- “-qsigtrap” on page 228

-qfree

Category

Input control

Purpose

Indicates that the source code is in free source form.

Syntax





@PROCESS:

```
@PROCESS FREE[({F90|IBM})]
```

Defaults

-qfree by itself specifies Fortran 90 free source form.

-qfixed=72 is the default for the **xl**f and **xl**f_r invocation commands when they are used to compile the .f, .F, .f77, or .F77 files. **-qfixed=72** is also the default for the **f77** and **fort77** invocation commands.

-qfree=f90 is the default for the **f90**, **xl**f90, **xl**f90_r, **f95**, **xl**f95, **xl**f95_r, **f2003**, **xl**f2003, **xl**f2003_r, **f2008**, **xl**f2008, **xl**f2008_r, and  **xl**cuf  commands.

Parameters

ibm

Specifies compatibility with the free source form defined for VS FORTRAN.

f90

Specifies compatibility with the free source form defined for Fortran 90.

Note that the free source form defined for Fortran 90 also applies to Fortran 95, Fortran 2003, and Fortran 2008.

Usage

The source form specified when executing the compiler applies to all of the input files, although you can switch the form for a compilation unit by using a **FREE** or **FIXED @PROCESS** directive or for the rest of the file by using a **SOURCEFORM** comment directive (even inside a compilation unit).

Fortran 90 free source form is the format to use for maximum portability across compilers that support Fortran 90 and Fortran 95 features now and in the future.

IBM free source form is equivalent to the free format of the IBM VS FORTRAN compiler, and it is intended to help port programs from the z/OS[®] platform.

-k is equivalent to **-qfree=f90**.

Related information

- “-qfixed” on page 131
- “-k” on page 81
- Free source form in the *XL Fortran Language Reference*

-qfullpath

Category

Error checking and debugging

@PROCESS

None.

Purpose

When used with the **-g** or **-qlinedebug** option, this option records the full, or absolute, path names of source and include files in object files compiled with debugging information, so that debugging tools can correctly locate the source files.

Syntax

►► -q nofullpath
fullpath ►►

Defaults

By default, the compiler records the relative path names of the original source file in each **.o** file. It may also record relative path names for include files.

Usage

If you need to move an executable file into a different directory before debugging it or have multiple versions of the source files and want to ensure that the debugger uses the original source files, use the **-qfullpath** option in combination with the **-g** or **-qlinedebug** option so that source-level debuggers can locate the correct source files.

Although **-qfullpath** works without the **-g** or **-qlinedebug** option, you cannot do source-level debugging unless you also specify the **-g** or **-qlinedebug** option.

Examples

In this example, the executable file is moved after being created, but the debugger can still locate the original source files:

```
$ xlf95 -g -qfullpath file1.f file2.f file3.f -o debug_version
...
$ mv debug_version $HOME/test_bucket
$ cd $HOME/test_bucket
$ gdb debug_version
```

Related information

- “-g” on page 77
- “-qlinedebug” on page 179

-qfunctrace

Category

Error checking and debugging

@PROCESS

None.

Purpose

Traces entry and exit points of procedures in your program. If your program contains C++ compilation units, this option also traces C++ catch blocks.

Syntax

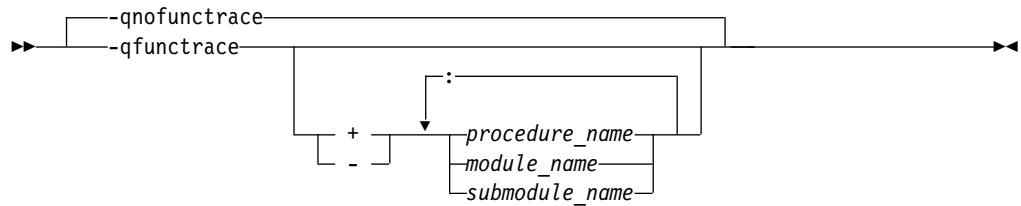

Defaults

-qnofunctrace

Parameters

- + Instructs the compiler to trace the specified program, procedures, or module procedures. All their internal procedures are traced by default.
- Instructs the compiler not to trace the specified program, procedures, module procedures, or any of their internal procedures.

procedure_name

The name of a program, external procedure, or module procedure. The name is case sensitive when **-qmixed** is in effect. **BIND(C)** binding labels and mangled module procedure names are allowed, but they must have the correct case. If **-qextname** is in effect, *procedure_name* is the name of the procedure without the additional underscore.

module_name

The name of a module. The name is case sensitive when **-qmixed** is in effect.

> F2008 *submodule_name*

The name of a submodule. The name is case sensitive when **-qmixed** is in effect. **F2008**

Usage

-qfunctrace enables tracing for all procedures in your program. **-qnofunctrace** disables tracing that was enabled by **-qfunctrace**.

The **-qfunctrace+** and **-qfunctrace-** suboptions enable tracing for a specific list of procedures and are not affected by **-qnofunctrace**. The list of procedures is cumulative. When a module procedure and its containing module **> F2008** or submodule **F2008** are both specified, the procedure specification takes precedence.

This option inserts calls to the tracing procedures that you have defined. These procedures must be provided at the link step. For details about the interface of tracing procedures, as well as when they are called, see the Trace procedures in your code section in the *XL Fortran Optimization and Programming Guide*.

Examples

The following table provides some examples of using the **-qfunctrace** option to achieve different purposes.

Purpose	Usage example
Tracing all procedures	-qfunctrace
Tracing procedures <i>x</i> , <i>y</i> , and <i>z</i>	-qfunctrace+x:y:z
Tracing all procedures except <i>x</i>	-qfunctrace -qfunctrace-x or -qfunctrace-x -qfunctrace
Tracing only procedures <i>x</i> and <i>y</i>	-qfunctrace+x -qfunctrace+y or -qfunctrace+x -qnofunctrace -qfunctrace+y
Tracing only procedure <i>y</i>	-qfunctrace+y -qnofunctrace or -qfunctrace+y
Tracing all the module procedures, except procedure <i>x</i> , in module <i>y</i>	-qfunctrace-x -qfunctrace+y or -qfunctrace+y -qfunctrace-x

Related information

- “-qfunctrace_xlf_catch”
- “-qfunctrace_xlf_enter” on page 145
- “-qfunctrace_xlf_exit” on page 146
- For details about the directives that you can use to specify the name of the tracing procedures, see the **FUNCTRACE_XLF_CATCH**, **FUNCTRACE_XLF_ENTER**, **FUNCTRACE_XLF_EXIT** sections in the *XL Fortran Language Reference*.
- For details about the rules for using the **NOFUNCTRACE** directive, see **NOFUNCTRACE** in the *XL Fortran Language Reference*.
- For detailed information about how to implement procedure tracing routines in your code, as well as detailed examples and a list of rules for using them, see **Tracing procedures in your code** in the *XL Fortran Optimization and Programming Guide*.

-qfunctrace_xlf_catch

Category

Error checking and debugging

@PROCESS

None.

Purpose

Specifies the name of the catch tracing subroutine.

Syntax

►►—qfunctrace_xlf_catch—==—catch_routine—◀◀

Defaults

Not applicable.

Parameters

catch_routine

Indicates the name of the catch tracing subroutine.

Usage

You use the **-qfunctrace_xlf_catch** option to specify that the external or module procedure being compiled must be used as a catch tracing procedure.

Note:

- If you write a tracing subroutine, make sure that the program does not contain any user procedures called `__func_trace_catch`.
- You must not specify the name of an internal subroutine when you use the **-qfunctrace_xlf_catch** option.

Related information

- The **FUNCTRACE_XLF_CATCH** directive in the *XL Fortran Language Reference*.
- “-qfunctrace” on page 142
- “-qfunctrace_xlf_enter”
- “-qfunctrace_xlf_exit” on page 146
- For detailed information about how to implement the tracing procedures in your code, see **Tracing procedures in your code** in the *XL Fortran Optimization and Programming Guide*.

-qfunctrace_xlf_enter

Category

Error checking and debugging

@PROCESS

None.

Purpose

Specifies the name of the entry tracing subroutine.

Syntax

►► `-qfunctrace_xlf_enter=enter_routine` ◀◀

Defaults

Not applicable.

Parameters

enter_routine

Indicates the name of the entry tracing subroutine.

Usage

You use the `-qfunctrace_xlf_enter` option to specify that the external or module procedure being compiled must be used as an entry tracing procedure.

Note:

- If you write a tracing subroutine, make sure that the program does not contain any user procedures called `__func_trace_enter`.
- You must not specify the name of an internal subroutine when you use the `-qfunctrace_xlf_enter` option.

Related information

- The `FUNCTRACE_XLF_ENTER` directive in the *XL Fortran Language Reference*.
- “`-qfunctrace`” on page 142
- “`-qfunctrace_xlf_catch`” on page 144
- “`-qfunctrace_xlf_exit`”
- For detailed information about how to implement the tracing procedures in your code, see **Tracing procedures in your code** in the *XL Fortran Optimization and Programming Guide*.

`-qfunctrace_xlf_exit`

Category

Error checking and debugging

@PROCESS

None.

Purpose

Specifies the name of the exit tracing subroutine.

Syntax

▶ `--qfunctrace_xlf_exit=exit_routine` ▶

Defaults

Not applicable.

Parameters

exit_routine

Indicates the name of the exit tracing subroutine.

Usage

You use the `-qfunctrace_xlf_exit` option to specify that the external or module procedure being compiled must be used as an exit tracing procedure.

Note:

- If you write a tracing subroutine, make sure that the program does not contain any user procedures called `__func_trace_exit`.

- You must not specify the name of an internal subroutine when you use the `-qfunctrace_xlf_exit` option.

Related information

- The `FUNCTRACE_XLF_EXIT` directive in the *XL Fortran Language Reference*.
- “`-qfunctrace`” on page 142
- “`-qfunctrace_xlf_catch`” on page 144
- “`-qfunctrace_xlf_exit`” on page 146
- For detailed information about how to implement the tracing procedures in your code, see **Tracing procedures in your code** in the *XL Fortran Optimization and Programming Guide*.

-qhalt

Category

Error checking and debugging

Purpose

Stops compilation before producing any object, executable, or assembler source files if the maximum severity of compile-time messages equals or exceeds the severity you specify.

Syntax



Notes:

- 1 Minimum severity level of messages that will prevent an object file from being created

@PROCESS:

@PROCESS HALT(*severity*)

Defaults

`-qhalt=s`, which prevents the compiler from generating an object file when compilation fails.

Parameters

The severity levels (from lowest to highest) are:

- i** Informational messages. They explain things that you should know, but they usually do not require any action on your part.
- l** Language-level messages, such as those produced under the `-qlanglvl` option. They indicate possible nonportable language constructs.
- w** Warning messages. They indicate error conditions that might require action on your part, but the program is still correct.

- e Error messages. They indicate error conditions that require action on your part to make the program correct, but the resulting program can probably still be executed.
- s Severe error messages. They indicate error conditions that require action on your part to make the program correct, and the resulting program will fail if it reaches the location of the error. You must change the **-qhalt** setting to make the compiler produce an object file when it encounters this kind of error.
- u Unrecoverable error messages. They indicate error conditions that prevent the compiler from continuing. They require action on your part before you can compile your program.

Usage

The **-qhalt** option can override the **-qobject** option, and **-qnoobject** can override **-qhalt**.

Related information

- “-qflag” on page 132
- “-qhaltmsg”
- “-qmaxerr” on page 188
- “-qobject” on page 196

-qhaltmsg

Category

Error checking and debugging

Purpose

Stops compilation before producing any object files, executable files, or assembler source files if a specified error message is generated.

Syntax

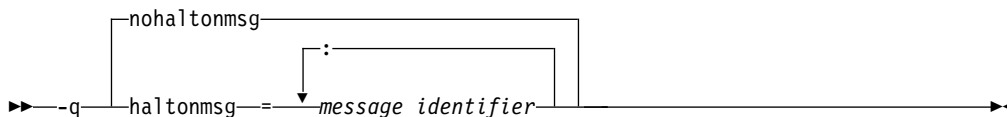

@PROCESS:

@PROCESS HALTONMSG(*message_identifier* [, *message_identifier* [, ...]]) | NOHALTONMSG

Defaults

-qnohaltmsg

Parameters

message_identifier[:*message_identifier* ...]

Stops compilation before producing any object files, executable files, or assembler source files if a specified error message (*nnnn-mmmm*) or a list of messages (*nnnn-mmmm[:nnnn-mmmm ...]*) is generated. To specify a list of messages, separate each message number with a colon.

nnnn-mmm is the message number, where:

- *nnnn* must be a four-digit integer between 1500 and 1585; this is the range of XL Fortran message numbers.
- *mmm* must be any three-digit integer (with leading zeros if necessary).

Usage

When the compiler stops as a result of the **-qhaltmsg** option, the compiler return code is nonzero. The severity level of a message that is specified by **-qhaltmsg** is changed to S if its original severity level is lower than S.

If **-qflag=u:u** or **-qflag=q:q** is specified, the message specified by **-qhaltmsg** is not shown.

-qhaltmsg has precedence over **-qsuppress** and **-qflag**.

Related information

- “-qhalt” on page 147
- “-qflag” on page 132
- “-qsuppress” on page 249

-qhelp

Category

Listings, messages, and compiler information

@PROCESS

None.

Purpose

Displays the man page of the compiler.

Syntax

►— -q—help—►

Usage

If you specify the **-qhelp** option, regardless of whether you provide input files, the compiler man page is displayed and the compilation stops.

Related information

- “-qversion” on page 260

-qhot

Category

Optimization and tuning

Purpose

Performs high-order loop analysis and transformations (HOT) during optimization.

The **-qhot** compiler option is a powerful alternative to hand tuning that provides opportunities to optimize loops and array language. This compiler option will always attempt to optimize loops, regardless of the suboptions you specify.

Syntax

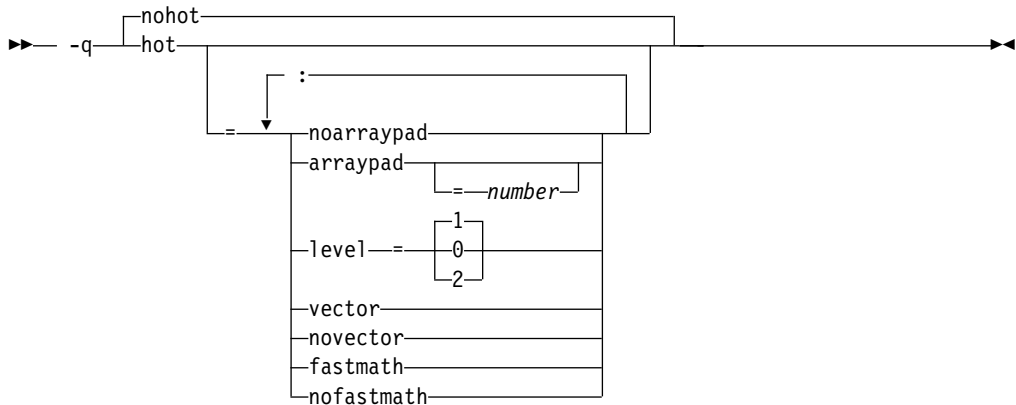

@PROCESS:

@PROCESS HOT[=suboptions] | **NOHOT**

Defaults

- **-qnohot**
- **-qhot=noarraypad:level=1:vector:fastmath** when **-qsmp**, **-O3**, **-O4**, **-O5** or **-Ofast** is in effect.
- Specifying **-qhot** without suboptions is equivalent to **-qhot=noarraypad:level=1:vector:fastmath**.

Parameters

arraypad | noarraypad

Permits the compiler to increase the dimensions of arrays where doing so might improve the efficiency of array-processing loops. (Because of the implementation of the cache architecture, array dimensions that are powers of two can lead to decreased cache utilization.) Specifying **-qhot=arraypad** when your source includes large arrays with dimensions that are powers of 2 can reduce cache misses and page faults that slow your array processing programs. This can be particularly effective when the first dimension is a power of 2. If you use this suboption with no *number*, the compiler will pad any arrays where it infers there may be a benefit and will pad by whatever amount it chooses. Not all arrays will necessarily be padded, and different arrays may be padded by different amounts. If you specify a *number*, the compiler will pad every array in the code.

Note: Using **arraypad** can be unsafe, as it does not perform any checking for reshaping or equivalences that may cause the code to break if padding takes place.

number

A positive integer value representing the number of elements by which each array will be padded in the source. The pad amount must be a positive integer value. To achieve more efficient cache utilization, it is recommended that pad values be multiples of the largest array element size, typically 4, 8, or 16.

level=0

Performs a subset of the high-order transformations and sets the default to **novector:noarraypad:fastmath**.

level=1

Performs the default set of high-order transformations.

level=2

Performs the default set of high-order transformations and some more aggressive loop transformations. This option performs aggressive loop analysis and transformations to improve cache reuse and exploit loop parallelization opportunities.

vector | novector

When specified with **-qnostrict** and an optimization level of **-O3** or higher, **vector** causes the compiler to convert certain operations that are performed in a loop on successive elements of an array (for example, square root, reciprocal square root) into a call to a routine in the Mathematical Acceleration Subsystem (MASS) library in libxlopt.

The **vector** suboption supports single-precision and double-precision floating-point mathematics, and is useful for applications with significant mathematical processing demands.

novector disables the conversion of loop array operations into calls to MASS library routines.

Because vectorization can affect the precision of your program results, if you are using **-O3** or higher, you should specify **-qhot=novector** if the change in precision is unacceptable to you.

fastmath | nofastmath

You can use this suboption to tune your application to either use fast scalar versions of math functions or use the default versions.

-qhot=fastmath enables the replacement of math routines with available math routines from the XLOPT library only if **-qstrict=nolibrary** is enabled.

-qhot=nofastmath disables the replacement of math routines by the XLOPT library. **-qhot=fastmath** is enabled by default if **-qhot** is specified regardless of the hot level.

Usage

If you do not also specify an optimization level when specifying **-qhot** on the command line, the compiler assumes **-O2**.

If you want to override the default **level** setting of 1 when using **-qsmp**, **-O3**, **-O4** or **-O5**, be sure to specify **-qhot=level=0** or **-qhot=level=2** *after* the other options.

If **-O2**, **-qnohot**, or **-qnoopt** is used on the command line, specifying HOT options in an **@PROCESS** directive will have no effect on the compilation unit.

The **-C** option turns off some array optimizations.

You can use the **-qreport** option in conjunction with **-qhot** or any optimization option that implies **-qhot** to produce a pseudo-Fortran report showing how the loops were transformed. The loop transformations are included in the listing report if either the **-qreport** or **-qlistfmt** option is also specified. This LOOP TRANSFORMATION SECTION of the listing file also contains information about data prefetch insertion locations. In addition, when you use **-qprefetch=assistthread** to generate prefetching assist threads, a message Assist thread for data prefetching was generated also appears in the LOOP TRANSFORMATION SECTION of the listing file. Specifying **-qprefetch=assistthread** guides the compiler to generate aggressive data prefetching at optimization level **-O3** or higher. For more information, see “-qreport” on page 220.

Related information

- “-qarch” on page 97
- “-C” on page 72
- “-qsimd” on page 229
- “-qreport” on page 220
- “-qlistfmt” on page 181
- “-O” on page 87
- “-qstrict” on page 242
- “-qsmp” on page 232
- *Using the Mathematical Acceleration Subsystem (MASS) in the XL Fortran Optimization and Programming Guide*
- *Directives for loop optimization in the XL Fortran Language Reference*
- *High-order transformation in the XL Fortran Optimization and Programming Guide*

-qieee

Category

Floating-point and integer control

Purpose

Specifies the rounding mode that the compiler will use when it evaluates constant floating-point expressions at compile time.

Syntax

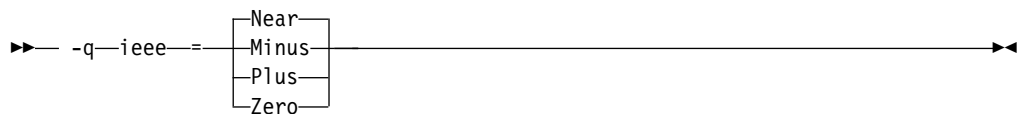

@PROCESS:

```
@PROCESS IEEE({Near | Minus | Plus | Zero})
```

Defaults

Near, which rounds to the nearest representable number.

Parameters

Near Round to nearest representable number.

Minus Round toward minus infinity.

Plus Round toward plus infinity.

Zero Round toward zero.

Usage

Use this option in combination with the XL Fortran subroutine **fpsets** or some other method of changing the rounding mode at run time. It sets the rounding mode that is used for compile-time arithmetic (for example, evaluating constant expressions such as **2.0/3.5**).

Specifying the same rounding mode for compile-time and runtime operations avoids inconsistencies in floating-point results.

Note: Compile-time arithmetic is most extensive when you also specify the **-O** option.

If you change the rounding mode from the default (round-to-nearest) at run time, be sure to also specify **-qfloat=rrm** to turn off optimizations that only apply in the default rounding mode.

If your program contains operations involving real(16) values, the rounding mode must be set to **-qieee=near**, round-to-nearest.

Related information

- *Selecting the rounding mode* in the *XL Fortran Optimization and Programming Guide*
- “**-O**” on page 87
- “**-qfloat**” on page 134

-qinfo

Category

Error checking and debugging

@PROCESS

None.

Purpose

Produces or suppresses groups of informational messages.

The messages are written to standard output and, optionally, to the listing file if one is generated.

Syntax

Option syntax

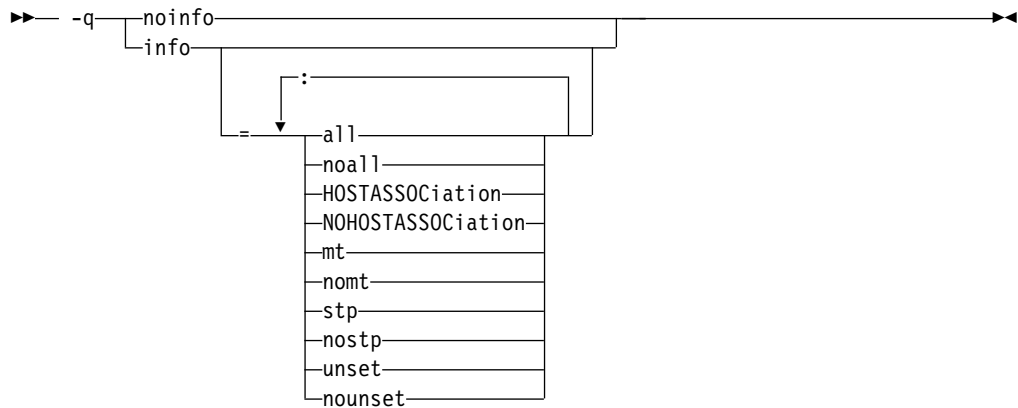

@PROCESS:

@PROCESS INFO[*suboptions*] | **NOINFO**

Defaults

-qnoinfo

Parameters

all

Enables diagnostic messages for all groups except **mt**.

noall (option only)

Disables all diagnostic messages for all groups.

mt | nomt

Reports potential synchronization issues in parallel code. This suboption detects the Global Thread Flag pattern where one thread uses a shared volatile flag variable to notify other threads that it has completed a computation and stored its result to memory. Other threads check the flag variable in a loop that does not change the flag variable. When the value of the flag variable changes, the waiting threads access the computation result from memory. The PowerPC storage model requires synchronization before the flag variable is set in the first thread, and after the flag variable is checked in the waiting threads. Synchronization can be done by the **LIGHT_SYNC** or **ISYNC** directive.

The type of synchronization directives you need to use depends on your code. Usually, it is enough to use the **LIGHT_SYNC** directive, as it preserves the storage access order to system memory. However, if the loops in the waiting threads are written in such a way that might cause instruction prefetching to start executing code that accesses the computation result before the flag variable is updated, you need to use the **ISYNC** directive to preserve order. Such patterns are typically as follows:

```

10 CALL sleep_(value)
   IF (.NOT. flag) GOTO 10
   ! The SYNC directive is needed here.
   x = shared_computation_result

```

Some patterns that do not require synchronization are similar to the patterns described above. The messages generated by this suboption are only suggestions about potential synchronization issues.

To use the **-qinfo=mt** suboption, you must enable the **-qthreaded** option and specify at least one of the following options:

- **-O3**
- **-O4**
- **-O5**
- **-qipa**
- **-qhot**
- **-qsmp**

The default option is **-qinfo=nomt**.

HOSTASSOCIATION | NOHOSTASSOCIATION

Issues an information message for an entity that is accessed by host association for the first time. However, if the entity is accessed by an **IMPORT** statement, no information message is issued.

You can use **-qinfo=all / noall** to control whether to enable the **-qinfo=HOSTASSOCIATION** option. The default option is **-qinfo=NOHOSTASSOCIATION**.

stp | nostp

Issues warnings for procedures that are not protected against stack corruption. **-qinfo=stp** has no effects unless the **-qstackprotect** option is also enabled. Like other **-qinfo** options, **-qinfo=stp** is enabled or disabled through **-qinfo=all / noall**. **-qinfo=nostp** is the default option.

unset | nounset

Detects automatic variables that are used before they are set, and flags them with informational messages at compile time.

-qinfo=unset uses program information, such as control flow information, available during optimization. As a result, detection accuracy improves with the optimization level. For example, some uses of unset variables that are not flagged at **-O0** are flagged at **-O2**. Aggressive optimization levels, such as **-O4** and **-O5**, can cause the line numbers in the informational messages to become inaccurate. In very rare cases, these optimization levels reorder the program sufficiently to cause false positive messages from static analysis. You can get the best results with the **-O2** optimization level.

The **-qinitauto** option initializes automatic variables. As a result, the **-qinitauto** option hides variables that are used before they are set from the **-qinfo=unset** option.

The **-qsave** option changes the storage class of automatic variables to **STATIC**. As a result, the **-qsave** option hides variables that are used before they are set from the **-qinfo=unset** option.

Usage

Specifying **-qinfo** with no suboptions is equivalent to **-qinfo=all**.

Specifying **-qnoinfo** is equivalent to **-qinfo=noall**.

Examples

To compile a program to produce informational messages about stack protection, enter the following command:

```
xlf90 myprogram.f -qinfo=stp -qstackprotect
```

To compile **t.f** to produce informational messages about host-associated variables, enter the following command:

```
xlf2008 t.f -qinfo=HOSTASSOCIATION
```

Suppose that t.f contains the following code:

```
PROGRAM p
  IMPLICIT none

  INTEGER :: var

  var = 3
  CALL sub()

  CONTAINS
    SUBROUTINE sub()
      PRINT *, var ! The compiler issues an information message when
                  ! entity 'var' is accessed by host association for
                  ! the first time.

      PRINT *, var ! No message is issued here.
    END

    INTEGER FUNCTION func()
      func = var ! Entity 'var' is in a different scope. The compiler
                ! issues an information message when the entity is
                ! accessed by host association for the first time in
                ! each scope.

    END
END
```

The compiler issues the following information messages:

```
"t.f", line 11.20: 1521-004 (I) Entity var is accessed by host association.
"t.f", line 16.18: 1521-004 (I) Entity var is accessed by host association.
```

To compile sync.f to produce informational messages about potential synchronization issues in parallel code, enter the following command:

```
xlf95_r -qinfo=mt -03 sync.f
```

Suppose that sync.f contains the following code:

```
MODULE m
  IMPLICIT NONE
  LOGICAL, VOLATILE :: done ! shared flag
  INTEGER, VOLATILE :: shared_result
  CONTAINS
    SUBROUTINE setter(id)
      IMPLICIT NONE
      INTEGER, INTENT(IN) :: id

      CALL sleep_(5)
      shared_result = 7
      ! !ibm* light_sync
      done = .TRUE. ! line 13
    END SUBROUTINE

    SUBROUTINE waiter(id)
      IMPLICIT NONE
      INTEGER, INTENT(IN) :: id

      DO WHILE (.NOT. done)
        CALL sleep_(1)
      END DO ! line 22
      ! !ibm* light_sync
      PRINT *, shared_result
    END SUBROUTINE
  END MODULE
```

```

PROGRAM MAIN
  USE m, ONLY: waiter, setter
  USE f_thread
  IMPLICIT NONE

  TYPE(f_thread_t) threads(2)
  TYPE(f_thread_attr_t) attr
  INTEGER(4) flag, result

  ! Initialization
  result = f_thread_attr_init(attr)
  IF (result /= 0) ERROR STOP 1
  flag = FLAG_DEFAULT

  ! Create threads
  result = f_thread_create(threads(1), attr, flag, waiter, 1)
  IF (result /= 0) ERROR STOP 2

  result = f_thread_create(threads(2), attr, flag, setter, 2)
  IF (result /= 0) ERROR STOP 3

  result = f_thread_join(threads(1))
  result = f_thread_join(threads(2))
END PROGRAM

```

The compiler issues the following informational message:

```

** m === End of Compilation 1 ===
** main === End of Compilation 2 ===

```

1586-669 (I) "sync.f", line 22: If this loop is used as a synchronization point, additional synchronization via a directive or built-in function might be needed.

1586-670 (I) "sync.f", line 13: If this statement is used as a synchronization point, additional synchronization via a directive or built-in function might be needed.

1501-510 Compilation successful for file sync.f.

The following function `factorial.f` does not initialize `temp` when `n<=1`. `factorial.f` also accesses `result` before it is set when `n>1`. With **-qinfo=unset** at **-qnoopt**, this issue is not detected. To compile `factorial.f` to produce informational messages about the uninitialized variables, enter the following command:

```
xlf95 -qinfo=unset -O factorial.f
```

`factorial.f` contains the following code:

```

module m
contains
  recursive function factorial(n) result(result)
    integer, value :: n
    integer result, temp

    if (n > 1) then
      temp = n * factorial(n - 1)
      print *, result ! line 9
    endif

    result = temp ! line 12
  end function
end module

use m
integer x
x = factorial(1)
end

```

The compiler issues the following informational messages:

```
1500-098 (I) "factorial.f", line 9: "result" is used before it is set.
1500-099 (I) "factorial.f", line 12: "temp" might be used before it is set.
1501-510 Compilation successful for file factorial.f.
```

Related information

- “-qreport” on page 220
- `isync` in the *XL Fortran Language Reference*
- `light_sync` in the *XL Fortran Language Reference*
- For more information about synchronization and the PowerPC storage model, see the article at <http://www.ibm.com/developerworks/systems/articles/powerpc.html>.

-qinit

Category

Language element control

Purpose

Makes the initial association status of pointers disassociated.

Note that this option applies to Fortran 90 and above.

Syntax

```
►► -q—init—==—f90ptr—►►
```

@PROCESS:

```
@PROCESS INIT(F90PTR)
```

Defaults

Not applicable.

Usage

You can use this option to help locate and fix problems that are due to using a pointer before you define it.

Related information

- See *Pointer association* in the *XL Fortran Language Reference*.

-qinitalloc

Category

Error checking and debugging

Purpose

Initializes allocatable and pointer variables that are allocated but not initialized to a specific value, for debugging purposes.

The **-qinitialloc** option applies to the following uninitialized variables:

- Variables that have the **ALLOCATABLE** attribute and are allocated using the **ALLOCATE** statement
- Variables that have the **POINTER** attribute and are allocated using the **ALLOCATE** statement

Syntax

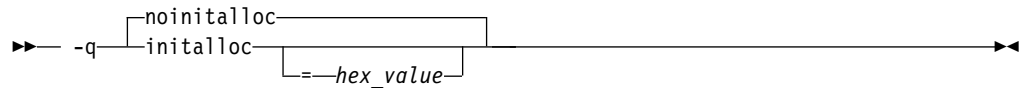

@PROCESS:

@PROCESS INITIALLOC[(*hex_value*)] | **NOINITALLOC**

Defaults

-qnoinitialloc

By default, the compiler does not initialize allocated storage to any particular value.

Parameters

hex_value

A one- to eight-digit hexadecimal number.

- If you do not specify a *hex_value*, the compiler initializes the value of each byte of allocated storage to zero.
- To initialize each byte of storage to a specific value, specify one or two digits for the *hex_value*. If you specify only one digit, the compiler pads the *hex_value* on the left with a zero.
- To initialize each word of storage to a specific value, specify three to eight digits for the *hex_value*. If you specify more than two but fewer than eight digits, the compiler pads the *hex_value* on the left with zeros.
- In the case of word initialization, if allocatable variables are not a multiple of 4 bytes in length, the *hex_value* is truncated on the left to fit. For example, if an allocatable variable is only 1 byte and you specify five digits for the *hex_value*, the compiler truncates the three digits on the left and assigns the other two digits on the right to the variable.
- You can specify alphabetic digits as either uppercase or lowercase.
- For derived type variables with default initialization, initialization with *hex_value* occurs before the default initialization. See Example 2.

Usage

The **-qinitialloc** option provides the following benefits:

- Setting *hex_value* to zero (the default value) ensures that all allocatable variables are cleared before being used.
- You can use this option to initialize variables of real or complex type to a signaling or quiet NaN, which helps locate uninitialized variables in your program.

The usage of this option is similar to that of the **-qinitauto** option. For more information, see “-qinitauto.”

Restriction: Objects that are equivalenced, structure components, and array elements are not initialized individually. Instead, the entire storage sequence is initialized collectively.

Examples

Example 1:

The following example shows how the **-qinitialloc** option works.

```
SUBROUTINE Sub()
  REAL(4), ALLOCATABLE :: a, b
  CHARACTER, ALLOCATABLE :: c
  REAL(8), ALLOCATABLE :: d

  ALLOCATE(a)                ! a is allocated but not initialized.
  ALLOCATE(b, SOURCE = 3.0)  ! b is allocated and initialized to 3.0.
  ALLOCATE(c)
  ALLOCATE(d)
END SUBROUTINE
```

If you compile your program with **-qinitialloc=0cf**, for example, the compiler performs the following initialization:

- Pads 0cf with five zeros and initializes a to 000000CF
- Keeps the original initialization for b
- Truncates the first digit of 0cf and initializes c to CF
- Pads 0cf with five zeros, repeats the value, and initializes d to 000000CF000000CF

Example 2:

The following example shows how the **-qinitialloc** option works when a derived type contains a component with default initialization.

```
TYPE dt
  INTEGER :: i = 1      ! i has default initialization
  INTEGER :: j
END TYPE
TYPE(dt), ALLOCATABLE :: dt1
ALLOCATE(dt1)
```

If you compile your program with **-qinitialloc**, the compiler keeps the default initialization for i, and initializes j to zero.

Related information

- The **ALLOCATABLE** attribute in the *XL Fortran Language Reference*
- The **ALLOCATE** statement in the *XL Fortran Language Reference*
- The **POINTER** statement in the *XL Fortran Language Reference*

-qinitauto

Category

Error checking and debugging

@PROCESS

None.

Purpose

Initializes uninitialized automatic variables to a specific value, for debugging purposes.

Syntax

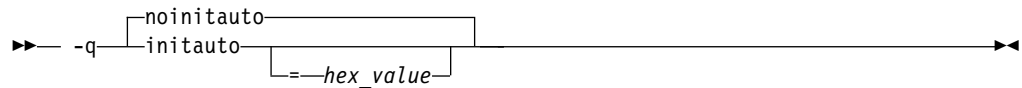

Defaults

-qnoinitauto

By default, the compiler does not initialize automatic storage to any particular value. However, it is possible that a region of storage contains all zeros.

Parameters

hex_value

A 1 to 8 digit hexadecimal number.

- If you do not specify a *hex_value* number, the compiler initializes the value of each byte of automatic storage to zero.
- To initialize each byte of storage to a specific value, specify 1 or 2 digits for the *hex_value*. If you specify only 1 digit, the compiler pads the *hex_value* on the left with a zero.
- To initialize each word of storage to a specific value, specify 3 to 8 digits for the *hex_value*. If you specify more than 2 but fewer than 8 digits, the compiler pads the *hex_value* on the left with zeros.
- In the case of word initialization, if automatic variables are not a multiple of 4 bytes in length, the *hex_value* may be truncated on the left to fit. For example, if you specify 5 digits for the *hex_value* and an automatic variable is only 1 byte long, the compiler truncates the 3 digits on the left-hand side of the *hex_value* and assigns the two right-hand digits to the variable.
- You can specify alphabetic digits as either upper- or lower-case.

Usage

This option helps you to locate variables that are referenced before being defined. For example, by using both the **-qinitauto** option to initialize **REAL** variables with a signaling NAN value and the **-qflttrap** option, it is possible to identify references to uninitialized **REAL** variables at run time.

Setting *hex_value* to zero ensures that all automatic variables are cleared before being used. Some programs assume that variables are initialized to zero and do not work when they are not. Other programs may work if they are not optimized but fail when they are optimized. Typically, setting all the variables to all zero bytes prevents such runtime errors. It is better to locate the variables that require zeroing

and insert code in your program to do so than to rely on this option to do it for you. Using this option will generally zero more things than necessary and may result in slower programs.

To locate and fix these errors, set the bytes to a value other than zero, which will consistently reproduce incorrect results. This method is especially valuable in cases where adding debugging statements or loading the program into a symbolic debugger makes the error go away.

Setting the *hex_value* to **FF** (255) gives **REAL** and **COMPLEX** variables an initial value of “negative not a number”, or quiet NAN. Any operations on these variables will also result in quiet NAN values, making it clear that an uninitialized variable has been used in a calculation.

This option can help you to debug programs with uninitialized variables in subprograms. For example, you can use it to initialize **REAL** variables with a signaling NAN value. You can initialize 8-byte **REAL** variables to double-precision signaling NAN values by specifying an 8-digit hexadecimal number, that, when repeated, has a double-precision signaling NAN value. For example, you could specify a number such as **7FBFFFFF**, that, when stored in a **REAL(4)** variable, has a single-precision signaling NAN value. The value **7FF7FFFF**, when stored in a **REAL(4)** variable, has a single-precision quiet NAN value. If the same number is stored twice in a **REAL(8)** variable (**7FF7FFFF7FF7FFFF**), it has a double-precision signaling NAN value.

Restrictions

Equivalenced variables, structure components, and array elements are not initialized individually. Instead, the entire storage sequence is initialized collectively.

Examples

The following example shows how to perform word initialization of automatic variables:

```
subroutine sub()
integer(4), automatic :: i4
character, automatic :: c
real(4), automatic :: r4
real(8), automatic :: r8
end subroutine
```

When you compile the code with the following option, the compiler performs word initialization, as the *hex_value* is longer than 2 digits:

```
-qinitauto=0cf
```

The compiler initializes the variables as follows, padding the *hex_value* with zeros in the cases of the *i4*, *r4*, and *r8* variables and truncating the first hexadecimal digit in the case of the *c* variable:

Variable	Value
i4	000000CF
c	CF
r4	000000CF
r8	000000CF000000CF

Related information

- “-qfltrap” on page 138
- The **AUTOMATIC** attribute in the *XL Fortran Language Reference*

-qinlglue

Category

Object code control

Purpose

When used with **-O2** or higher optimization, inlines glue code that optimizes external function calls in your application.

Glue code or Procedure Linkage Table code, generated by the linker, is used for passing control between two external functions. When **-qinlglue** is in effect, the optimizer inlines glue code for better performance. When **-qnoinlglue** is in effect, inlining of glue code is prevented.

Syntax

►► -q

inlglue
noinlglue

 ◀◀

@PROCESS:

@PROCESS **INLGLUE** | NOINLGLUE

Defaults

- **-qinlglue**

Usage

Inlining glue code can cause the code size to grow. Specifying **-qcompact** overrides the **-qinlglue** setting to prevent code growth. If you want **-qinlglue** to be enabled, do not specify **-qcompact**.

Specifying **-qnoinlglue** or **-qcompact** can degrade performance; use these options with discretion.

Related information

- “-qcompact” on page 111
- “-qtune” on page 255
- Inlining in the *XL Fortran Optimization and Programming Guide*
- Managing code size in the *XL Fortran Optimization and Programming Guide*

-qinline

Category

Optimization and tuning

@PROCESS

None.

Purpose

Attempts to inline procedures instead of generating calls to those procedures, for improved performance.

Syntax

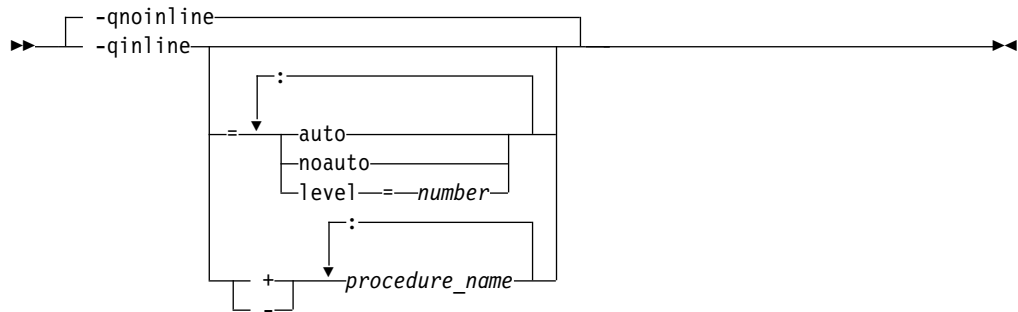

Defaults

If **-qinline** is not specified, the default option is as follows:

- **-qnoinline** at the **-O0** or **-qnoopt** optimization level
- **-qinline=noauto:level=5** at the **-O2** optimization level
- **-qinline=auto:level=5** at the **-O2 -qipa**, **-O3** or higher optimization level

If **-qinline** is specified without any suboptions, the default option is **-qinline=auto:level=5**.

Parameters

auto | **noauto**

Enables or disables automatic inlining. When option **-qinline=auto** is in effect, all the procedures are considered for inlining by the compiler. When option **-qinline=noauto** is in effect, the compiler only inlines small procedures that it deems appropriate for inlining.

level=number

Indicates the relative degree of inlining. The values for *number* must be integers in the range 0 - 10 inclusive. The default value for *number* is 5. The greater the value of *number*, the more aggressive inlining the compiler conducts.

procedure_name

If *procedure_name* is specified after the **-qinline+** option, the named procedure must be inlined. If *procedure_name* is specified after the **-qinline-** option, the named procedure must not be inlined.

Usage

You can specify **-qinline** with any optimization level of **-O2**, **-O3**, **-O4**, or **-O5** to enable inlining of procedures.

When **-qinline** is in effect, the compiler determines whether inlining a specific procedure can improve performance. That is, whether a procedure is appropriate for inlining is subject to two factors: limits on the number of inlined calls and the amount of code size increase as a result. Therefore, enabling inlining a procedure does not guarantee that procedure will be inlined.

Because inlining does not always improve runtime performance, you need to test the effects of this option on your code. Do not attempt to inline recursive or mutually recursive procedures.

You can use the **-qinline+<procedure_name>** or **-qinline-<procedure_name>** option to specify the procedures that must be inlined or must not be inlined.

Specifying **-qnoinline** disables all inlining, including that achieved by the high-level optimizer with the **-qipa** option.

If you specify the **-g** option to generate debugging information, the inlining effect of **-qinline** might be suppressed.

If you specify the **-qcompact** option to avoid optimizations that increase code size, the inlining effect of **-qinline** might be suppressed.

By default, **-qinline** affects only internal or module procedures. To turn on inline expansion for calls to procedures in different scopes, you must also use the **-qipa** option.

Conflicting **@PROCESS** directives or compilation options that are applied to different compilation units can impact inlining effectiveness. For example, if you specify inlining for a procedure, some **@PROCESS** compiler directives can be rendered ineffective. See the *XL Fortran Optimization and Programming Guide* for more information about inlining and IPA.

If you specify inlining for a procedure, the following **@PROCESS** compiler directives are only effective if they come before the first compilation unit in the file: **ALIAS**, **ALIGN**, **ATTR**, **COMPACT**, **DBG**, **EXTCHK**, **EXTNAME**, **FLOAT**, **FLTTRAP**, **HALT**, **IEEE**, **LIST**, **MAXMEM**, **OBJECT**, **OPTIMIZE**, **PHSINFO**, **SPILLSIZE**, **STRICT**, and **XREF**.

Examples

Example 1

To compile `myprogram.f` so that no procedures are inlined, use the following command:

```
xlf myprogram.f -O2 -qnoinline
```

If you want to enable automatic inlining, you use the `auto` suboption:

```
-O2 -qinline=auto
```

You can specify an inlining level 6 - 10 to achieve more aggressive automatic inlining. For example:

```
-O2 -qinline=auto:level=7
```

If automatic inlining is already enabled by default and you want to specify an inlining level of 7, you enter:

```
-O2 -qinline=level=7
```

Example 2

Assuming `myprogram.f` contains the `salary`, `taxes`, `expenses`, and `benefits` procedures, you can use the following command to compile `myprogram.f` to inline these procedures:

```
xlf myprogram.f -O2 -qinline+salary:taxes:expenses:benefits
```

If you do not want the procedures `salary`, `taxes`, `expenses`, and `benefits` to be inlined, use the following command to compile `myprogram.f`:

```
xlf myprogram.f -O2 -qinline-salary:taxes:expenses:benefits
```

You can also disable automatic inlining and specify certain procedures to be inlined with the **-qinline+** option. Consider the following example:

```
-O2 -qinline=noauto -qinline+salary:taxes:benefits
```

In this case, the procedures `salary`, `taxes`, and `benefits` are inlined. Procedures that are declared with the `inline` specifier are also inlined. No other procedures are inlined.

You cannot mix the `+` and `-` suboptions with each other or with other **-qinline** suboptions. For example, the following options are invalid suboption combinations:

```
-qinline+increase-decrease // Invalid  
-qinline=level=5+increase // Invalid
```

However, you can use multiple **-qinline** options separately. See the following example:

```
-qinline+increase -qinline-decrease -qinline=noauto:level=5
```

Related information

- “-g” on page 77
- “-qipa” on page 169
- “Interprocedural analysis” in the *XL Fortran Optimization and Programming Guide*
- The `-qinline` inlining option in the *XL Fortran Optimization and Programming Guide*

-qintlog

Category

Floating-point and integer control

Purpose

Specifies that you can mix integer and logical data entities in expressions and statements.

Syntax

```
►► -q nointlog  
intlog ◀◀
```

@PROCESS:

@PROCESS INTLOG | NOINTLOG

Defaults

-qnointlog

Usage

When **-qintlog** is specified, logical operators that you specify with integer operands act upon those integers in a bit-wise manner, and integer operators treat the contents of logical operands as integers.

The following operations do not allow the use of logical variables:

- **ASSIGN** statement variables
- Assigned **GOTO** variables
- **DO** loop index variables
- Implied-**DO** loop index variables in **DATA** statements
- Implied-**DO** loop index variables in either input and output or array constructors
- Index variables in **FORALL** constructs

You can also use the intrinsic functions **IAND**, **IOR**, **IEOR**, and **NOT** to perform bitwise logical operations.

The **MOVE_ALLOC** intrinsic function cannot take one integer and one logical argument.

Examples

```
INTEGER I, MASK, LOW_ORDER_BYTE, TWOS_COMPLEMENT
I = 32767
MASK = 255
! Find the low-order byte of an integer.
LOW_ORDER_BYTE = I .AND. MASK
! Find the twos complement of an integer.
TWOS_COMPLEMENT = (.NOT. I) + 1
END
```

Related information

- **-qport=clogicals** option.

-qintsize

Category

Floating-point and integer control

Purpose

Sets the size of default **INTEGER** and **LOGICAL** data entities that have no length or kind specified.

This option is not intended as a general-purpose method for increasing the sizes of data entities. Its use is limited to maintaining compatibility with code that is written for other systems.

Syntax

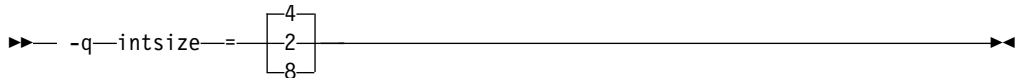

@PROCESS:

@PROCESS INTSIZE(*bytes*)

Defaults

-qintsize=4

Parameters

bytes

Allowed sizes are 2, 4, or 8.

Usage

This option is intended to allow you to port programs unchanged from systems that have different default sizes for data. For example, you might need **-qintsize=2** for programs that are written for a 16-bit microprocessor or **-qintsize=8** for programs that are written for a CRAY computer.

You might need to add **PARAMETER** statements to give explicit lengths to constants that you pass as arguments.

The specified size¹ applies to these data entities:

- **INTEGER** and **LOGICAL** specification statements with no length or kind specified.
- **FUNCTION** statements with no length or kind specified.
- Intrinsic functions that accept or return default **INTEGER** or **LOGICAL** arguments or return values unless you specify a length or kind in an **INTRINSIC** statement. Any specified length or kind must agree with the default size of the return value.
- Variables that are implicit integers or logicals.
- Integer and logical literal constants with no kind specified. If the value is too large to be represented by the number of bytes that you specified, the compiler chooses a size that is large enough. The range for 2-byte integers is $-(2^{15})$ to $2^{15}-1$, for 4-byte integers is $-(2^{31})$ to $2^{31}-1$, and for 8-byte integers is $-(2^{63})$ to $2^{63}-1$.
- Typeless constants in integer or logical contexts.
- In addition to types **INTEGER** and **LOGICAL**, **-qintsize** also works for **vector(integer)**. Specifying **-qintsize=2** is equivalent to specifying **vector(integer*2)**. Similarly, specifying **-qintsize=4** is equivalent to specifying **vector(integer*4)**. Specifying **-qintsize=8** is equivalent to **vector(integer*8)**.

Examples

In the following example, note how variables, literal constants, intrinsics, arithmetic operators, and input/output operations all handle the changed default integer size.

1. In Fortran 90/95 terminology, these values are referred to as *kind type parameters*.

```

@PROCESS INTSIZE(8)
PROGRAM INTSIZETEST
INTEGER I
I = -9223372036854775807 ! I is big enough to hold this constant.
J = ABS(I) ! So is implicit integer J.
IF (I .NE. J) THEN
PRINT *, I, '.NE.', J
END IF
END

```

The following example only works with the default size for integers:

```

CALL SUB(17)
END

SUBROUTINE SUB(I)
INTEGER(4) I ! But INTSIZE may change "17"
! to INTEGER(2) or INTEGER(8).

...
END

```

If you change the default value, you must either declare the variable I as **INTEGER** instead of **INTEGER(4)** or give a length to the actual argument, as follows:

```

@PROCESS INTSIZE(8)
INTEGER(4) X
PARAMETER(X=17)
CALL SUB(X) ! Use a parameter with the right length, or
CALL SUB(17_4) ! use a constant with the right kind.
END

```

Related information

- “-qrealsize” on page 217
- *Type declaration: type parameters and specifiers in the XL Fortran Language Reference*

-qipa

Category

Optimization and tuning

@PROCESS

None.

Purpose

Enables or customizes a class of optimizations known as interprocedural analysis (IPA).

IPA is a two-step process: the first step, which takes place during compilation, consists of performing an initial analysis and storing interprocedural analysis information in the object file. The second step, which takes place during linking, and causes a complete recompilation of the entire application, applies the optimizations to the entire program.

You can use **-qipa** during the compilation step, the link step, or both. If you compile and link in a single compiler invocation, only the link-time suboptions are relevant. If you compile and link in separate compiler invocations, only the compile-time suboptions are relevant during the compile step, and only the

link-time suboptions are relevant during the link step.

Syntax

-qipa compile-time syntax



-qipa link-time syntax

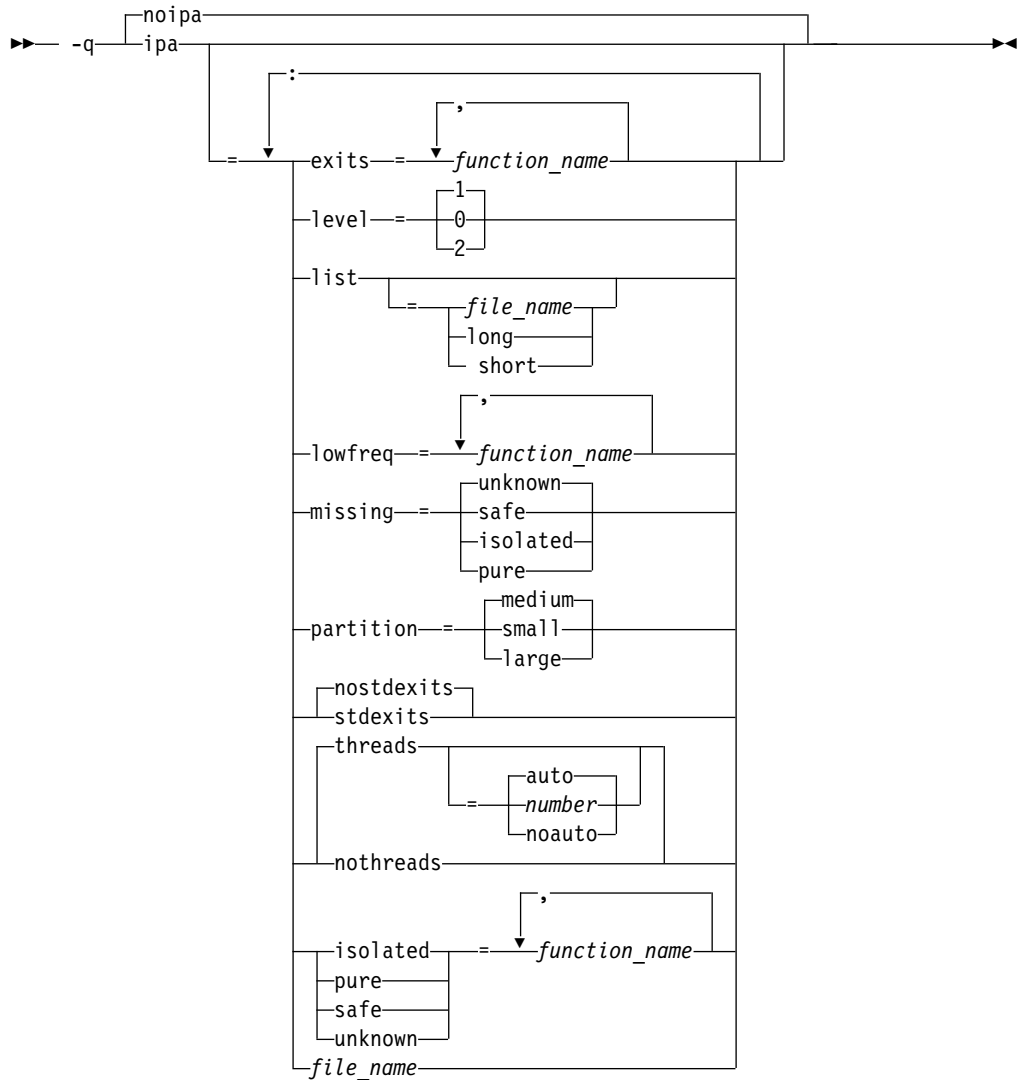

Defaults

- `-qnoipa`

Parameters

You can specify the following parameters during a separate compile step only:

object | noobject

Specifies whether to include standard object code in the output object files.

Specifying **noobject** can substantially reduce overall compile time by not generating object code during the first IPA phase. Note that if you specify **-S** with **noobject**, **noobject** will be ignored.

If compiling and linking are performed in the same step and you do not specify the **-S** or any listing option, **-qipa=noobject** is implied.

Specifying **-qipa** with no suboptions on the compile step is equivalent to **-qipa=object**.

You can specify the following parameters during a combined compile and link in the same compiler invocation, or during a separate link step only:

exits

Specifies names of procedures which represent program exits. Program exits are calls which can never return and can never call any procedure which has been compiled with IPA pass 1. The compiler can optimize calls to these procedures (for example, by eliminating save/restore sequences), because the calls never return to the program. These procedures must not call any other parts of the program that are compiled with **-qipa**.

isolated

Specifies a comma-separated list of procedures that are not compiled with **-qipa**. Procedures that you specify as *isolated* or procedures within their call chains cannot refer directly to any global variable.

level

Specifies the optimization level for interprocedural analysis. Valid suboptions are one of the following suboptions:

- 0** Performs only minimal interprocedural analysis and optimization.
- 1** Enables inlining, limited alias analysis, and limited call-site tailoring.
- 2** Performs full interprocedural data flow and alias analysis.

If you do not specify a level, the default is 1.

To generate data reorganization information, specify the optimization level **-qipa=level=2** or **-O5** together with **-qreport**. During the IPA link phase, the data reorganization messages for program variable data are written to the data reorganization section of the listing file. Reorganizations include common block splitting, array splitting, array transposing, memory allocation merging, array interleaving, and array coalescing.

list

Specifies that a listing file be generated during the link phase. The listing file contains information about transformations and analyses performed by IPA, as well as an optional object listing for each partition.

If you do not specify a *list_file_name*, the listing file name defaults to a.lst. If you specify **-qipa=list** together with any other option that generates a listing file, IPA generates an a.lst file that overwrites any existing a.lst file. If you have a source file named a.f, the IPA listing will overwrite the regular compiler listing a.lst. You can use the **-qipa=list=list_file_name** suboption to specify an alternative listing file name.

Additional suboptions are one of the following suboptions:

short Requests less information in the listing file. Generates the Object File Map, Source File Map and Global Symbols Map sections of the listing.

long Requests more information in the listing file. Generates all of the sections generated by the **short** suboption, plus the Object Resolution Warnings, Object Reference Map, Inliner Report and Partition Map sections.

lowfreq

Specifies procedures that are likely to be called infrequently. These are typically error handling, trace, or initialization procedures. The compiler may be able to make other parts of the program run faster by doing less optimization for calls to these procedures.

missing

Specifies the interprocedural behavior of procedures that are not compiled with **-qipa** and are not explicitly named in an **unknown**, **safe**, **isolated**, or **pure** suboption.

Valid suboptions are one of the following suboptions:

safe Specifies that the missing procedures do not indirectly call a visible (not missing) function either through direct call or through a procedure pointer.

isolated

Specifies that the missing procedures do not directly reference global variables accessible to visible procedures. Procedures bound from shared libraries are assumed to be *isolated*.

pure Specifies that the missing procedures are *safe* and *isolated* and do not indirectly alter storage accessible to visible procedures. *pure* procedures also have no observable internal state.

unknown

Specifies that the missing procedures are not known to be *safe*, *isolated*, or *pure*. This suboption greatly restricts the amount of interprocedural optimization for calls to missing procedures.

The default is to assume **unknown**.

partition

Specifies the size of each program partition created by IPA during pass 2. Valid suboptions are one of the following suboptions:

- **small**
- **medium**
- **large**

Larger partitions contain more procedures, which result in better interprocedural analysis but require more storage to optimize. Reduce the partition size if compilation takes too long because of paging.

pure

Specifies *pure* procedures that are not compiled with **-qipa**. Any procedure specified as *pure* must be *isolated* and *safe*, and must not alter the internal state or have side-effects, defined as potentially altering any data visible to the caller.

safe

Specifies *safe* procedures that are not compiled with **-qipa** and do not call any

other part of the program. Safe procedures can modify global variables and dummy arguments, but may not call procedures compiled with **-qipa**.

stdexits | nostdexports

Specifies that certain predefined routines can be optimized as with the **exits** suboption. The procedures are: `abort`, `exit`, `_exit`, and `_assert`.

threads | nothreads

Runs portions of the IPA optimization process during pass 2 in parallel threads, which can speed up the compilation process on multi-processor systems. Valid suboptions for the **threads** suboption are as follows:

auto | noauto

When **auto** is in effect, the compiler selects a number of threads heuristically based on machine load. When **noauto** is in effect, the compiler creates one thread per machine processor.

number

Instructs the compiler to use a specific number of threads. *number* can be any integer value in the range of 1 to 32 767. However, *number* is effectively limited to the number of processors available on your system.

Specifying **threads** with no suboptions implies **-qipa=threads=auto**.

unknown

Specifies *unknown* procedures that are not compiled with **-qipa**. Any procedure specified as *unknown* can make calls to other parts of the program compiled with **-qipa**, and modify global variables and dummy arguments.

file_name

Gives the name of a file which contains suboption information in a special format.

The file format is shown as follows:

```
# ... comment
attribute{, attribute} = name{, name}

missing = attribute{, attribute}
exits = name{, name}
lowfreq = name{, name}
list [ = file-name | short | long ]
level = 0 | 1 | 2
partition = small | medium | large
```

where *attribute* is one of:

- exits
- lowfreq
- unknown
- safe
- isolated
- pure

Usage

Specifying **-qipa** automatically sets the optimization level to **-O2**. For additional performance benefits, you can also specify the **-qinline** option. The **-qipa** option extends the area that is examined during optimization and inlining from a single procedure to multiple procedures (possibly in different source files) and the linkage between them.

If any object file used in linking with **-qipa** was created with the **-qipa=noobject** option, any file containing an entry point (the main program for an executable program, or an exported function for a library) must be compiled with **-qipa**.

You can link objects created with different releases of the compiler, but you must ensure that you use a linker that is at least at the same release level as the newer of the compilers used to create the objects being linked.

Some symbols which are clearly referenced or set in the source code may be optimized away by IPA, and may be lost to **debug** or **nm** outputs. Using IPA together with the **-g** compiler will usually result in non-steppable output.

Note that if you specify **-qipa** with **-#**, the compiler does not display linker information subsequent to the IPA link step.

For recommended procedures for using **-qipa**, see "Optimizing your applications" in the *XL Fortran Optimization and Programming Guide*.

Examples

The following example shows how you might compile a set of files with interprocedural analysis:

```
xlf -c *.f -qipa
xlf -o product *.o -qipa
```

Here is how you might compile the same set of files, improving the optimization of the second compilation, and the speed of the first compile step. Assume that there exist a set of routines, `user_trace1`, `user_trace2`, and `user_trace3`, which are rarely executed, and the routine `user_abort` that exits the program:

```
xlf95 -c *.f -qipa=noobject
xlf95 -c *.o -qipa=lowfreq=user_trace[123]:exit=user_abort
```

Related information

- `-qinline`
- "`-qlibmpi`" on page 178
- "`-S`" on page 278
- Correct settings for environment variables

-qkeepparm

Category

Error checking and debugging

@PROCESS

None.

Purpose

When used with **-O2** or higher optimization, specifies whether procedure parameters are stored on the stack.

A procedure usually stores its incoming parameters on the stack at the entry point. However, when you compile code with optimization options enabled, the

optimizer may remove these parameters from the stack if it sees an optimizing advantage in doing so.

Syntax

►► -q nokeepparm
keepparm ◀◀

Defaults

-qnokeepparm

Usage

When **-qkeepparm** is in effect, parameters are stored on the stack even when optimization is enabled. This option then provides access to the values of incoming parameters to tools, such as debuggers, simply by preserving those values on the stack. However, this may negatively impact execution performance.

When **-qnokeepparm** is in effect, parameters are removed from the stack if this provides an optimization advantage.

-qlanglvl

Category

Language element control

Purpose

Determines which language standard (or superset, or subset of a standard) to consult for nonconformance. It identifies nonconforming source code and also options that allow such nonconformances.

Syntax

►► -q-**langlvl** = :
extended
77std
90std
90pure
95std
95pure
2003std
2003pure
2008std
2008pure
ts
tspure ◀◀

@PROCESS:

@PROCESS **LANGLVL**({*suboption*})

Defaults

`-qlanglvl=extended`

Parameters

77std Accepts the language that the ANSI FORTRAN 77 standard specifies and reports anything else using language-level messages.

90std Accepts the language that the ISO Fortran 90 standard specifies and reports anything else using language-level messages.

90pure

The same as **90std** except that it also issues language-level messages for any obsolescent Fortran 90 features used.

95std Accepts the language that the ISO Fortran 95 standard specifies and reports anything else using language-level messages.

95pure

The same as **95std** except that it also issues language-level messages for any obsolescent Fortran 95 features used.

2003std

Accepts the language that the ISO Fortran 2003 standard specifies and reports anything else using language-level messages.

2003pure

The same as **2003std** except that it also issues language-level messages for any obsolescent Fortran 2003 features used.

2008std

Accepts the language that the ISO Fortran 2003 standard specifies and all Fortran 2008 features supported by XL Fortran, and reports anything else using language-level messages.

2008pure

The same as **2008std** except that it also issues language-level messages for any obsolescent Fortran 2008 features used.

ts Accepts the language that a standard technical specification specifies, and reports anything else using language-level messages. Technical Specification 29113 is an addition to the current Fortran standard. This option checks for the language that the ISO Fortran 2003 standard specifies, all supported ISO Fortran 2008 standard features, and all supported ISO TS 29113 features.

tspure The same as **ts** except that it also issues language-level messages for any obsolescent Technical Specification 29113 features used.

extended

Accepts the full Fortran 2003 language standard, all Fortran 2008 features supported by XL Fortran, and all extensions, effectively turning off language-level checking.

Usage

When a `-qlanglvl` setting is specified, the compiler issues a message with severity code **L** if it detects syntax that is not allowed by the language level that you specified.

The `-qflag` option can override the `-qlanglvl` option.

The **langlvl** runtime option, which is described in “Setting runtime options” on page 37, helps to locate runtime extensions that cannot be checked for at compile time.

Examples

The following example contains source code that conforms to a mixture of Fortran standards:

```
!-----
! in free source form
program tt
  integer :: a(100,100), b(100), i
  real :: x, y
  ...
  goto (10, 20, 30), i
10 continue
  pause 'waiting for input'

20 continue
  y= gamma(x)

30 continue
  b = maxloc(a, dim=1, mask=a .lt 0)

end program
!-----
```

The following table shows examples of how some **-qlanglvl** suboptions affect this sample program:

-qlanglvl Suboption Specified	Result	Reason
95pure	Flags PAUSE statement Flags computed GOTO statement Flags GAMMA intrinsic	Deleted feature in Fortran 95 Obsolescent feature in Fortran 95 Extension to Fortran 95
95std	Flags PAUSE statement Flags GAMMA intrinsic	Deleted feature in Fortran 95 Extension to Fortran 95
extended	No errors flagged	

Related information

- “-qflag” on page 132
- “-qhalt” on page 147
- “-qsaa” on page 222
- **langlvl** runtime option in “Setting runtime options” on page 37

-qlibansi

Category

Optimization and tuning

@PROCESS

None.

Purpose

Assumes that all functions with the name of an ANSI C library function are, in fact, the library functions and not a user function with different semantics.

Syntax

►► -q no libansi libansi _____►►

Defaults

-qnolibansi

Usage

This option will allow the optimizer to generate better code because it will know about the behavior of a given function, such as whether or not it has any side effects.

Note: Do not use this option if your application contains your own version of a library function that is incompatible with the standard one.

Related information

See “-qipa” on page 169.

-qlibmpi

Category

“Optimization and tuning” on page 62

@PROCESS

None

Purpose

Asserts that all functions with Message Passing Interface (MPI) names are in fact MPI functions and not a user function with different semantics.

Syntax

►► -q no libmpi libmpi _____►►

Defaults

-qnolibmpi

Usage

MPI is a library interface specification for message passing. It addresses the message-passing parallel programming model in which data is moved from the address space of one process to another through cooperative operations. For details about MPI, see the Message Passing Interface Forum.

-qlibmpi allows the compiler to generate better code because it knows about the behavior of a given function, such as whether or not it has any side effects.

When you use **-qlibmpi**, the compiler assumes that all functions with the name of an MPI library function are in fact MPI functions. **-qnolibmpi** makes no such assumptions.

Note: You cannot use this option if your application contains your own version of the library function that is incompatible with the standard one.

Examples

To compile `myprogram.f`, enter the following command:

```
xlf -O5 myprogram.f -qlibmpi
```

Related information

- Message Passing Interface Forum
- “-qipa” on page 169

-qlinedebug

Category

Error checking and debugging

Purpose

Generates only line number and source file name information for a debugger.

When **-qlinedebug** is in effect, the compiler produces minimal debugging information, so the resulting object size is smaller than that produced by the **-g** debugging option. You can use the debugger to step through the source code, but you will not be able to see or query variable information. The traceback table, if generated, will include line numbers.

-qlinedebug is equivalent to **-g1**.

Syntax

```
→ -q ————|——— no linedebug ———→  
          |——— linedebug
```

@PROCESS:

@PROCESS `LINEDebug` | `NOLINEDebug`

Defaults

`-qnolinedebug`

Usage

When **-qlinedebug** is in effect, function inlining is disabled.

As with all debugging information, the output of **-qlinedebug** might be incomplete or misleading if the code is optimized.

The **-g** option overrides the **-qlinedebug** option. If you specify **-g** with **-qnolinedebug** on the command line, **-qlinedebug** is ignored and a warning is issued.

Related information

- “-g” on page 77
- “-O” on page 87

-qlist

Category

Listings, messages, and compiler information

Purpose

Produces a compiler listing file that includes object and constant area sections.

When **-qlist** is in effect, a listing file is generated with a `.lst` suffix for each source file named on the command line.

Syntax

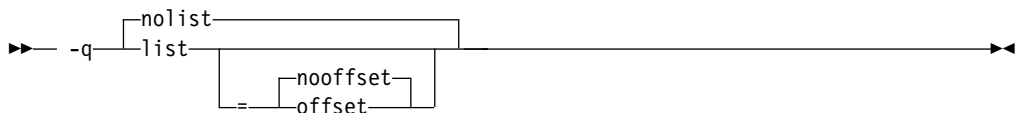

@PROCESS:

@PROCESS LIST[[([NO]OFFSET)] | **NOLIST**

Defaults

-qnolist

Parameters

offset | **nooffset**

When **-qlist=offset** is in effect, the listing will show the offset from the start of the procedure rather than the offset from the start of code generation. This suboption allows any program reading the `.lst` file to add the value of the PDEF and the line in question, and come up with the same value whether **offset** or **nooffset** is specified.

The **offset** suboption is relevant only if there are multiple procedures in a compilation unit. For example, this might occur if nested procedures are used in a program.

Specifying **-qlist** with no suboption is equivalent to **-qlist=nooffset**.

Usage

You can use the object listing to help understand the performance characteristics of the generated code and to diagnose execution problems.

If you specify `-qipa` and want to generate the IPA listing file, use the `-qipa=list=filename` suboption to get an alternative listing.

The `-qnoprint` compiler option overrides this option.

Related information

- “Listings, messages, and compiler information” on page 60
- “Object section” on page 312
- “-qnoprint” on page 194
- “-S” on page 278
- *Program units and procedures in the XL Fortran Language Reference*

-qlistfmt

Category

Listings, messages, and compiler information

@PROCESS

None.

Purpose

Creates a report in XML or HTML format to help you find optimization opportunities.

Syntax

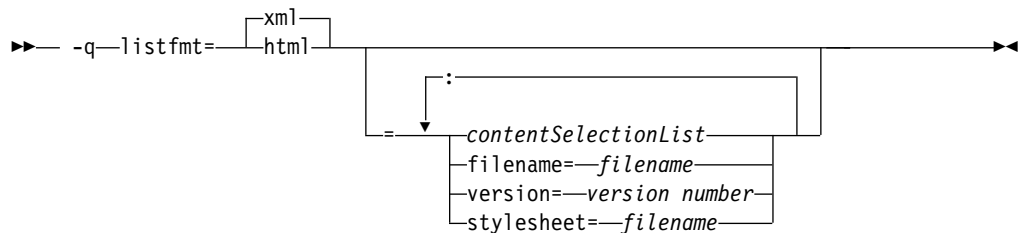

Defaults

This option is off by default. If none of the `contentSelectionList` suboptions is specified, all available report information is produced. For example, specifying `-qlistfmt=xml` is equivalent to `-qlistfmt=xml=all`.

Parameters

The following list describes `-qlistfmt` parameters:

xml | html

Instructs the compiler to generate the report in XML or HTML format. If an

XML report has been generated before, you can convert the report to the HTML format using the **genhtml** command. For more information about this command, see “genhtml” on page 288.

contentSelectionList

The following suboptions provide a filter to limit the type and quantity of information in the report:

data | **nodata**

Produces data reorganization information.

inlines | **noinlines**

Produces inlining information.

pdf | **nopdf**

Produces profile-directed feedback information.

transforms | **notransforms**

Produces loop transformation information.

all

Produces all available report information.

none

Does not produce a report.

filename

Specifies the name of the report file. One file is produced during the compile phase, and one file is produced during the IPA link phase. If no filename is specified, a file with the suffix `.xml` or `.html` is generated in a way that is consistent with the rules of name generation for the given platform. For example, if the `foo.f` file is compiled, the generated XML files are `foo.xml` from the compile step and `a.xml` from the link step.

Note: If you compile and link in one step and use this suboption to specify a file name for the report, the information from the IPA link step will overwrite the information generated during the compile step.

The same will be true if you compile multiple files using the `filename` suboption. The compiler creates an report for each file so the report of the last file compiled will overwrite the previous reports. For example,

```
xlf -qlistfmt=xml=all:filename=abc.xml -O3 myfile1.f myfile2.f myfile3.f
```

will result in only one report, `abc.xml` based on the compilation of the last file `myfile3.f`.

stylesheet

Specifies the name of an existing XML stylesheet for which an `xml-stylesheet` directive is embedded in the resulting report. The default behavior is to not include a stylesheet. The stylesheet supplied with XL Fortran is `x1style.xml`. This stylesheet renders the XML report to an easily read format when the report is viewed through a browser that supports XSLT.

To view the XML report created with the **stylesheet** suboption, you must place the actual stylesheet (`x1style.xml`) and the XML message catalog (`XMLMessages-locale.xml` where *locale* refers to the locale set on the compilation machine) in the path specified by the **stylesheet** suboption. The stylesheet and message catalog are installed in the `/opt/ibm/xlf/15.1.5/listings/` directory.

For example, if `a.xml` is generated with `stylesheet=xlstyle.xsl`, both `xlstyle.xsl` and `XMLMessages-locale.xml` must be in the same directory as `a.xml`, before you can properly view `a.xml` with a browser.

version

Specifies the major version of the content that will be generated. If you have written a tool that requires a certain version of this report, you must specify the version.

For example, IBM XL Fortran for Linux, V15.1.5 creates reports at XML v1.1. If you have written a tool to consume these reports, specify `version=v1`.

Usage

The information produced in the report by the `-qlistfmt` option depends on which optimization options are used to compile the program.

- When you specify both `-qlistfmt` and an option that enables inlining such as `-qinline`, the report shows which functions were inlined and why others were not inlined.
- When you specify both `-qlistfmt` and an option that enables loop unrolling, the report contains a summary of how program loops are optimized. The report also includes diagnostic information about why specific loops cannot be vectorized. To make `-qlistfmt` generate information about loop transformations, you must also specify at least one of the following options:
 - `-qhot`
 - `-qsmp`
 - `-O3` or higher
- When you specify both `-qlistfmt` and an option that enables parallel transformations, the report contains information about parallel transformations. For `-qlistfmt` to generate information about parallel transformations or parallel performance messages, you must also specify at least one of the following options:
 - `-qsmp`
 - `-O5`
 - `-qipa=level=2`
- When you specify both `-qlistfmt` and `-qpdf`, which enables profiling, the report contains information about call and block counts and cache misses.
- When you specify both `-qlistfmt` and an option that produces data reorganizations such as `-qipa=level=2`, the report contains information about those reorganizations.

Examples

If you want to compile `myprogram.f` to produce an XML report that shows how loops are optimized, enter:

```
xlf -qhot -O3 -qlistfmt=xml=transforms myprogram.f
```

If you want to compile `myprogram.f` to produce an XML report that shows which functions are inlined, enter:

```
xlf -qinline -qlistfmt=xml=inlines myprogram.f
```

Related information

- “-qreport” on page 220
- “genhtml” on page 288

- "Using compiler reports to diagnose optimization opportunities" in the *XL Fortran Optimization and Programming Guide*

-qlistopt

Category

Listings, messages, and compiler information

Purpose

Produces a compiler listing file that includes all options in effect at the time of compiler invocation.

When **listopt** is in effect, a listing file is generated with a `.lst` suffix for each source file named on the command line. The listing shows options in effect as set by the compiler defaults, the configuration file, and command line settings.

Syntax

►► — -q —

nolistopt
listopt

 —►►

@PROCESS:

@PROCESS LISTOPT | NOLISTOPT

Defaults

-qnolistopt

Usage

You can use the option listing during debugging to check whether a problem occurs under a particular combination of compiler options, or during performance testing to record the optimization options in effect for a particular compilation.

Options that are always displayed in the listing include:

- All "on/off" options that are on by default: for example, **-qobject**
- All "on/off" options that are explicitly turned off through the configuration file, command-line options, or **@PROCESS** directives
- All options that take arbitrary numeric arguments (typically sizes)
- All options that have multiple suboptions

The **-qnoprint** compiler option overrides this option.

Related information

- "Listings, messages, and compiler information" on page 60
- "Options section" on page 307

-qlog4

Category

Portability and migration

Purpose

Specifies whether the result of a logical operation with logical operands is a **LOGICAL(4)** or is a **LOGICAL** with the maximum length of the operands.

You can use this option to port code that was originally written for the IBM VS FORTRAN compiler.

Syntax

►► -q no1og4 | 1og4 _____►►

@PROCESS:

@PROCESS LOG4 | **NOLOG4**

Defaults

-qnolog4, which makes the result depend on the lengths of the operands.

Usage

Specifying **-qlog4** makes the result a **LOGICAL(4)**.

If you use **-qintsize** to change the default size of logicals, **-qlog4** is ignored.

-qmakedep

Category

Output control

@PROCESS

None.

Purpose

Produces a dependency output file containing targets suitable for inclusion in a description file for the **make** command.

The dependency output file is named with a **.d** suffix.

-qmakedep is the long form of **-MMD**.

Syntax

►► -q-makedep _____►►
--gcc

Defaults

Not applicable.

Parameters

gcc

The format of the generated **make** rule to match the GCC format: the dependency output file includes a single target that lists all of the source file's dependencies.

If you specify **-qmkadep** with no suboption, the dependency output file specifies a separate rule for each of the source file's dependencies.

Usage

The **make** command uses dependency information to determine the compilation order of the files. The **make** command also uses the dependency information to determine the minimum set of files that must be recompiled when a file is changed.

XL Fortran recognizes the following types of source file dependencies:

- Dependencies on the files that are included through C preprocessor `#include` directives.
- Dependencies on the files that are included through the Fortran `INCLUDE` directive.
- Dependencies on the module symbol files in the files that use or extend one or more Fortran modules.
- **F2008** Dependencies on the submodule symbol files in the files that extend one or more Fortran submodules. **F2008**

For each source file that is named on the command line, a dependency output file is generated with the same name as the object file but with a `.d` suffix. Dependency output files are not created for any other types of input files. If you use the **-o** option to rename the object file, the name of the dependency output file is based on the name specified in the **-o** option. For more information, see the Examples section.

The dependency output files generated by these options are not **make** description files; they must be linked before they can be used with the **make** command. For more information about this command, see your operating system documentation.

If the **-qfullpath** option is also specified, the absolute path names of the source and include files are recorded in the dependency output file.

You can also use **-qmkadep** with the following options:

-MF *file_path*

Sets the name of the dependency output file, where *file_path* is the full or partial path or file name for the dependency output file. For more information, see “-MF” on page 83.

-MT *target*

Specifies the target name of the object file in the **make** rule in the generated dependency file. For more information, see “-MT” on page 85.

Examples

Example 1: To compile `mysource.f` and create a dependency output file named `mysource.d`, enter:

```
xlf -c -qmakedep mysource.f
```

Example 2: To compile `source.f` and create an object file named `object.o` and a dependency output file named `object.d`, enter:

```
xlf -c -qmakedep source.f -o object.o
```

Example 3: If you have the following files in the current working directory:

- `options.h`
- `constants.h`
- `n.F`
- `m.f`

The `options.h` file contains following code:

```
@PROCESS free(f90)
```

The `constants.h` file contains following code:

```
real(4), parameter :: pi = 3.14
```

The `n.F` file contains following code:

```
#include "options.h"
module n
contains
  subroutine my_print(x)
    real, value :: x
    print *, x
  end subroutine
end module
```

The `m.f` file contains following code:

```
#include "options.h"
module m
  use n
contains
  subroutine sub
    implicit none
    include 'constants.h'
    call my_print(pi)
  end subroutine
end module
```

To compile `n.F` and create a dependency output file named `n.d` in the `./dependencies` directory, enter:

```
xlf -c n.F -qmakedep -MF./dependencies -o n_obj.o
```

To compile `m.f` and create a dependency output file named `m.d` in the `./dependencies` directory, and also to include path information `/home/user/sample/` as part of the target name of the object file in the `m.d` file, enter:

```
xlf -c m.f -qmakedep -MF./dependencies -MT '/home/user/sample/m.o'
```

The generated `n.d` file is as follows:

```
n_obj.o n.mod: options.h
n_obj.o n.mod: n.F
```

The generated `m.d` file is as follows:

```

/home/user/sample/m.o m.mod: n.mod
/home/user/sample/m.o m.mod: option.h
/home/user/sample/m.o m.mod: m.f
/home/user/sample/m.o m.mod: constants.h

```

Related information

- “-qfullpath” on page 141
- “-MF” on page 83
- “-MT” on page 85
- “-o” on page 89

-qmaxerr

Category

Error checking and debugging

@PROCESS

@PROCESS MAXERR(*number*, *severity*) | NOMAXERR

Purpose

Stops compilation when the number of error messages of a specified severity level or higher reaches a specified number.

Syntax

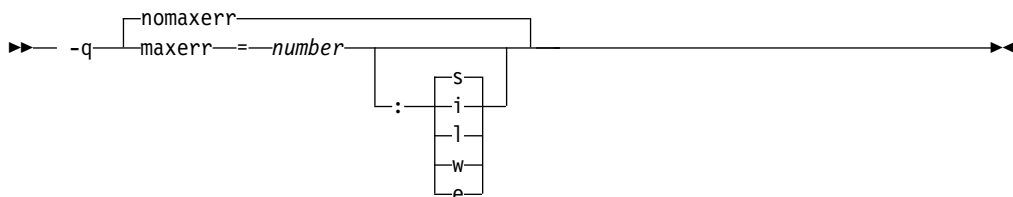

Defaults

-qnomaxerr

Parameters

number

It specifies the maximum number of messages the compiler generates before it stops. *number* must be an integer with a value of 1 or greater.

The severity levels (from lowest to highest) are listed as follows. See “Error severity” on page 299 for more information about these levels.

- i** Informational messages.
- l** Language-level messages, such as those produced under the **-qlanglvl** option.
- w** Warning messages.
- e** Error messages.
- s** Severe error messages.

Usage

If the **-qmaxerr** option does not specify the severity level, it uses the severity that is in effect by the **-qhalt** option; otherwise, the severity level is specified by either **-qmaxerr** or **-qhalt** that appears last.

When **-qflag** is specified, **-qmaxerr** counts the messages that are allowed by the **-qflag** option.

When **-qsuppress** is specified, **-qmaxerr** does not count the messages that are censored by the **-qsuppress** option.

Examples

To stop compilation of `myprogram.f` when 5 error messages are encountered, enter the following command:

```
xlf myprogram.f -qmaxerr=5:e
```

To stop compilation of `myprogram.f` when 5 severe errors are encountered, enter the following command:

```
xlf myprogram.f -qmaxerr=5
```

To stop compilation of `myprogram.f` when 5 language level messages are encountered, enter the following command:

```
xlf myprogram.f -qmaxerr=5:l
```

or:

```
xlf myprogram.f -qmaxerr=5 -qhalt=1
```

Related information

- “-qflag” on page 132
- “-qhalt” on page 147
- “-qsuppress” on page 249
- “Error severity” on page 299

-qmaxmem

Category

Optimization and tuning

Purpose

Limits the amount of memory that the compiler allocates while performing specific, memory-intensive optimizations to the specified number of kilobytes.

Syntax

►► — `-q—maxmem—=—Kbytes` —————►►

@PROCESS:

@PROCESS MAXMEM(*Kbytes*)

Defaults

- `maxmem=8192` when `-O2` is in effect.
- `maxmem=-1` when `-O3` or higher optimization is in effect.

Parameters

Kbytes

The number of kilobytes worth of memory to be used by optimizations. The limit is the amount of memory for specific optimizations, and not for the compiler as a whole. Tables required during the entire compilation process are not affected by or included in this limit.

A value of `-1` permits each optimization to take as much memory as it needs without checking for limits.

Usage

If the specified amount of memory is insufficient for the compiler to compute a particular optimization, the compiler issues a message and reduces the degree of optimization.

This option has no effect except in combination with the `-O` option.

When compiling with `-O2`, you only need to increase the limit if a compile-time message instructs you to do so. When compiling with `-O3`, you might need to establish a limit if compilation stops because the machine runs out of storage; start with a value of 8192 or higher, and decrease it if the compilation continues to require too much storage.

Notes:

1. Reduced optimization does not necessarily mean that the resulting program will be slower. It only means that the compiler cannot finish looking for opportunities to improve performance.
2. Increasing the limit does not necessarily mean that the resulting program will be faster. It only means that the compiler is better able to find opportunities to improve performance if they exist.
3. Setting a large limit has no negative effect when compiling source files for which the compiler does not need to use so much memory during optimization.
4. As an alternative to raising the memory limit, you can sometimes move the most complicated calculations into procedures that are then small enough to be fully analyzed.
5. Not all memory-intensive compilation stages can be limited.
6. Only the optimizations done for `-O2` and `-O3` can be limited; `-O4` and `-O5` optimizations cannot be limited.
7. The `-O4` and `-O5` optimizations may also use a file in the `/tmp` directory. This is not limited by the `-qmaxmem` setting.
8. Some optimizations back off automatically before they exceed the maximum available address space, but not before they exceed the paging space available at that time, which depends on machine workload.

Restrictions

Depending on the source file being compiled, the size of subprograms in the source code, the machine configuration, and the workload on the system, setting the limit too high might fill up the paging space. In particular, a value of `-1` can fill

up the storage of even a well-equipped machine.

Related information

- “-O” on page 87
- *Optimizing your applications* in the *XL Fortran Optimization and Programming Guide*

-qmbcs

Category

Language element control

Purpose

Indicates to the compiler whether character literal constants, Hollerith constants, H edit descriptors, and character string edit descriptors can contain Multibyte Character Set (MBCS) or Unicode characters.

This option is intended for applications that must deal with data in a multibyte language, such as Japanese.

Syntax

►► -q nombcs
mbcs ◀◀

@PROCESS:

@PROCESS MBCS | NOMBCS

Defaults

-qnombcs

Usage

Each byte of a multibyte character is counted as a column.

To process the multibyte data correctly at run time, set the locale (through the **LANG** environment variable or a call to the **libc setlocale** routine) to the same value as during compilation.

To read or write Unicode data, set the locale value to **UNIVERSAL** at run time. If you do not set the locale, you might not be able to interchange data with Unicode-enabled applications.

-qmixed

Category

Input control

Purpose

This is the long form of the “-U” on page 280 option.

Syntax

►► -q nomixed
mixed ◀◀

@PROCESS:

@PROCESS MIXED | NOMIXED

Defaults

-qnomixed

-qmkshrobj

Category

Output control

@PROCESS

None.

Purpose

Creates a shared object from generated object files.

Use this option, together with the related options described later in this topic, instead of calling the linker directly to create a shared object. The advantage of using this option is that it is compatible with **-qipa** link-time optimizations (such as those performed at **-O5**).

Syntax

►► -q mkshrobj ◀◀

Defaults

By default, the output object is linked with the runtime libraries and startup routines to create an executable file.

Usage

The compiler automatically exports all global symbols from the shared object unless you specify which symbols to export by using the **--version-script** linker option. ▶ IBM Symbols that have the hidden or internal visibility attribute are not exported. IBM ◀

Specifying **-qmkshrobj** implies **-qpic**.

You can also use the following related options with **-qmkshrobj**:

-o *shared_file*

The name of the file that holds the shared file information. The default is a.out.

-e *name*

Sets the entry name for the shared executable to *name*.

-qstaticlink=xllibs

When you specify **-qstaticlink=xllibs** and **-qmkshrobj**, both options take effect. The compiler creates a shared object in which all references to the XL libraries are statically linked in.

For detailed information about using **-qmkshrobj** to create shared libraries, see “Compiling and linking a library” on page 24.

Examples

To construct the shared library `big_lib.so` from three smaller object files, enter the following command:

```
xlf -qmkshrobj -o big_lib.so lib_a.o lib_b.o lib_c.o
```

Related information

- “-e” on page 74
- “-qipa” on page 169
- “-o” on page 89
- “-qpic” on page 209

-qmoddir

Category

Output control

@PROCESS

None.

Purpose

Specifies the location for any module (.mod) or [F2008](#) submodule [F2008](#) (.smod) files that the compiler writes.

Syntax

►► -q—moddir—=*directory*◀◀

Defaults

Not applicable.

Usage

If you do not specify **-qmoddir**, the .mod or .smod files are placed in the current directory.

To read the .mod or .smod files from this directory when compiling files that reference the modules or [F2008](#) submodules [F2008](#), use the **-I** option.

Related information

- “XL Fortran output files” on page 27
- “-I” on page 80
- *Modules in the XL Fortran Language Reference*
- **F2008** *Submodules in the XL Fortran Language Reference* **F2008**

-qnoprint

Category

Listings, messages, and compiler information

@PROCESS

None.

Purpose

Prevents the compiler from creating the listing file, regardless of the settings of other listing options.

Syntax

▶▶ -qnoprint ◀◀

Defaults

Not applicable.

Usage

Specifying **-qnoprint** on the command line enables you to put other listing options in a configuration file or on **@PROCESS** directives and still prevent the listing file from being created.

A listing file is usually created when you specify any of the following options: **-qattr**, **-qlist**, **-qlistopt**, **-qphsinfo**, **-qsource**, **-qreport**, or **-qxref**. **-qnoprint** prevents the listing file from being created by changing its name to **/dev/null**, a device that discards any data that is written to it.

Related information

- “Listings, messages, and compiler information” on page 60

-qnullterm

Category

Language element control

Purpose

Appends a null character to each character constant expression that is passed as a dummy argument, making it more convenient to pass strings to C functions.

This option allows you to pass strings to C functions without having to add a null character to each string argument.

Syntax

►► -q nonullterm
nullterm ►►

@PROCESS:

@PROCESS NULLTERM | NONULLTERM

Defaults

-qnonullterm

Usage

This option affects arguments that are composed of any of the following objects:

- Basic character constants
- Concatenations of multiple character constants
- Named constants of type character
- Hollerith constants
- Binary, octal, or hexadecimal typeless constants when an interface block is available
- Any character expression composed entirely of these objects.

The result values from the **CHAR** and **ACHAR** intrinsic functions also have a null character added to them if the arguments to the intrinsic function are constant expressions.

Rules

This option does not change the length of the dummy argument, which is defined by the additional length argument that is passed as part of the XL Fortran calling convention.

Restrictions

This option affects those arguments that are passed with or without the **%REF** built-in function, but it does not affect those that are passed by value. This option does not affect character expressions in input and output statements.

Examples

Here are two calls to the same C function; one with, and one without the option:

```
@PROCESS NONULLTERM
SUBROUTINE CALL_C_1
  CHARACTER*9, PARAMETER :: HOME = "/home/luc"
! Call the libc routine mkdir() to create some directories.
  CALL mkdir ("/home/luc/testfiles\0", %val(448))
! Call the libc routine unlink() to remove a file in the home directory.
  CALL unlink (HOME // ".hushlogin" // CHAR(0))
END SUBROUTINE

@PROCESS NULLTERM
SUBROUTINE CALL_C_2
  CHARACTER*9, PARAMETER :: HOME = "/home/luc"
```

```

! With the option, there is no need to worry about the trailing null
! for each string argument.
    CALL mkdir ("/home/luc/testfiles", %val(448))
    CALL unlink (HOME // "/.hushlogin")
END SUBROUTINE
!

```

Related information

See *Passing character types between languages* in the *XL Fortran Optimization and Programming Guide*.

-qobject

Category

Error checking and debugging

Purpose

Specifies whether to produce an object file or to stop immediately after checking the syntax of the source files.

Syntax



@PROCESS:

@PROCESS OBJECT | NOOBJECT

Defaults

-qobject

Usage

When debugging a large program that takes a long time to compile, you might want to use the **-qnoobject** option. It allows you to quickly check the syntax of a program without incurring the overhead of code generation. The **.lst** file is still produced, so you can get diagnostic information to begin debugging.

After fixing any program errors, you can change back to the default (**-qobject**) to test whether the program works correctly. If it does not work correctly, compile with the **-g** option for interactive debugging.

The **-qhalt** option can override the **-qobject** option, and **-qnoobject** can override **-qhalt**.

Related information

- “Listings, messages, and compiler information” on page 60
- “Object section” on page 312
- The compiler phases in the *Getting Started with XL Fortran*.
- “-qhalt” on page 147

-qoffload

Category

Optimization and tuning

Purpose

Enables support for offloading OpenMP target regions to an NVIDIA GPU.

You can use the **TARGET** and **END TARGET** OpenMP directives to define a target region.

For **-qoffload** to take effect, you must specify the **-qsmp** option to enable the support for OpenMP target regions.

Syntax

► — -q nooffload
offload —►

Defaults

-qnooffload

Usage

To use the **-qoffload** option, you must install the CUDA Toolkit. To install the CUDA Toolkit, use the Package Manager installation. The Runfile installation is currently not supported on Power processors. For instructions about Package Manager installation, see the NVIDIA CUDA Installation Guide for Linux (<http://docs.nvidia.com/cuda/cuda-installation-guide-linux/index.html>).

You must specify the **-qoffload** option on both the compile and link steps. If you do not specify **-qoffload**, target regions run on the host, and the compiler does not generate any device code.

The compiler optimizes device code by default. You can use the **-qoffload** option with **-O2**, **-O3**, and **-Ofast**. You cannot use the **-qoffload** option with **-O4**, **-O5**, **-qipa**, **-qpdf1**, or **-qpdf2**.

Examples

To compile `myopenmpprogram.f`, enter the following command:

```
xlf -qsmp -qoffload myopenmpprogram.f -o myopenmpprogram
```

To compile `myopenmpprogram.f` into an object file and link it afterwards, enter the following commands:

```
xlf -c -qsmp -qoffload myopenmpprogram.f -o myopenmpprogram.o  
xlf -qsmp -qoffload myopenmpprogram.o -o myopenmpprogram
```

Related information

- `-qsmp`
- **TARGET** in the *XL Fortran Optimization and Programming Guide*

- Offloading computations to the NVIDIA GPUs in the *XL Fortran Optimization and Programming Guide*

-qonetrip

Category

Language element control

Purpose

This is the long form of the -1 option.

Syntax

►► -q noonetrip
onetrip ◀◀

@PROCESS:

@PROCESS ONETRIP | NOONETRIP

Defaults

-qnoonetrip

-qoptfile

Category

Compiler customization

@PROCESS directive

None.

Purpose

Specifies a file containing a list of additional command line options to be used for the compilation.

Syntax

►► -q-optfile=*filename* ◀◀

Defaults

None.

Parameters

filename

Specifies the name of the file that contains a list of additional command line options. *filename* can contain a relative path or absolute path, or it can contain no path. It is a plain text file with one or more command line options per line.

Usage

The format of the option file follows these rules:

- Specify the options you want to include in the file with the same syntax as on the command line. The option file is a whitespace-separated list of options. The following special characters indicate whitespace: \n, \v, \t. (All of these characters have the same effect.)
- A character string between a pair of single or double quotation marks are passed to the compiler as one option.
- You can include comments in the options file. Comment lines start with the # character and continue to the end of the line. The compiler ignores comments and empty lines.

When processed, the compiler removes the **-qoptfile** option from the command line, and sequentially inserts the options included in the file before the other subsequent options that you specify.

The **-qoptfile** option is also valid within an option file. The files that contain another option file are processed in a depth-first manner. The compiler avoids infinite loops by detecting and ignoring cycles in option file inclusion.

If **-qoptfile** and **-qsaveopt** are specified on the same command line, the original command line is used for **-qsaveopt**. A new line for each option file is included representing the contents of each option file. The options contained in the file are saved to the compiled object file.

Example 1

This is an example of specifying an option file.

```
$ cat options.file
# To perform optimization at -O3 level, and high-order
# loop analysis and transformations during optimization
-O3 -qhot
# To indicate that the input source program is in fixed source form
-qfixed

$ xlf95 -qlist -qoptfile=options.file -qipa test.f
```

The preceding example is equivalent to the following invocation:

```
$ xlf95 -qlist -O3 -qhot -qfixed -qipa test.f
```

Example 2

This is an example of specifying an option file that contains **-qoptfile** with a cycle.

```
$ cat options.file2
# To perform optimization at -O3 level, and high-order
# loop analysis and transformations during optimization
-O3 -qhot
# To include the -qoptfile option in the same option file
-qoptfile=options.file2
# To indicate that the input source program is in fixed source form
-qfixed
# To indicate that the source code is in free source form
-qfree

$ xlf95 -qlist -qoptfile=options.file2 -qipa test.f
```

The preceding example is equivalent to the following invocation:

```
$ xlf95 -qlist -03 -qhot -qfixed -qfree -qipa test.f
```

Example 3

This is an example of specifying an option file that contains **-qoptfile** without a cycle.

```
$ cat options.file1
-03 -qhot
-qoptfile=options.file2
-qfixed

$ cat options.file2

$ xlf95 -qoptfile=options.file1 test.f
```

The preceding example is equivalent to the following invocation:

```
$ xlf95 -03 -qhot -qfixed test.f
```

Example 4

This is an example of specifying **-qsaveopt** and **-qoptfile** on the same command line.

```
$ cat options.file3
-03
-qassert=contiguous

$ xlf95 -qsaveopt -qipa -qoptfile=options.file3 test.f -c

$ what test.o
test.o:
opt f xlf95 -qsaveopt -qipa -qoptfile=options.file3 test.f -c
optfile options.file3 -03 -qassert=contiguous
```

Related information

- “-qsaveopt” on page 224

-qoptimize

Purpose

This is the long form of the **-O** option.

Syntax

```
►► -q OPTimize[=level] NOOPTimize ◄◄
```

@PROCESS:

@PROCESS OPTimize[(*level*)] | **NOOPTimize**

Defaults

-qnooptimize

-qpath

Category

Compiler customization

Purpose

Specifies substitute path names for XL Fortran components such as the assembler, C preprocessor, and linker.

You can use this option if you want to keep multiple levels of some or all of the XL Fortran components and have the option of specifying which one you want to use.

Syntax

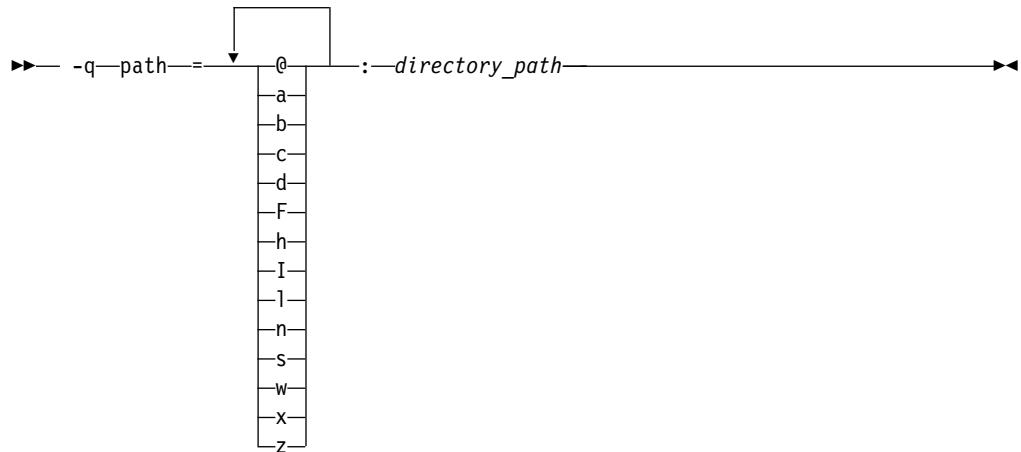

Defaults

By default, the compiler uses the paths for compiler components defined in the configuration file.

Parameters

directory_path

The path to the directory where the compiler components are located. It must be an existing directory. It can be relative or absolute.

The following table shows the correspondence between `-qpath` parameters and the component names:

Parameter	Description	Component name
> GPU @	The PTX assembler	ptxas
a	The assembler	as
b	The low-level optimizer	xlfcode
c	The compiler front end	xlfentry
d	The disassembler	dis

Parameter	Description	Component name
F	The C preprocessor	cpp
h	The array language optimizer	xlshot
I (uppercase i)	The high-level optimizer, compile step	ipa
l (lowercase L)	The linker	ld
> GPU n	The NVIDIA C compiler, which is used as a device linker	nvcc
> GPU s	The XL intermediate language (W-Code) splitter	partitioner
> GPU w	The XL intermediate language (W-Code) to NVVM-IR translator	wc2llvm
> GPU x	The NVVM-IR to PTX translator	llvm2ptx
z	The binder	bolt

Usage

The `-qpath` option overrides the `-F`, `-t`, and `-B` options.

Examples

To compile `myprogram.f` using a substitute compiler front end and linker from `/fix/FE/` and the remaining compiler components from default locations, enter the command:

```
xlf myprogram.f -qpath=c:/fix/FE
```

To compile `myprogram.f` using a substitute compiler front end from `/fix/FE`, a substitute linker from the current directory, and the remaining compiler components from default locations, enter the command:

```
xlf95 myprogram.f -qpath=c:/fix/FE -qpath=l:.
```

Related information

- “-B” on page 71
- “-t” on page 279
- *Getting Started with CUDA Fortran programming using XL Fortran*

-qpdf1, -qpdf2

Category

Optimization and tuning

@PROCESS

None.

Purpose

Tunes optimizations through *profile-directed feedback* (PDF), where results from sample program execution are used to improve optimization near conditional branches and in frequently executed code sections.

Optimizes an application for a typical usage scenario based on an analysis of how often branches are taken and blocks of code are run.

Syntax

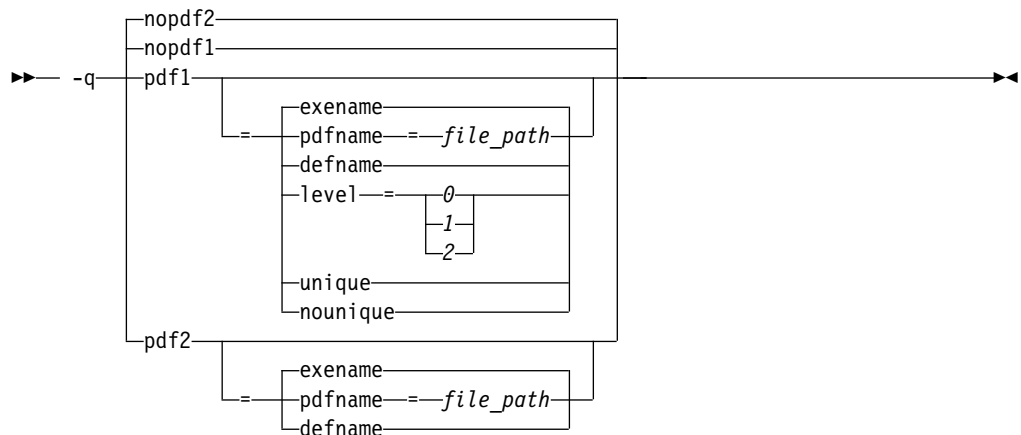

Defaults

-qnopdf1 when -qpdf1 is not specified; -qnopdf2 when -qpdf2 is not specified.

-qpdf1=exename when -qpdf1 is specified without a suboption; -qpdf2=exename when -qpdf2 is specified without a suboption.

Parameters

exename

Names the generated PDF file as `.<output_name>_pdf`, where `<output_name>` is the name of the output file that is generated when you compile your program with `-qpdf1`.

pdfname=*file_path*

Specifies the directories and names for the PDF files and any existing PDF map files. If the `PDFDIR` environment variable is set, the compiler places the PDF and PDF map files in the directory that is specified by `PDFDIR`; otherwise, the compiler places these files in the current working directory. If the `PDFDIR` environment variable is set but the specified directory does not exist, the compiler issues a warning message. The name of the PDF map file follows the name of the PDF file if the `-qpdf1=unique` option is not specified. For example, if you specify the `-qpdf1=pdfname=/home/joe/func` option, the generated PDF file is called `func`, and the PDF map file is called `func_map`. Both of the files are placed in the `/home/joe` directory. You can use the `pdfname` suboption to do simultaneous runs of multiple executable applications by using the same directory. This approach is especially useful when you are tuning dynamic libraries with PDF.

defname

Names the generated PDF file as `._pdf`.

level=0 | 1 | 2

Specifies different levels of profiling information to be generated by the resulting application. The following table shows the type of profiling information supported on each level. The plus sign (+) indicates that the profiling type is supported.

Table 19. Profiling type supported on each -qpdf1 level

Profiling type	Level		
	0	1	2
Block-counter profiling	+	+	+
Call-counter profiling	+	+	+
Value profiling		+	+
Cache-miss profiling			+

-qpdf1=level=1 is the default level. It is equivalent to **-qpdf1**. Higher PDF levels profile more optimization opportunities but have a larger overhead.

Notes:

- Only one application that is compiled with the **-qpdf1=level=2** option can be run at a time on a particular processor.
- Cache-miss profiling information has several levels. Accordingly, if you want to gather different levels of cache-miss profiling information, set the PDF_PM_EVENT environment variable to L1MISS, L2MISS, or L3MISS (if applicable). Only one level of cache-miss profiling information can be instrumented at a time. L2 cache-miss profiling is the default level.
- If you want to bind your application to a specified processor for cache-miss profiling, set the PDF_BIND_PROCESSOR environment variable equal to the processor number.

unique | nunique

You can use the **-qpdf1=unique** option to avoid locking a single PDF file when multiple processes are writing to the same PDF file in the PDF training step. This option specifies whether a unique PDF file is created for each process during run time. The PDF file name is `<pdf_file_name>.<pid>`.

`<pdf_file_name>` is one of the following names:

- `.<output_name>_pdf` by default.
- The name that is specified by **pdfname** when this suboption is in effect.
- `._pdf` when the **defname** suboption takes effect.

`<pid>` is the ID of the running process in the PDF training step. For example, if you specify the **-qpdf1=unique:pdfname=abc** option, and there are two processes for PDF training with the IDs 12345678 and 87654321, two PDF files `abc.12345678` and `abc.87654321` are generated.

Note: When **-qpdf1=unique** is specified, multiple PDF files with process IDs as suffixes are generated. You must use the **mergepdf** program to merge all these PDF files into one after the PDF training step.

Usage

The PDF process consists of the following three steps:

1. Compile your program with the **-qpdf1** option and a minimum optimization level of **-O2**. By default, a PDF map file that is named `.<output_name>_pdf_map` and a resulting application are generated.

2. Run the resulting application with a typical data set. Profiling information is written to a PDF file named `.<output_name>_pdf` by default. This step is called the PDF training step.
3. Recompile and link or relink the program with the **-qpdf2** option and the optimization level used with the **-qpdf1** option. The **-qpdf2** process fine-tunes the optimizations according to the profiling information collected when the resulting application is run.

Predefined macros

None.

Examples

Example 1

The example uses the **-qpdf1=level=0** option to reduce possible runtime instrumentation overhead.

1. Compile all the files with **-qpdf1=level=0**.

```
xlf -qpdf1=level=0 -O3 file1.f file2.f file3.f
```
2. Run with one set of input data.

```
./a.out < sample.data
```
3. Recompile all the files with **-qpdf2**.

```
xlf -qpdf2 -O3 file1.f file2.f file3.f
```

If the sample data is typical, the program can run faster than without the PDF process.

Example 2

The following example uses the **-qpdf1=level=1** option.

1. Compile all the files with **-qpdf1**.

```
xlf -qpdf1 -O3 file1.f file2.f file3.f
```
2. Run with one set of input data.

```
./a.out < sample.data
```
3. Recompile all the files with **-qpdf2**.

```
xlf -qpdf2 -O3 file1.f file2.f file3.f
```

If the sample data is typical, the program can now run faster than without the PDF process.

Example 3

The following example uses the **-qpdf1=level=2** option to gather cache-miss profiling information.

1. Compile all the files with **-qpdf1=level=2**.

```
xlf -qpdf1=level=2 -O3 file1.f file2.f file3.f
```
2. Set `PM_EVENT=L2MISS` to gather L2 cache-miss profiling information.

```
export PDF_PM_EVENT=L2MISS
```
3. Run with one set of input data.

```
./a.out < sample.data
```
4. Recompile all the files with **-qpdf2**.

```
xlf -qpdf2 -O3 file1.f file2.f file3.f
```

If the sample data is typical, the program can now run faster than without the PDF process.

Example 4

This example demonstrates the usage of the **-qpdf[1|2]=exename** option.

1. Compile all the files with **-qpdf1=exename**.

```
xlf -qpdf1=exename -O3 -o final file1.f file2.f file3.f
```
2. Run executable with sample input data.

```
./final < typical.data
```
3. List the content of the directory.

```
>ls -lrta
```

```
-rw-r--r-- 1 user staff 50 Dec 05 13:18 file1.f  
-rw-r--r-- 1 user staff 50 Dec 05 13:18 file2.f  
-rw-r--r-- 1 user staff 50 Dec 05 13:18 file3.f  
-rwxr-xr-x 1 user staff 12243 Dec 05 17:00 final  
-rwxr-Sr-- 1 user staff 762 Dec 05 17:03 .final_pdf
```
4. Recompile all the files with **-qpdf2=exename**.

```
xlf -qpdf2=exename -O3 -o final file1.f file2.f file3.f
```

The program is now optimized by using PDF information.

Example 5

The following example demonstrates the usage of the **-qpdf[1|2]=pdfname** option.

1. Compile all the files with **-qpdf1=pdfname**. The static profiling information is recorded in a file that is named `final_map`.

```
xlf -qpdf1=pdfname=final -O3 file1.f file2.f file3.f
```
2. Run the executable file with sample input data. The profiling information is recorded in a file that is named `final`.

```
./a.out < typical.data
```
3. List the content of the directory.

```
>ls -lrta
```

```
-rw-r--r-- 1 user staff 50 Dec 05 13:18 file1.f  
-rw-r--r-- 1 user staff 50 Dec 05 13:18 file2.f  
-rw-r--r-- 1 user staff 50 Dec 05 13:18 file3.f  
-rwxr-xr-x 1 user staff 12243 Dec 05 18:30 a.out  
-rwxr-Sr-- 1 user staff 762 Dec 05 18:32 final
```
4. Recompile all the files with **-qpdf2=pdfname**.

```
xlf -qpdf2=pdfname=final -O3 file1.f file2.f file3.f
```

The program is now optimized by using PDF information.

Example 6

The following example demonstrates the use of the `PDF_BIND_PROCESSOR` environment variable.

1. Compile all the files with **-qpdf1=level=1**.

```
xlf -qpdf1=level=1 -O3 file1.f file2.f file3.f
```
2. Set `PDF_BIND_PROCESSOR` environment variable so that all processes for this executable file are run on processor 1.

```
export PDF_BIND_PROCESSOR=1
```
3. Run executable with sample input data.

```
./a.out < sample.data
```

4. Recompile all the files with **-qpdf2**.

```
xlf -qpdf2 -O3 file1.f file2.f file3.f
```

If the sample data is typical, the program can now run faster than without the PDF process.

Related information

- “-qshowpdf” on page 227
- “-qipa” on page 169
- -qprefetch
- “-qreport” on page 220
- “cleanpdf” on page 287
- “mergepdf” on page 288
- “showpdf” on page 289
- “XL Fortran input files” on page 26
- “XL Fortran output files” on page 27
- “Profile-directed feedback” in the *XL Fortran Optimization and Programming Guide*
- Correct settings for environment variables

-qphsinfo

Category

Listings, messages, and compiler information

Purpose

Reports the time taken in each compilation phase to standard output.

Syntax

```
➤ -q nophsinfo  
phsinfo ➤
```

@PROCESS:

@PROCESS PHSINFO | NOPHSINFO

Defaults

-qnophsinfo

Usage

The output takes the form *number1/number2* for each phase where *number1* represents the CPU time used by the compiler and *number2* represents the total of the compile time and the time that the CPU spends handling system calls.

The time reported by -qphsinfo is in seconds.

Examples

To compile **app.f**, which consists of 3 compilation units, and report the time taken for each phase of the compilation, enter:

```
xlf90 app.f -qphsinfo
```

The output looks similar to:

```
FORTRAN phase 1 ftphas1      TIME = 0.000 / 0.000
** m_module   === End of Compilation 1 ===
FORTRAN phase 1 ftphas1      TIME = 0.000 / 0.000
** testassign === End of Compilation 2 ===
FORTRAN phase 1 ftphas1      TIME = 0.000 / 0.010
** dataassign  === End of Compilation 3 ===
HOT           - Phase Ends;  0.000/ 0.000
HOT           - Phase Ends;  0.000/ 0.000
HOT           - Phase Ends;  0.000/ 0.000
W-TRANS       - Phase Ends;  0.000/ 0.010
OPTIMIZ       - Phase Ends;  0.000/ 0.000
REGALLO       - Phase Ends;  0.000/ 0.000
AS            - Phase Ends;  0.000/ 0.000
W-TRANS       - Phase Ends;  0.000/ 0.000
OPTIMIZ       - Phase Ends;  0.000/ 0.000
REGALLO       - Phase Ends;  0.000/ 0.000
AS            - Phase Ends;  0.000/ 0.000
W-TRANS       - Phase Ends;  0.000/ 0.000
OPTIMIZ       - Phase Ends;  0.000/ 0.000
REGALLO       - Phase Ends;  0.000/ 0.000
AS            - Phase Ends;  0.000/ 0.000
1501-510      Compilation successful for file app.f.
```

Each phase is invoked three times, corresponding to each compilation unit. FORTRAN represents front-end parsing and semantic analysis, HOT loop transformations, W-TRANS intermediate language translation, OPTIMIZ high-level optimization, REGALLO register allocation and low-level optimization, and AS final assembly.

Compile **app.f** at the **-O4** optimization level with **-qphsinfo** specified:

```
xlf90 myprogram.f -qphsinfo -O4
```

The following output results:

```
FORTRAN phase 1 ftphas1      TIME = 0.010 / 0.020
** m_module   === End of Compilation 1 ===
FORTRAN phase 1 ftphas1      TIME = 0.000 / 0.000
** testassign === End of Compilation 2 ===
FORTRAN phase 1 ftphas1      TIME = 0.000 / 0.000
** dataassign  === End of Compilation 3 ===
HOT           - Phase Ends;  0.000/ 0.000
HOT           - Phase Ends;  0.000/ 0.000
HOT           - Phase Ends;  0.000/ 0.000
IPA           - Phase Ends;  0.080/ 0.100
1501-510      Compilation successful for file app.f.
IPA           - Phase Ends;  0.050/ 0.070
W-TRANS       - Phase Ends;  0.010/ 0.030
OPTIMIZ       - Phase Ends;  0.020/ 0.020
REGALLO       - Phase Ends;  0.040/ 0.040
AS            - Phase Ends;  0.000/ 0.000
```

Note that during the IPA (interprocedural analysis) optimization phases, the program has resulted in one compilation unit; that is, all procedures have been inlined.

Related information

.The compiler phases in the *Getting Started with XL Fortran*

-qpic

Category

Object code control

@PROCESS

None.

Purpose

Generates position-independent code required for use in shared libraries.

Syntax

►► — -q —

nopic
pic

 —————►►

Defaults

- -qnopic

Usage

When **-qpic** is in effect, the compiler generates two instructions for each TOC access to enlarge the accessing range. This helps avoid TOC overflow conditions when the Table of Contents is larger than 64 Kb.

You must specify **-qpic** when you build shared libraries.

When you specify **-qpic -qtls**, thread local storage (TLS) symbols are not affected by **-qpic**.

You can use different TOC access options for different compilation units in an application.

-qport

Category

Portability and migration

Purpose

Provides options to accommodate other Fortran language extensions when porting programs to XL Fortran.

A particular **-qport** suboption will always function independently of other **-qport** and compiler options.

Syntax

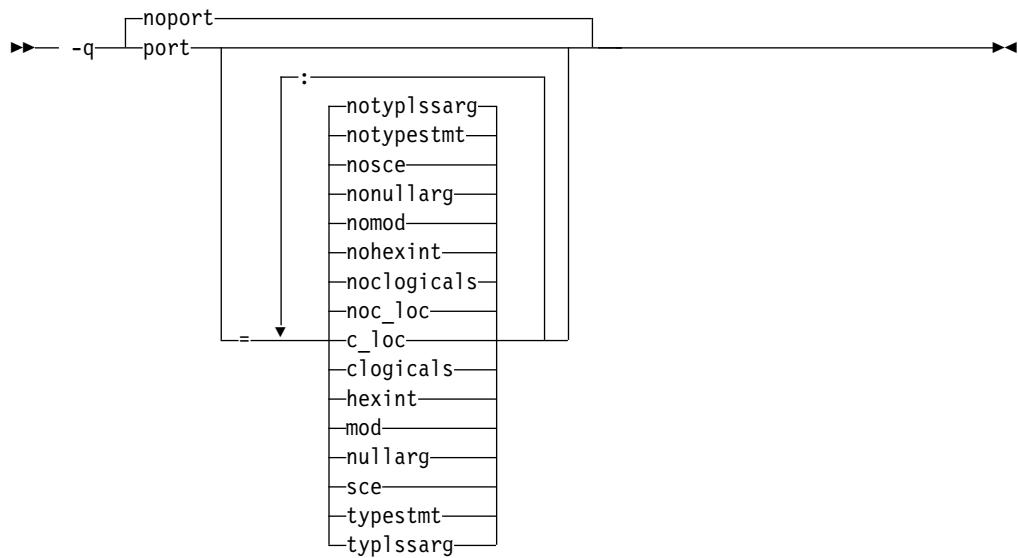

@PROCESS:

@PROCESS PORT[(*suboptions*)] | **NOPORT**

Defaults

-qnoport

Parameters

c_loc | **noc_loc**

When **c_loc** is in effect, the C_LOC function from the ISO_C_BINDING module can accept arguments that have neither the **POINTER** nor the **TARGET** attribute.

If the actual argument that corresponds to the dummy argument of the C_LOC function does not have the **POINTER** or the **TARGET** attribute, **-qport=c_loc** applies the **TARGET** attribute to the actual argument in the compilation unit that contains the call to the C_LOC function.

Note: To ensure portability of your code, specify the **TARGET** attribute instead of using this option.

clogicals | **noclogicals**

When **clogicals** is in effect, the compiler treats all non-zero integers that are used in logical expressions as TRUE. You must specify **-qintlog** for **-qport=clogicals** to take effect.

The **-qport=clogicals** option is useful when porting applications from other Fortran compilers that expect this behavior. However, it is unsafe to mix programs that use different settings for non-zero integers if they share or pass logical data between them. Data files already written with the default **-qintlog** setting will produce unexpected behavior if read with the **-qport=clogicals** option active.

hexint | **nohexint**

When **hexint** is in effect, typeless constant hexadecimal strings are converted to integers when passed as an actual argument to the **INT** intrinsic function. Typeless constant hexadecimal strings not passed as actual arguments to **INT** remain unaffected.

mod | nomod

Specifying **mod** relaxes existing constraints on the **MOD** intrinsic function, allowing two arguments of the same data type to be of different kind type parameters. The result will be of the same basic type as the argument, but with the larger kind type parameter value.

nullarg | nonnullarg

For an external or internal procedure reference, specifying **nullarg** causes the compiler to treat an empty argument, which is delimited by a left parenthesis and a comma, two commas, or a comma and a right parenthesis, as a null argument. This suboption has no effect if the argument list is empty.

Examples of empty arguments are:

```
call foo(,,z)
```

```
call foo(x,,z)
```

```
call foo(x,y,)
```

The following program includes a null argument.

Fortran program:

```
program nularg
real(4) res/0.0/
integer(4) rc
integer(4), external :: add
rc = add(%val(2), res, 3.14, 2.18,) ! The last argument is a
                                ! null argument.
if (rc == 0) then
print *, "res = ", res
else
print *, "number of arguments is invalid."
endif
end program
```

C program:

```
int add(int a, float *res, float *b, float *c, float *d)
{
    int ret = 0;
    if (a == 2)
        *res = *b + *c;
    else if (a == 3)
        *res = (*b + *c + *d);
    else
        ret = 1;
    return (ret);
}
```

sce | nosce

By default, the compiler performs short circuit evaluation in selected logical expressions using XL Fortran rules. Specifying **sce** allows the compiler to use non-XL Fortran rules. The compiler will perform short circuit evaluation if the current rules allow it.

typestmt | notypestmt

The **TYPE** statement, which behaves in a manner similar to the **PRINT** statement, is supported whenever **typestmt** is specified.

typlessarg | notyplessarg

Converts all typeless constants to default integers if the constants are actual arguments to an intrinsic procedure whose associated dummy

arguments are of integer type. Typeless actual arguments associated with dummy arguments of noninteger type remain unaffected by this option.

Using this option may cause some intrinsic procedures to become mismatched in kinds. Specify `-qxlf77=intarg` to convert the kind to that of the longest argument.

Related information

- “-qintlog” on page 166
- “-qxlf77” on page 266
- See the section on the *INT* and *MOD* intrinsic functions in the *XL Fortran Language Reference* for further information.

-qposition

Category

Language element control

Purpose

Positions the file pointer at the end of the file when data is written after an **OPEN** statement with no **POSITION=** specifier and the corresponding **STATUS=** value (**OLD** or **UNKNOWN**) is specified.

The position becomes **APPEND** when the first I/O operation moves the file pointer if that I/O operation is a **WRITE** or **PRINT** statement. If it is a **BACKSPACE**, **ENDFILE**, **READ**, or **REWIND** statement instead, the position is **REWIND**.

Syntax



►► -q-position=
└─ appendold ─┘
└─ appendunknown ─┘

@PROCESS:

@PROCESS POSITION({APPENDOLD | APPENDUNKNOWN} ...)

Defaults

The default setting depends on the I/O specifiers in the **OPEN** statement and on the compiler invocation command:

- **-qposition=appendold** for the **xlf** and **xlf_r** commands when they are used to compile the **.f**, **.F**, **.f77**, or **.F77** files
- **-qposition=appendold** for the **f77** and **fort77** commands
- The defined Fortran 90, Fortran 95, Fortran 2003, and Fortran 2008 behaviors for the **xlf90**, **f90**, **xlf90_r**, **xlf95**, **f95**, **xlf95_r**, **xlf2003**, **f2003**, **xlf2003_r**, **xlf2008**, **f2008**, and **xlf2008_r** commands
-  The defined Fortran 2008 behaviors for the **xlculf** command 

Examples

In the following example, **OPEN** statements that do not specify a **POSITION=** specifier, but specify **STATUS='old'** will open the file as if **POSITION='append'** was specified.

```
xlf95 -qposition=appendold opens_old_files.f
```

In the following example, **OPEN** statements that do not specify a **POSITION=** specifier, but specify **STATUS='unknown'** will open the file as if **POSITION='append'** was specified.

```
xlf95 -qposition=appendunknown opens_unknown_files.f
```

In the following example, **OPEN** statements that do not specify a **POSITION=** specifier, but specify either **STATUS='old'** or **STATUS='unknown'** will open the file as if **POSITION='append'** was specified.

```
xlf95 -qposition=appendold:appendunknown opens_many_files.f
```

Related information

- *File positioning* in the *XL Fortran Optimization and Programming Guide*
- *OPEN statement* in the *XL Fortran Language Reference*

-qppsuborigarg

Category

Input control

@PROCESS

None.

Purpose

Instructs the C preprocessor to substitute original macro arguments before further macro expansion.

Syntax

```
➔ -WF, -q [noppsuborigarg] ppsuborigarg ➔
```

Defaults

- -WF, -qnoppsuborigarg

Usage

-qppsuborigarg is a C preprocessor option, and must therefore be specified using the **-WF** option.

Examples

Consider the following sample code, x.F:

```
#define PRINT_COMP(a) PRINT_4(SPLIT_COMP(a))
#define SPLIT_COMP(a) "Real:", real(a), "Imag:", imag(a)
#define PRINT_4(list) PRINT_LIST(list)
#define PRINT_LIST(list) print *, list
```

```
complex a
a = (3.5, -3.5)
PRINT_COMP(a)
end
```

If this code is compiled with **-qnoptionsuborigarg**, the C preprocessor reports an error because the parameter "list" in the function-like macro PRINT_4 is the expanded substitution text of the macro SPLIT_COMP(a). The C preprocessor therefore complains because PRINT_LIST is being called with four arguments but only expects one.

```
> xlf95 x.F -d
"x.F", line 8.1: 1506-215 (E) Too many arguments specified for macro PRINT_LIST.
** _main    === End of Compilation 1 ===
1501-510  Compilation successful for file x.F.
> cat Fx.f
```

```
complex a
a = (3.5, -3.5)
print *, "Real:"
end
```

When the code is compiled with **-qppsuborigarg**, the C preprocessor uses the text "SPLIT_COMP(a)" rather than the expanded substitution text of SPLIT_COMP(a) as the argument to the function-like macro PRINT_LIST. Only after the macro PRINT_LIST has been expanded, does the C preprocessor proceed to expand the macro "SPLIT_COMP(a)". As a result, the macro PRINT_LIST only receives the expected single argument "SPLIT_COMP(a)" rather than the four arguments.

```
> xlf95 x.F -d -WF,-qppsuborigarg
** _main    === End of Compilation 1 ===
1501-510  Compilation successful for file x.F.
> cat Fx.f
```

```
complex a
a = (3.5, -3.5)
print *, "Real:", real(a), "Imag:", imag(a)
end
```

Related information

- "-W, -X" on page 283
- "-qfpp" on page 137
- "Passing Fortran files through the C preprocessor" on page 32

-qprefetch

Category

Optimization and tuning

@PROCESS

None.

Purpose

Inserts prefetch instructions automatically where there are opportunities to improve code performance.

When **-qprefetch** is in effect, the compiler may insert prefetch instructions in compiled code. When **-qnoprefetch** is in effect, prefetch instructions are not inserted in compiled code.

Syntax

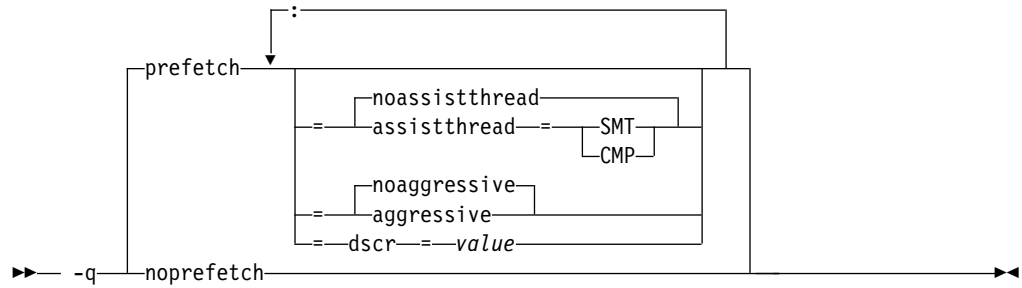

Defaults

-qprefetch=noassistthread:noaggressive:dscr=0

Parameters

assistthread | **noassistthread**

When you work with applications that generate a high cache-miss rate, you can use **-qprefetch=assistthread** to exploit assist threads for data prefetching. This suboption guides the compiler to exploit assist threads at optimization level **-O3 -qhot** or higher. If you do not specify **-qprefetch=assistthread**, **-qprefetch=noassistthread** is implied.

CMP

For systems based on the chip multi-processor architecture (CMP), you can use **-qprefetch=assistthread=cmp**.

SMT

For systems based on the simultaneous multi-threading architecture (SMT), you can use **-qprefetch=assistthread=smt**.

Note: If you do not specify either CMP or SMT, the compiler uses the default setting based on your system architecture.

aggressive | **noaggressive**

This suboption guides the compiler to generate aggressive data prefetching at optimization level **-O3** or higher. If you do not specify **aggressive**, **-qprefetch=noaggressive** is implied.

dscr

You can specify a value for the dscr suboption to improve the runtime performance of your applications. The compiler sets the Data Stream Control Register (DSCR) to the specified dscr value to control the hardware prefetch engine. The value is valid when **-qarch=pwr8** is in effect and the optimization level is **-O2** or greater. The default value of dscr is 0.

value

The value that you specify for dscr must be 0 or greater, and representable as a 64-bit unsigned integer. Otherwise, the compiler issues a warning message and sets dscr to 0. The compiler accepts both decimal and hexadecimal numbers, and a hexadecimal number requires the prefix of 0x. The value range depends on your system architecture. See the product information about the POWER Architecture for details. If you specify multiple dscr values, the last one takes effect.

Usage

The **-qnoprefetch** option does not prevent built-in functions such as **__prefetch_by_stream** from generating prefetch instructions.

When you run **-qprefetch=assistthread**, the compiler uses the delinquent load information to perform analysis and generates prefetching assist threads. The delinquent load information can either be provided through the built-in **__mem_delay** function (const void *delinquent_load_address, const unsigned int delay_cycles), or gathered from dynamic profiling using **-qpdf1=level=2**.

When you use **-qpdf** to call **-qprefetch=assistthread**, you must use the traditional two-step PDF invocation:

1. Run **-qpdf1=level=2**
2. Run **-qpdf2 -qprefetch=assistthread**

Example

```
DO i = 1, 1000

!IBM* MEM_DELAY(x(i), 10)
x(i) = x(i) + 1

END DO
```

Examples

```
DO I = 1, 1000

!IBM* MEM_DELAY(X(I), 10)

X(I) = X(I) + 1

END DO
```

Related information

- **-qarch**
- “-qhot” on page 149
- “-qpdf1, -qpdf2” on page 202
- “-qreport” on page 220
- **MEM_DELAY** section in the *XL Fortran Language Reference*

-qqcount

Category

Language element control

Purpose

Accepts the **Q** character-count edit descriptor (**Q**) as well as the extended-precision **Q** edit descriptor (**Qw.d**).

Syntax

→ -q noqcount qcount →

@PROCESS:

@PROCESS QCOUNT | NOQCOUNT

Defaults

With **-qnoqcount**, all **Q** edit descriptors are interpreted as the extended-precision **Q** edit descriptor.

Usage

The compiler interprets a **Q** edit descriptor as one or the other depending on its syntax and issues a warning if it cannot determine which one is specified.

Related information

- *Q (Character Count) Editing in the XL Fortran Language Reference*

-qrealsize

Category

Floating-point and integer control

Purpose

Sets the default size of **REAL**, **DOUBLE PRECISION**, **COMPLEX**, and **DOUBLE COMPLEX** values.

This option is intended for maintaining compatibility with code that is written for other systems. You may find it a useful alternative to the **-qautodbl** option in some situations.

Syntax

►► -qrealsize=

4
8

►►

@PROCESS:

@PROCESS REALSIZE(*bytes*)

Defaults

-qrealsize=4

Parameters

The allowed values for *bytes* are as follows:

- 4
- 8

Usage

This option is intended to allow you to port programs unchanged from systems that have different default sizes for data. For example, you might need **-qrealsize=8** for programs that are written for a CRAY computer.

`-qautodbl` is related to `-qrealsize`, although you cannot combine these options. When the `-qautodbl` option turns on automatic doubling, padding, or both, the `-qrealsize` option has no effect.

Setting `-qrealsize` to 8 overrides the setting of the `-qdpc` option.

In addition to type `REAL`, `-qrealsize` also works for type `vector(real)`.

Results

The option affects the sizes² of constants, variables, derived type components, and functions (which include intrinsic functions) for which no kind type parameter is specified. Objects that are declared with a kind type parameter or length, such as `REAL(4)` or `COMPLEX*16`, are not affected.

This option determines the sizes of affected objects as follows:

Data Object	REALSIZE(4) in Effect	REALSIZE(8) in Effect
1.2	REAL(4)	REAL(8)
1.2e0	REAL(4)	REAL(8)
1.2d0	REAL(8)	REAL(16)
1.2q0	REAL(16)	REAL(16)
REAL	REAL(4)	REAL(8)
DOUBLE PRECISION	REAL(8)	REAL(16)
COMPLEX	COMPLEX(4)	COMPLEX(8)
DOUBLE COMPLEX	COMPLEX(8)	COMPLEX(16)

Similar rules apply to intrinsic functions:

- If an intrinsic function has no type declaration, its argument and return types may be changed by the `-qrealsize` setting.
- Any type declaration for an intrinsic function must agree with the default size of the return value.

Examples

This example shows how changing the `-qrealsize` setting transforms some typical entities:

```
@PROCESS REALSIZE(8)
    REAL R                ! treated as a real(8)
    REAL(8) R8            ! treated as a real(8)
    VECTOR(REAL)          ! treated as a vector(real(8))
    VECTOR(REAL(4))       ! treated as a vector(real(4))
    DOUBLE PRECISION DP   ! treated as a real(16)
    DOUBLE COMPLEX DC     ! treated as a complex(16)
    COMPLEX(4) C          ! treated as a complex(4)
    PRINT *,DSIN(DP)      ! treated as qsin(real(16))
! Note: we cannot get dsin(r8) because dsin is being treated as qsin.
END
```

Specifying `-qrealsize=8` affects intrinsic functions, such as `DABS`, as follows:

```
INTRINSIC DABS           ! Argument and return type become REAL(16).
DOUBLE PRECISION DABS    ! OK, because DOUBLE PRECISION = REAL(16)
                        ! with -qrealsize=8 in effect.
REAL(16) DABS            ! OK, the declaration agrees with the option setting.
REAL(8) DABS             ! The declaration does not agree with the option
                        ! setting and is ignored.
```

2. In Fortran 90/95 terminology, these values are referred to as *kind type parameters*.

Related information

- “-qintsize” on page 167 is a similar option that affects integer and logical objects.
- “-qautodbl” on page 101
- *Type declaration: type parameters and specifiers* in the *XL Fortran Language Reference*

-qrecur

Purpose

Specifies whether external subprograms may be called recursively.

Not recommended.

Syntax

►► -q norecur
recur ◄◄

@PROCESS:

@PROCESS RECUR | NORECUR

Defaults

-qnorecur

Usage

For new programs, use the **RECURSIVE** keyword, which provides a standards-conforming way of using recursive procedures.

If you specify the **-qrecur** option, the compiler must assume that any procedure could be recursive. Code generation for recursive procedures may be less efficient. With the **RECURSIVE** keyword, you can specify exactly which procedures are recursive.

When you use the following commands to compile programs that contain recursive calls, specify **-qnosave** to make the default storage class automatic:

- For `.f`, `.F`, `.f77` and `.F77` files: **xl**f and **xl**f_r
- For any source files: **f77** and **fort77**

Examples

! The following RECUR recursive function:

```
@process recur
function factorial (n)
integer factorial
if (n .eq. 0) then
  factorial = 1
else
  factorial = n * factorial (n-1)
end if
end function factorial
```

! can be rewritten to use F90/F95 RECURSIVE/RESULT features:

```
recursive function factorial (n) result (res)
integer res
```

```

if (n .eq. 0) then
  res = 1
else
  res = n * factorial (n-1)
end if
end function factorial

```

-qreport

Category

Listings, messages, and compiler information

Purpose

Produces listing files that show how sections of code have been optimized.

A listing file is generated with a .lst suffix for each source file that is listed on the command line. When you specify **-qreport** with an option that enables automatic parallelization or vectorization, the listing file shows a pseudo-Fortran code listing and a summary of how program loops are parallelized or optimized. The report also includes diagnostic information about why specific loops cannot be parallelized or vectorized. For example, when **-qreport** is specified with **-qsimd**, messages are provided to identify non-stride-one references that prevent loop vectorization.

The compiler also reports the number of streams created for a given loop, which include both load and store streams. This information is included in the Loop Transformation section of the listing file. You can use this information to understand your application code and to tune your code for better performance. For example, you can distribute a loop which has more streams than the number supported by the underlying architecture. The POWER8 processors support both load and store stream prefetch.

Syntax

Option:

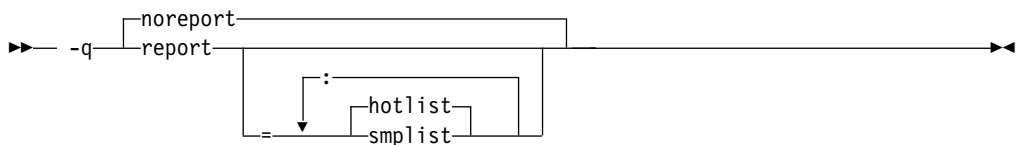

@PROCESS:

@PROCESS REPORT[({SMPLIST |HOTLIST}...)] | NOREPORT

Defaults

-qnoreport

Parameters

smplist | hotlist

When -qreport=smplist is in effect, produces a pseudo-Fortran listing that shows how the program is parallelized. This listing is produced before

loop and other optimizations are performed. It includes messages that point out places in the program that can be modified to be more efficient. This report is only produced if **-qsmp** is in effect.

When **-qreport=hotlist** is in effect, produces a pseudo-Fortran listing that shows how loops are transformed, to assist you in tuning the performance of all loops. This report is only produced if **-qhot** is in effect.

In addition, if you specify the **-qreport=hotlist** option when **-qsmp** is in effect, a pseudo-Fortran listing will be produced that shows the calls to the SMP runtime library and the procedures created for parallel constructs.

Specifying **-qreport** with no suboptions is equivalent to **-qreport=hotlist**.

Usage

To generate a loop transformation listing, you must specify **-qreport** with one of the following options:

- **-qhot**
- **-qsmp**
- **-O3** or higher

You can specify both **-qreport** and **-qpdf2** to generate information in your listing file to help you tune your program. This information is written to the PDF Report section.

To generate a parallel transformation listing or parallel performance messages, you must specify **-qreport** with one of the following options:

- **-qsmp**
- **-O5**
- **-qipa=level=2**

To generate data reorganization information, specify **-qreport** with the optimization level **-qipa=level=2** or **-O5**. Reorganizations include common block splitting, array splitting, array transposing, memory allocation merging, array interleaving, and array coalescing.

To generate information about data prefetch insertion locations, specify **-qreport** with the optimization level of **-qhot** or any other option that implies **-qhot**. This information appears in the LOOP TRANSFORMATION SECTION of the listing file. In addition, when you use **-qprefetch=assistthread** to generate prefetching assist threads, the message: Assist thread for data prefetching was generated also appears in the LOOP TRANSFORMATION SECTION of the listing file.

To generate a list of aggressive loop transformations and parallelization performed on loop nests in the LOOP TRANSFORMATION SECTION of the listing file, use the optimization level of **-qhot=level=2** and **-qsmp** together with **-qreport**.

The pseudo-Fortran code listing is not intended to be compilable. Do not include any of the pseudo-Fortran code in your program, and do not explicitly call any of the internal routines whose names may appear in the pseudo-Fortran code listing.

Examples

To compile `myprogram.f` so the compiler listing includes a report showing how loops are optimized, enter the following command:

```
xlf -qhot -O3 -qreport myprogram.f
```

To compile `myprogram.f` so the compiler listing also includes a report showing how parallelized loops are transformed, enter the following command:

```
xlf_r -qhot -qsmp -qreport=smlist myprogram.f
```

Related information

- “-qhot” on page 149
- “-qsimd” on page 229
- “-qipa” on page 169
- “-qpdf1, -qpdf2” on page 202
- “-qsmp” on page 232

-qsaa

Category

Language element control

Purpose

Checks for conformance to the SAA FORTRAN language definition. It identifies nonconforming source code and also options that allow such nonconformances.

Syntax

```
→ -q [nosaa] [saa] →
```

@PROCESS:

@PROCESS SAA | NOSAA

Defaults

-qnosaa

Usage

The **-qflag** option can override this option.

Use the **-qlanglvl** option to check your code for conformance to international standards.

Results

Warnings have a prefix of **(L)**, indicating a problem with the language level.

Related information

- “-qflag” on page 132
- “-qlanglvl” on page 175

-qsave

Category

Language element control

Purpose

Specifies the default storage class for local variables.

Syntax

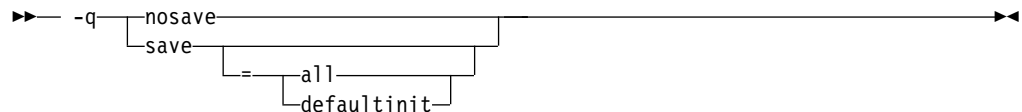

@PROCESS:

```
@PROCESS SAVE[({ALL | DEFAULTINIT})] | NOSAVE
```

Defaults

The default for this option depends on the invocation command used:

- When **xl**f is used to compile the .f, .F, .f77, or .F77 files, the default is **-qsave=all**.
- For the **f77** and **fort77** invocation commands, the default is **-qsave=all**.
- For all the other invocation commands, the default is **-qnosave**.

Parameters

The **-qsave** suboptions include:

all

The default storage class is **STATIC**.

defaultinit

The default storage class is **STATIC** for variables of derived type that have default initialization specified, and **AUTOMATIC** otherwise.

The **all** and **defaultinit** suboptions are mutually exclusive.

Usage

The **-qnosave** option sets the default storage class to **AUTOMATIC**. This usage is usually necessary for multithreaded applications and subprograms that are compiled with the **-qrecur** option.

You can specify the **-qsave** option to duplicate the behavior of FORTRAN 77 programs. The **xl**f, **f77** and **fort77** commands have **-qsave** listed as a default option in the configuration file to preserve the previous behavior. The default configuration file path is `/opt/ibm/xlf/15.1.5/etc/xlf.cfg`

Examples

The following example illustrates the impact of the **-qsave** option on derived data type:

```

PROGRAM P
  CALL SUB
  CALL SUB
END PROGRAM P

SUBROUTINE SUB
  LOGICAL, SAVE :: FIRST_TIME = .TRUE.
  STRUCTURE /S/
    INTEGER I/17/
  END STRUCTURE
  RECORD /S/ LOCAL_STRUCT
  INTEGER LOCAL_VAR

  IF (FIRST_TIME) THEN
    LOCAL_STRUCT.I = 13
    LOCAL_VAR = 19
    FIRST_TIME = .FALSE.
  ELSE
    ! Prints " 13" if compiled with -qsave or -qsave=all
    ! Prints " 13" if compiled with -qsave=defaultinit
    ! Prints " 17" if compiled with -qnosave
    PRINT *, LOCAL_STRUCT
    ! Prints " 19" if compiled with -qsave or -qsave=all
    ! Value of LOCAL_VAR is undefined otherwise
    PRINT *, LOCAL_VAR
  END IF
END SUBROUTINE SUB

```

Related information

- “-qrecur” on page 219
- See *Storage classes for variables* in the *XL Fortran Language Reference* for information on how this option affects the storage class of variables.

-qsaveopt

Category

Object code control

@PROCESS

None.

Purpose

Saves the command-line options used for compiling a source file, the user's configuration file name and the options specified in the configuration files, the version and level of each compiler component invoked during compilation, and other information to the corresponding object file.

Syntax

►► -q nosaveopt saveopt ◄◄

Defaults

-qnosaveopt

Usage

This option has effect only when compiling to an object (.o) file (that is, using the `-c` option). Though each object might contain multiple compilation units, only one copy of the command-line options is saved. Compiler options specified with `@PROCESS` directives are ignored.

Command-line compiler options information is copied as a string into the object file, using the following format:

```

▶▶ @(#) opt { f | c | C } invocation options

```

```

▶▶ @(#) cfg config_file_options_list

```

```

▶▶ @(#) env env_var_definition

```

where:

- f** Signifies a Fortran language compilation.
- c** Signifies a C language compilation.
- C** Signifies a C++ language compilation.

invocation

Shows the command used for the compilation, for example, `xlfc`.

options The list of command line options specified on the command line, with individual options separated by space.

config_file_options_list

The list of options specified by the **options** attribute in all configuration files that take effect in the compilation, separated by space.

env_var_definition

The environment variables that are used by the compiler. Currently only **XLFC_USR_CONFIG** is listed.

Note: You can always use this option, but the corresponding information is only generated when the environment variable **XLFC_USR_CONFIG** is set.

For more information about the environment variable **XLFC_USR_CONFIG**, see **XLFC_USR_CONFIG**.

Note: The string of the command-line options is truncated after 64,000 bytes.

Compiler version and release information, as well as the version and level of each component invoked during compilation, are also saved to the object file in the format:

```

▶▶ @(#) version { component_name Version :--VV.RR.MMMM.LLLL }

```

where:

- V** Represents the version.
- R** Represents the release.
- M** Represents the modification.
- L** Represents the level.

component_name

Specifies the components that were invoked for this compilation, such as the low-level optimizer.

product_name

Indicates the product to which the component belongs (for example, C/C++ or Fortran).

YYMMDD

Represents the year, month, and date of the installed update. If the update installed is at the base level, the level is displayed as BASE.

component_level_ID

Represents the ID associated with the level of the installed component.

If you want to simply output this information to standard output without writing it to the object file, use the **-qversion** option.

Examples

Compile `t.f` with the following command:

```
xlf t.f -c -qsaveopt -qhot
```

Issuing the **strings -a** command on the resulting `t.o` object file produces information similar to the following:

```
IBM XL Fortran for Linux, Version 15.1.5.0
@(#)opt f /opt/ibm/xlf/15.1.5/bin/xlf t.f -c -qsaveopt -qhot
@(#)cfg -qnozerosize -qsave -qalias=intptr -qposition=appendold
-qxlf90=noautodealloc:nosignedzero:oldpad
-qxlf77=intarg:intxor:persistent:noleadzero:gedit77:noblankpad:oldboz:softeof
-qxlf2003=nopolymorphic:nobozlitargs:nostopexcept:novolatile:noautorealloc:oldnaninf -bh:4
@(#)version IBM XL Fortran for Linux, V15.1.5
@(#)version 15.01.0005.0000
@(#)version Driver Version: 15.1.5(Fortran) Level: 121020 ID: _acSDAheyEeK928eKYVtYGg
@(#)version Fortran Front End and Run Time Version: 15.1.5(Fortran) Level: 121020
ID: _01piYhmQEeK928eKYVtYGg
@(#)version Fortran Transformer Version: 15.1.5(Fortran) Level: 121021
ID: _gYSYgRpREeK928eKYVtYGg
@(#)version High-Level Optimizer Version: 13.1.5(C/C++) and 15.1.5(Fortran) Level: 151106
ID: _JfAagYQ_EeWg_07EssfHAg
@(#)version Low-Level Optimizer Version: 13.1.5(C/C++) and 15.1.5(Fortran) Level: 151030
ID: _sk208X8mEeWg_07EssfHAg
```

In the first line, `t.f` identifies the source used as Fortran, `bin/xlf` shows the invocation command used, and `-qhot -qsaveopt` shows the compilation options. The second line, which starts with `cfg`, shows the compiler options added by the configuration file.

The remaining lines list each compiler component invoked during compilation, and its version and level. Components that are shared by multiple products may show more than one version number. Level numbers shown may change depending on the updates you have installed on your system.

Related information

- “-qversion” on page 260
- COMPILER_OPTIONS

-qsclk

Category

Language element control

@PROCESS

None.

Purpose

Specifies the resolution that the `SYSTEM_CLOCK` intrinsic procedure uses in a program.

Syntax

```
►► -q-sclk=centi  
          micro          
```

Defaults

The default is centisecond resolution (`-qsclk=centi`).

Related information

See `SYSTEM_CLOCK` in the *XL Fortran Language Reference* for more information on returning integer data from a real-time clock.

-qshowpdf

Category

Optimization and tuning

@PROCESS

None.

Purpose

When used with `-qpdf1` and a minimum optimization level of `-O2` at compile and link steps, creates a PDF map file that contains additional profiling information for all procedures in your application.

Syntax

```
►► -qshowpdf  
          noshowpdf
```

Defaults

`-qshowpdf`

Usage

After you run your application with typical data, the profiling information is recorded into a profile-directed feedback (PDF) file. By default, this PDF file is named `.<output_name>.pdf`, where `<output_name>` is the name of the output file that is generated when you compile your program with `-qpdf1`.

In addition to the PDF file, the compiler also generates a PDF map file that contains static information during the PDF1 step. By default, this PDF map file is named `.<output_name>_pdf_map`. With these two files, you can use the **showpdf** utility to view part of the profiling information of your application in text or XML format. For details of the **showpdf** utility, see "showpdf" in the *XL Fortran Optimization and Programming Guide*.

If you do not need to view the profiling information, specify the **-qnoshowpdf** option during the PDF1 step so that the PDF map file is not generated. This approach can reduce your compile time.

Related information

- “-qpdf1, -qpdf2” on page 202
- “showpdf” on page 289
- Correct settings for environment variables

-qsigtrap

Category

Error checking and debugging

@PROCESS

None.

Purpose

Sets up the specified trap handler to catch **SIGTRAP** and **SIGFPE** exceptions when compiling a file that contains a main program.

This option enables you to install a handler for **SIGTRAP** or **SIGFPE** signals without calling the **SIGNAL** subprogram in the program.

Syntax

```
►► -q-sigtrap _trap_handler_►►
```

Defaults

Not applicable.

Usage

If you specify the **-qsigtrap** option without a handler name, the `xl__trce` trap handler is used by default. To use a different trap handler, specify its name with the **-qsigtrap** option.

If you specify a different handler, ensure that the object module that contains it is linked with the program. To show more detailed information in the tracebacks generated by the trap handlers provided by XL Fortran (such as `xl__trce`), specify the **-qlinedebg** or **-g** option.

Related information

- “XL Fortran runtime exceptions” on page 48 describes the possible causes of exceptions.
- *Detecting and trapping floating-point exceptions in the XL Fortran Optimization and Programming Guide* describes a number of methods for dealing with exceptions that result from floating-point computations.
- *Installing an exception handler in the XL Fortran Optimization and Programming Guide* lists the exception handlers that XL Fortran supplies.

-qsimd

Category

Optimization and tuning

@PROCESS

None.

Purpose

Controls whether the compiler can automatically take advantage of vector instructions for processors that support them.

These instructions can offer higher performance when used with algorithmic-intensive tasks such as multimedia applications.

Syntax

►► `-qsimd=`

auto
noauto

 ►►

Defaults

Whether `-qsimd` is specified or not, `-qsimd=auto` is implied at the `-O3` or higher optimization level; `-qsimd=noauto` is implied at the `-O2` or lower optimization level.

Usage

The `-qsimd=auto` option enables automatic generation of vector instructions for processors that support them. When `-qsimd=auto` is in effect, the compiler converts certain operations that are performed in a loop on successive elements of an array into vector instructions. These instructions calculate several results at one time, which is faster than calculating each result sequentially. These options are useful for applications with significant image processing demands.

The `-qsimd=noauto` option disables the conversion of loop array operations into vector instructions. To achieve finer control, use `-qstrict=ieefp`, `-qstrict=operationprecision`, and `-qstrict=vectorprecision`. For details, see “`-qstrict`” on page 242.

The `-qsimd=auto` option controls the autosimdization, which was performed by the deprecated `-qhot=simd` option. If you specify `-qhot=simd`, the compiler ignores it and does not issue any warning message.

Notes:

- Specifying **-qsimd** without any suboption is equivalent to **-qsimd=auto**.
- Specifying **-qsimd=auto** does not guarantee that autosimdization will occur.
- Using vector instructions to calculate several results at one time might delay or even miss detection of floating-point exceptions on some architectures. If detecting exceptions is important, do not use **-qsimd=auto**.

Rules

If you enable IPA and specify **-qsimd=auto** at the IPA compile step, but specify **-qsimd=noauto** at the IPA link step, the compiler automatically sets **-qsimd=auto** at the IPA link step. Similarly, if you enable IPA and specify **-qsimd=noauto** at the IPA compile step, but specify **-qsimd=auto** at the IPA link step, the compiler automatically sets **-qsimd=auto** at the compile step.

Related information

- “-qarch” on page 97
- “-qreport” on page 220
- “-qstrict” on page 242
- The **NOSIMD** directive in the *XL Fortran Language Reference*.
- *Interprocedural analysis (IPA)* in the *XL Fortran Optimization and Programming Guide*.

-qslmtags

Category

Listings, messages, and compiler information

@PROCESS

None.

Purpose

Controls whether SLM Tags logging tracks compiler license usage.

Syntax

►► -q noslmtags
slmtags ◀◀

Defaults

-qnoslmtags

Usage

You can specify **-qslmtags** to enable license usage tracking. When **-qslmtags** is in effect, the compiler logs compiler license usage in the SLM Tags format, to a location that you can define by specifying the **slm_dir** attribute of the configuration file. The default location is `/var/opt/ibm/xl-compiler/` for a default installation, or `$prefix/var/opt/ibm/xl-compiler/` for a nondefault installation, where `$prefix` is the nondefault installation path. If you change the default of

`slm_dir`, you must create the target directory and set its permissions to be readable, writable, and executable by all compiler users; for example, you can run the following command:

```
chmod 777 $slm_dir
```

The compiler logs each compiler invocation as either a concurrent user or an authorized user invocation, depending on the presence of your uid in a file that lists the authorized users.

Related information

- Chapter 9, “Tracking compiler license usage,” on page 295
- “Configuration file attributes” on page 14

-qsmallstack

Category

Optimization and tuning

@PROCESS

None.

Purpose

Minimizes stack usage where possible.

This compiler option controls two distinct, but related sets of transformations: general small stack transformations and dynamic length variable allocation transformations. These two kinds of transformations can be controlled independently of each other.

Syntax

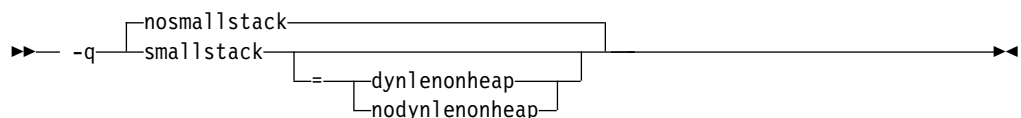

Defaults

`-qnosmallstack`

Parameters

`dynlenonheap` | `nodynlenonheap`

The `-qsmallstack=dynlenonheap` suboption affects automatic objects that have nonconstant character lengths or a nonconstant array bound (DYNAMIC LENGTH ON HEAP). When specified, those automatic variables are allocated on the heap. When this suboption is not specified, those automatic variables are allocated on the stack.

Defaults

The default, `-qnosmallstack`, implies that all suboptions are off.

Usage

Using this option may adversely affect program performance; it should be used only for programs that allocate large amounts of data on the stack.

-qsmallstack with no suboptions enables only the general small stack transformations.

-qnosmallstack only disables the general small stack transformations. To disable **dynlenonheap** transformations, specify **-qsmallstack=nodynlenonheap** as well.

-qsmallstack=dynlenonheap enables the dynamic length variable allocation and general small stack transformations.

To enable only the **dynlenonheap** transformations, specify **-qsmallstack=dynlenonheap -qnosmallstack** .

When both **-qsmallstack** and **-qstacktemp** options are used, the **-qstacktemp** setting will be used to allocate applicable temporary variables if it is set to a non-zero value, even if this setting conflicts with that of **-qsmallstack**. The **-qsmallstack** setting will continue to apply transformations not affected by **-qstacktemp**.

Related information

- “-qstacktemp” on page 239

-qsmp

Category

Optimization and tuning

@PROCESS

None.

Purpose

Enables parallelization of program code.

Syntax

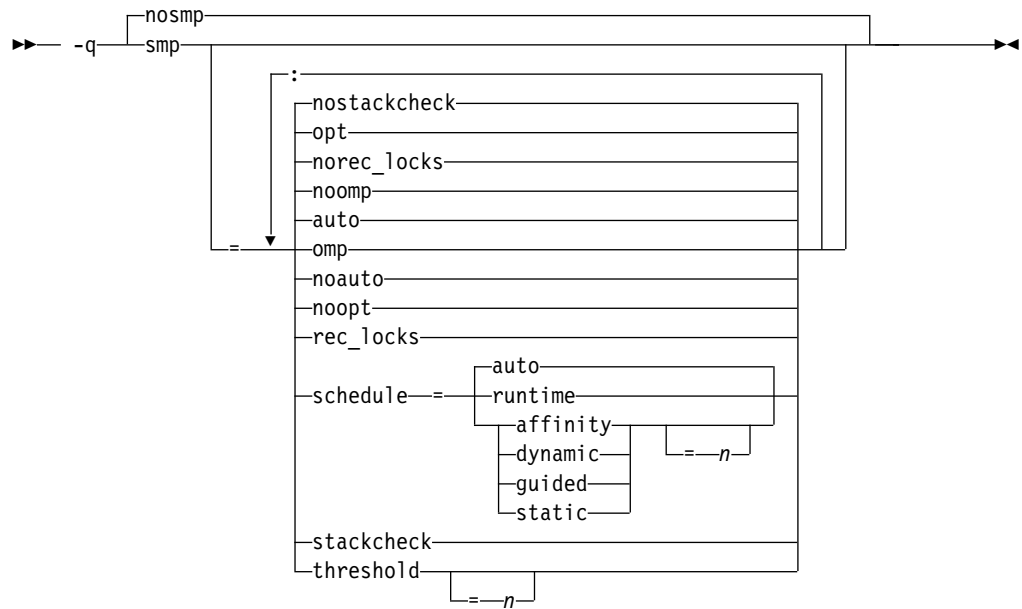

Defaults

-qnosmp. Code is produced for a uniprocessor machine.

Parameters

auto | **noauto**

auto enables automatic parallelization and optimization of program code; that is the compiler attempts to automatically parallelize both user and compiler-generated loops. **noauto** parallelizes only program code that is explicitly annotated with OpenMP directives. **noauto** is implied if you specify **-qsmp=omp** or **-qsmp=noopt**.

omp | **noomp**

omp implies **noauto**, that is, only program code that is explicitly annotated with OpenMP directives is parallelized. When **noomp** is in effect, **auto** is implied.

Specifying **omp** also has the following effects:

- The **-qqclines** compiler option is enabled.
- When the C preprocessor is invoked, the `_OPENMP` C preprocessor macro is defined based on the latest OpenMP API specification that XL Fortran supports. This macro is useful in supporting conditional compilation. See *Conditional Compilation* in the *XL Fortran Language Reference* for more information.

opt | **noopt**

opt enables optimization of parallelized program code. **noopt** performs the smallest amount of optimization that is required to parallelize the code. This is useful for debugging because **-qsmp** enables the **-O2** and **-qhot** options by default, which may result in the movement of some variables into registers that are inaccessible to the debugger. However, if the **-qsmp=noopt** and **-g** options are specified, these variables will remain visible to the debugger.

rec_locks | **norec_locks**

Determines whether recursive locks are used to avoid problems associated with CRITICAL constructs. When **rec_locks** is in effect, nested critical sections

will not cause a deadlock; a thread can enter a CRITICAL construct from within the dynamic extent of another CRITICAL construct that has the same name. Note that the **rec_locks** suboption specifies behavior for critical constructs that is inconsistent with the OpenMP API.

schedule

Specifies the type of scheduling algorithms and, except in the case of **auto**, chunk size (n) that are used for loops to which no other scheduling algorithm has been explicitly assigned in the source code. Suboptions of the **schedule** suboption are as follows:

affinity[= n]

The iterations of a loop are initially divided into n partitions, containing **ceiling**($number_of_iterations / number_of_threads$) iterations. Each partition is initially assigned to a thread and is then further subdivided into chunks that each contain n iterations. If n is not specified, then the chunks consist of **ceiling**($number_of_iterations_left_in_partition / 2$) loop iterations.

When a thread becomes free, it takes the next chunk from its initially assigned partition. If there are no more chunks in that partition, then the thread takes the next available chunk from a partition initially assigned to another thread.

The work in a partition initially assigned to a sleeping thread will be completed by threads that are active.

The **affinity** scheduling type is not part of the OpenMP API specification.

Note: This suboption has been deprecated. You can use the **OMP_SCHEDULE** environment variable with the **dynamic** clause for a similar functionality.

auto

Scheduling of the loop iterations is delegated to the compiler and runtime systems. The compiler and runtime system can choose any possible mapping of iterations to threads (including all possible valid schedule types) and these might be different in different loops. Do not specify chunk size (n).

dynamic[= n]

The iterations of a loop are divided into chunks that contain n iterations each. If n is not specified, each chunk contains one iteration.

Active threads are assigned these chunks on a "first-come, first-do" basis. Chunks of the remaining work are assigned to available threads until all work has been assigned.

guided[= n]

The iterations of a loop are divided into progressively smaller chunks until a minimum chunk size of n loop iterations is reached. If n is not specified, the default value for n is 1 iteration.

Active threads are assigned chunks on a "first-come, first-do" basis. The first chunk contains **ceiling**($number_of_iterations / number_of_threads$) iterations. Subsequent chunks consist of **ceiling**($number_of_iterations_left / number_of_threads$) iterations.

runtime

Specifies that the chunking algorithm will be determined at run time.

static[= n]

The iterations of a loop are divided into chunks containing n iterations

each. Each thread is assigned chunks in a "round-robin" fashion. This is known as *block cyclic scheduling*. If the value of n is 1, then the scheduling type is specifically referred to as *cyclic scheduling*.

If n is not specified, the chunks will contain $\text{floor}(\text{number_of_iterations} / \text{number_of_threads})$ iterations. The first $\text{remainder}(\text{number_of_iterations} / \text{number_of_threads})$ chunks have one more iteration. Each thread is assigned a separate chunk. This is known as *block scheduling*.

If a thread is asleep and it has been assigned work, it will be awakened so that it may complete its work.

n Must be an integer of value 1 or greater.

Specifying **schedule** with no suboption is equivalent to **schedule=auto**.

For more information on chunking algorithms and SCHEDULE, refer to *Directives* in the *XL Fortran Language Reference*.

stackcheck | **nostackcheck**

Causes the compiler to check for stack overflow by slave threads at run time, and issue a warning if the remaining stack size is less than the number of bytes specified by the **stackcheck** option of the XLSMPOPTS environment variable. This suboption is intended for debugging purposes, and only takes effect when **XLSMPOPTS=stackcheck** is also set; see XLSMPOPTS in the *XL Fortran Optimization and Programming Guide* for more information.

threshold[= n]

When **-qsmp=auto** is in effect, controls the amount of automatic loop parallelization that occurs. The value of n represents the minimum amount of work required in a loop in order for it to be parallelized. Currently, the calculation of "work" is weighted heavily by the number of iterations in the loop. In general, the higher the value specified for n , the fewer loops are parallelized. Specifying a value of 0 instructs the compiler to parallelize all auto-parallelizable loops, whether or not it is profitable to do so. Specifying a value of 100 instructs the compiler to parallelize only those auto-parallelizable loops that it deems profitable. Specifying a value of greater than 100 will result in more loops being serialized.

n Must be a positive integer of 0 or greater.

If you specify **threshold** with no suboption, the program uses a default value of 100.

Specifying **-qsmp** without suboptions is equivalent to:

```
-qsmp=auto:opt:noomp:norec_locks:schedule=auto:  
nostackcheck:threshold=100
```

Usage

- Specifying the **omp** suboption always implies **noauto**. Specify **-qsmp=omp:auto** to apply automatic parallelization on OpenMP-compliant applications, as well.
- The **-qsmp** option implies **-qdirective=SMP\\$\:\$OMP:IBMP**, which turns on the trigger constants **SMP\$**, **\$OMP**, and **IBMP**, in addition to the default trigger constant **IBM***.
- If you use the **f77** or **fort77** command with the **-qsmp** option to compile programs, specify **-qnosave** to make the default storage class automatic, and specify **-qthreaded** to tell the compiler to generate threadsafe code.

- Object files generated with the **-qsmp=opt** option can be linked with object files generated with **-qsmp=noopt**. The visibility within the debugger of the variables in each object file will not be affected by linking.
- Specifying **-qsmp** implicitly sets **-O2**. The **-qsmp** option overrides **-qnooptimize**, but does not override **-O3**, **-O4**, or **-O5**. When debugging parallelized program code, you can disable optimization in parallelized program code by specifying **-qsmp=noopt**.
- The **-qsmp=noopt** suboption overrides performance optimization options anywhere on the command line unless **-qsmp** appears after **-qsmp=noopt**. For example, **-qsmp=noopt -O3** is equivalent to **-qsmp=noopt**, while **-qsmp=noopt -O3 -qsmp** is equivalent to **-qsmp -O3**.

Examples

In the following example, you should specify **-qsmp=rec_locks** to avoid a deadlock caused by critical constructs.

```

program t
  integer i, a, b

  a = 0
  b = 0
!smp$ parallel do
  do i=1, 10
!smp$ critical
  a = a + 1
!smp$ critical
  b = b + 1
!smp$ end critical
!smp$ end critical
  enddo
end

```

Related information

- “-qdirective” on page 120
- “-O” on page 87
- XLSMPOPTS environment variable and Parallelization directives in the *XL Fortran Optimization and Programming Guide*

-qsource

Category

Listings, messages, and compiler information

Purpose

Produces a compiler listing file that includes the source section of the listing and provides additional source information when printing error messages.

Syntax

►► -q nosource source ◄◄

@PROCESS:

@PROCESS SOURCE | NOSOURCE

Defaults

-qnosource

Usage

This option displays on the terminal each source line where the compiler detects a problem, which can be very useful in diagnosing program errors in the Fortran source files.

You can selectively print parts of the source code by using **SOURCE** and **NOSOURCE** in **@PROCESS** directives in the source files around those portions of the program you want to print. This is the only situation where the **@PROCESS** directive does not have to be before the first statement of a compilation unit.

Examples

In the following example, the point at which the incorrect call is made is identified more clearly when the program is compiled with the **-qsource** option:

```
$ cat argument_mismatch.f
      subroutine mult(x,y)
      integer x,y
      print *,x*y
      end

      program wrong_args
      interface
          subroutine mult(a,b) ! Specify the interface for this
              integer a,b      ! subroutine so that calls to it
          end subroutine mult   ! can be checked.
      end interface
      real i,j
      i = 5.0
      j = 6.0
      call mult(i,j)
      end

$ xlf95 argument_mismatch.f
** mult      === End of Compilation 1 ===
"argument_mismatch.f", line 15.20: 1513-061 (S) Actual argument attributes
do not match those specified by an accessible explicit interface.
** wrong_args === End of Compilation 2 ===
1501-511  Compilation failed for file argument_mismatch.f.
$ xlf95 -qsource argument_mismatch.f
** mult      === End of Compilation 1 ===
    15 |  call mult(i,j)
        | .....a...
a - "argument_mismatch.f", line 15.20: 1513-061 (S) Actual argument attributes do not match those
specified by an accessible explicit interface.
** wrong_args === End of Compilation 2 ===
1501-511  Compilation failed for file argument_mismatch.f.
```

Related information

- “Listings, messages, and compiler information” on page 60
- “Source section” on page 308

-qspillsize

Category

Compiler customization

Purpose

`-qspillsize` is the long form of `-NS`. See “`-NS`” on page 86.

Syntax

►► `-qspillsize=bytes` ◄◄

@PROCESS:

@PROCESS SPILLSIZE(*bytes*)

Defaults

Not applicable.

-qstackprotect

Category

Error checking and debugging

@PROCESS

None.

Purpose

Provides protection against malicious input data or programming errors that overwrite or corrupt the stack.

Syntax

►► `-qstackprotect=proc [all] [size=N] [strong] [warn]` ◄◄

Defaults

`-qnostackprotect` when `-qstackprotect` is not specified.

`-qstackprotect=proc` when `-qstackprotect` is specified without a suboption.

Parameters

all

Protects all procedures whether or not procedures have vulnerable objects.

proc

Provides code to prevent buffer overflows.

size=N

Protects all procedures that contain automatic arrays whose sizes are greater than or equal to *N* bytes. The default size is 8 bytes when the **-qstackprotect** option is enabled.

strong

Protects additional procedures that have local array definitions or that have references to local frame addresses.

warn

Issues warnings when the size of the array contained in the function is less than *N* bytes.

Usage

-qstackprotect generates extra code to protect procedures with vulnerable objects against stack corruption. The option is disabled by default because it can degrade runtime performance.

To generate code to protect all procedures with vulnerable objects, enter the following command:

```
xlf myprogram.f -qstackprotect=all
```

To generate code to protect procedures with objects of certain size, enter the following command with the **size=** parameter set to the object size indicated in bytes:

```
xlf myprogram.f -qstackprotect=size=8
```

-qstacktemp**Category**

Optimization and tuning

Purpose

Determines where to allocate certain XL Fortran compiler temporaries at run time.

Applicable compiler temporaries are the set of temporary variables created by the compiler for its own use when it determines it can safely apply these. Most typically, the compiler creates these kinds of temporaries to hold copies of XL Fortran arrays for array language semantics, especially in conjunction with calls to intrinsic functions or user subprograms.

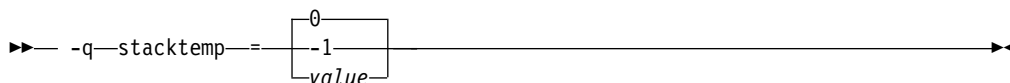
Syntax**@PROCESS:**

```
@PROCESS STACKTEMP={0 | -1 | value}
```

Defaults

```
-qstacktemp=0
```

Parameters

The possible suboptions are:

- 0** Based on the target environment, the compiler determines whether it will allocate applicable temporaries on the heap or the stack. If this setting causes your program to run out of stack storage, try specifying a nonzero value instead, or try using the **-qsmallstack** option.
- 1** Allocates applicable temporaries on the stack. Generally, this is the best performing setting but uses the most amount of stack storage.
- value* Allocates applicable temporaries less than *value* on the stack and those greater than or equal to *value* on the heap. *value* is a positive integer. A value of 1 Mb has been shown to be a good compromise between stack storage and performance for many programs, but you may need to adjust this number based on your application's characteristics.

Usage

If you have programs that make use of large arrays, you may need to use this option to help prevent stack space overflow when running them. For example, for SMP or OpenMP applications that are constrained by stack space, you can use this option to move some compiler temporaries onto the heap from the stack.

The compiler cannot detect whether or not the stack limits will be exceeded when an application runs. You will need to experiment with several settings before finding the one that works for your application. To override an existing setting, you must specify a new setting.

The **-qstacktemp** option can take precedence over the **-qsmallstack** option for certain compiler-generated temporaries.

Related information

- “-qsmallstack” on page 231

-qstaticlink

Category

Linking

@PROCESS directive

None.

Purpose

Controls whether static or shared runtime libraries are linked into an application.

This option provides the ability to specify linking rules that are equivalent to those implied by the GNU options **-static**, **-static-libgcc**, **-shared**, and **-shared-libgcc**, used singly and in combination.

Syntax

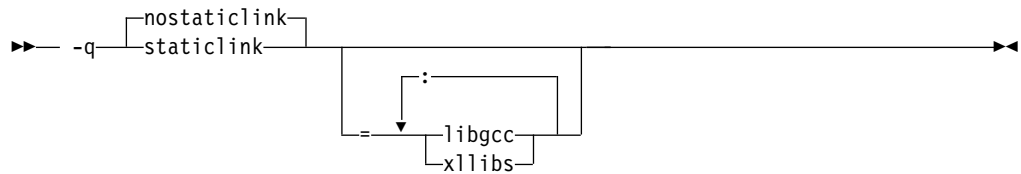

Defaults

-qnostaticlink

Parameters

libgcc

- When you specify **libgcc** with **nostaticlink**, the compiler links the shared version of **libgcc**.
- When you specify **libgcc** with **staticlink**, the compiler links the static version of **libgcc**.

This suboption provides the equivalent ability that is enabled by the GNU options **-static-libgcc** and **-shared-libgcc**.

xllibs

- When you specify **xllibs** with **-qnostaticlink**, the compiler links the shared version of the XL compiler libraries.
- When you specify **xllibs** with **-qstaticlink**, the compiler links the static version of the XL compiler libraries.

Usage

When you specify **-qstaticlink** without suboptions, only static libraries are linked with the object file.

When you specify **-qnostaticlink** without suboptions, shared libraries are linked with the object file.

When you specify **-qstaticlink=xllibs** and **-qmkshrobj**, both options take effect. The compiler creates a shared object in which all references to the XL libraries are statically linked in.

Conflicting compiler options are resolved as follows:

- If you first specify **-qnostaticlink** without suboptions and then specify **-qstaticlink** with or without suboptions, **-qnostaticlink** is overridden. For example, **-qnostaticlink -qstaticlink=xllibs** is equivalent to **-qstaticlink=xllibs**.
- If you specify **-qstaticlink** with or without suboptions followed by **-qnostaticlink** without suboptions, **-qnostaticlink** takes effect and shared libraries are linked. Otherwise, once you have specified **-qstaticlink** without suboptions, **-qstaticlink** takes effect and only static libraries are linked with the object file. See the following examples:

Table 20. Examples of conflicting compiler options and resolutions

Options combination	Compiler behavior
-qstaticlink=libgcc -qnostaticlink	Shared libraries are linked.

Table 20. Examples of conflicting compiler options and resolutions (continued)

Options combination	Compiler behavior
-qstaticlink -qnostaticlink=libgcc	All libraries are linked statically. The compiler issues the following warning message: (W) The options -qnostaticlink=libgcc and -qstaticlink are incompatible. Option -qnostaticlink=libgcc is ignored.
-qstaticlink -qnostaticlink=libgcc:xllibs	All libraries are linked statically. The compiler issues the following warning messages: (W) The options -qnostaticlink=libgcc and -qstaticlink are incompatible. Option -qnostaticlink=libgcc is ignored. (W) The options -qnostaticlink=xllibs and -qstaticlink are incompatible. Option -qnostaticlink=xllibs is ignored.
-qstaticlink -qstaticlink=libgcc	All libraries are linked statically.
-qnostaticlink=libgcc -qstaticlink	All libraries are linked statically.

Note: If a runtime library is linked in statically while its message catalog is not installed on the system, messages are issued with message numbers only, and no message text is shown.

Important: Any use of third-party libraries or products is subject to the provisions in their respective licenses. Using the **-qstaticlink** option can have significant legal consequences for the programs that you compile. It is strongly recommended that you seek legal advice before you use this option.

The following table shows the equivalent GNU and XL Fortran options for specifying linkage of shared and nonshared libraries.

Table 21. Option mappings: control of the GNU linker

GNU option	Meaning	XL Fortran option
-shared	Build a shared object.	-qmksprobj
-static	Build a static object and prevent linking with shared libraries. Every library that is linked to must be a static library.	-qstaticlink
-shared-libgcc	Link with the shared version of libgcc.	-qnostaticlink=libgcc 1
-static-libgcc	Link with the static version of libgcc. You can still link your shared libraries.	-qstaticlink=libgcc
Notes: 1 This is the default setting.		

Related information

- “-qmksprobj” on page 192

-qstrict

Category

Optimization and tuning

Purpose

Ensures that optimizations that are done by default at the **-O3** and higher optimization levels, and, optionally at **-O2**, do not alter certain program semantics mostly related to strict IEEE floating-point conformance.

This option is intended for situations where the changes in program execution in optimized programs produce different results from unoptimized programs.

Syntax

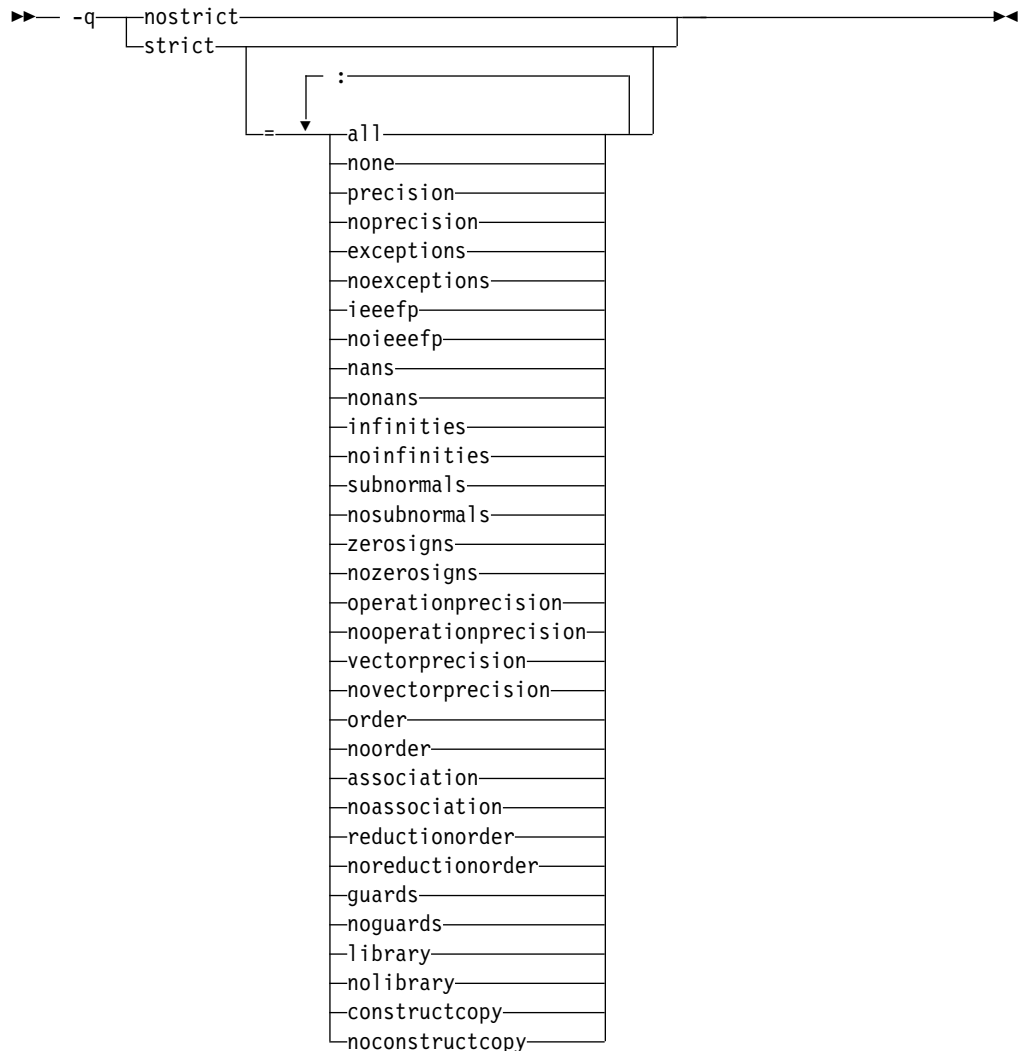

@PROCESS:

@PROCESS STRICT[(suboptions)] | NOSTRICT

Defaults

- **-qstrict** or **-qstrict=all** is always in effect when the **-qnoopt** or **-O0** optimization level is in effect
- **-qstrict** or **-qstrict=all** is the default when the **-O2** or **-O** optimization level is in effect

- `-qnostrict` or `-qstrict=none` is the default when the `-O3` or higher optimization level is in effect

Parameters

The `-qstrict` suboptions include the following:

`all` | `none`

`all` disables all semantics-changing transformations, including those controlled by the `ieee fp` , `order`, `library`, `constructcopy`, `precision`, and `exceptions` suboptions. `none` enables these transformations.

`precision` | `noprecision`

`precision` disables all transformations that are likely to affect floating-point precision, including those controlled by the `subnormals`, `operationprecision`, `vectorprecision`, `association`, `reductionorder`, and `library` suboptions. `noprecision` enables these transformations.

`exceptions` | `noexceptions`

`exceptions` disables all transformations likely to affect exceptions or be affected by them, including those controlled by the `nans`, `infinities`, `subnormals`, `guards`, `library`, and `constructcopy` suboptions. `noexceptions` enables these transformations.

`ieee fp` | `noieee fp`

`ieee fp` disables transformations that affect IEEE floating-point compliance, including those controlled by the `nans`, `infinities`, `subnormals`, `zerosigns`, `vectorprecision`, and `operationprecision` suboptions. `noieee fp` enables these transformations.

`nans` | `nonans`

`nans` disables transformations that may produce incorrect results in the presence of, or that may incorrectly produce IEEE floating-point NaN (not-a-number) values. `nonans` enables these transformations.

`infinities` | `noinfinities`

`infinities` disables transformations that may produce incorrect results in the presence of, or that may incorrectly produce floating-point infinities. `noinfinities` enables these transformations.

`subnormals` | `nosubnormals`

`subnormals` disables transformations that may produce incorrect results in the presence of, or that may incorrectly produce IEEE floating-point subnormals (formerly known as denorms). `nosubnormals` enables these transformations.

`zerosigns` | `nozerosigns`

`zerosigns` disables transformations that may affect or be affected by whether the sign of a floating-point zero is correct. `nozerosigns` enables these transformations.

`operationprecision` | `nooperationprecision`

`operationprecision` disables transformations that produce approximate results for individual floating-point operations. `nooperationprecision` enables these transformations.

`vectorprecision` | `novectorprecision`

`vectorprecision` disables vectorization in loops where it might produce different results in vectorized iterations than in nonvectorized residue iterations. `vectorprecision` ensures that every loop iteration of identical floating-point operations on identical data produces identical results.

novectorprecision enables vectorization even when different iterations might produce different results from the same inputs.

order | noorder

order disables all code reordering between multiple operations that may affect results or exceptions, including those controlled by the **association**, **reductionorder**, and **guards** suboptions. **noorder** enables code reordering.

association | noassociation

association disables reordering operations within an expression. **noassociation** enables reordering operations.

reductionorder | noreductionorder

reductionorder disables parallelizing floating-point reductions. **noreductionorder** enables parallelizing these reductions.

guards | noguards

guards disables moving operations past guards (that is, past **IF** statements, out of loops, or past subroutine or function calls that might end the program) which control whether the operation should be executed. **noguards** enables moving operations past guards.

library | nolibrary

library disables transformations that affect floating-point library functions; for example, transformations that replace floating-point library functions with other library functions or with constants. **nolibrary** enables these transformations.

constructcopy | noconstructcopy

constructcopy disables constructing arrays in place instead of using a temporary copy where an exception could occur. **noconstructcopy** enables constructing such arrays.

Usage

The **all**, **precision**, **exceptions**, **ieeefp**, and **order** suboptions and their negative forms are group suboptions that affect multiple, individual suboptions. For many situations, the group suboptions will give sufficient granular control over transformations. Group suboptions act as if either the positive or the no form of every suboption of the group is specified. Where necessary, individual suboptions within a group (like **subnormals** or **operationprecision** within the **precision** group) provide control of specific transformations within that group.

With **-qnostrict** or **-qstrict=none** in effect, the following optimizations are turned on:

- Code that may cause an exception may be rearranged. The corresponding exception might happen at a different point in execution or might not occur at all. (The compiler still tries to minimize such situations.)
- Floating-point operations may not preserve the sign of a zero value. (To make certain that this sign is preserved, you also need to specify **-qfloat=rrm**, **-qfloat=nomaf**, or **-qfloat=strictnmaf**.)
- Floating-point expressions may be reassociated. For example, $(2.0*3.1)*4.2$ might become $2.0*(3.1*4.2)$ if that is faster, even though the result might not be identical.
- The optimization functions enabled by **-qfloat=rsqrt**. You can turn off the optimization functions by using the **-qstrict** option or **-qfloat=norsqrt**. With lower-level or no optimization specified, these optimization functions are turned off by default.

Specifying various suboptions of **-qstrict[=suboptions]** or **-qnostrict** combinations sets the following suboptions:

- **-qstrict** or **-qstrict=all** sets **-qfloat=norsqrt:rngchk**. **-qnostrict** or **-qstrict=none** sets **-qfloat=rsqrt:norngchk**.
- **-qstrict=infinities**, **-qstrict=operationprecision**, or **-qstrict=exceptions** sets **-qfloat=norsqrt**.
- **-qstrict=noinfinities:nooperationprecision:noexceptions** sets **-qfloat=rsqrt**.
- **-qstrict=nans**, **-qstrict=infinities**, **-qstrict=zerosigns**, or **-qstrict=exceptions** sets **-qfloat=rsqrt:rngchk**. Specifying all of **-qstrict=nonans:nozerosigns:noexceptions** or **-qstrict=noinfinities:nozerosigns:noexceptions**, or any group suboptions that imply all of them, sets **-qfloat=norngchk**.

Note: For details about the relationship between **-qstrict** suboptions and their **-qfloat** counterparts, see “-qfloat” on page 134.

To override any of these settings, specify the appropriate **-qfloat** suboptions after the **-qstrict** option on the command line.

Examples

To compile `myprogram.f` so that the aggressive optimization of **-O3** are turned off, and division by the result of a square root is replaced by multiplying by the reciprocal (**-qfloat=rsqrt**), enter:

```
xlf myprogram.f -O3 -qstrict -qfloat=rsqrt
```

To enable all transformations except those affecting precision, specify:

```
xlf myprogram.f -qstrict=none:precision
```

To disable all transformations except those involving NaNs and infinities, specify:

```
xlf myprogram.f -qstrict=all:nonans:noinfinities
```

Related information

- “-qsimd” on page 229
- “-qessl” on page 127
- “-qfloat” on page 134
- “-qhot” on page 149
- “-O” on page 87
- “-qxl90” on page 268

-qstrictieemod

Category

Floating-point and integer control

Purpose

Specifies whether the compiler will adhere to the Fortran 2003 IEEE arithmetic rules for the `ieee_arithmetic` and `ieee_exceptions` intrinsic modules.

Syntax

►► — -q — strictieemod
nostrictieemod —►►

@PROCESS:

@PROCESS **STRICTIEEMOD** | NOSTRICTIEEMOD

Defaults

-qstrictieemod

Usage

When you specify **-qstrictieemod**, the compiler adheres to the following rules:

- If there is an exception flag set on entry into a procedure that uses the IEEE intrinsic modules, the flag is set on exit. If a flag is clear on entry into a procedure that uses the IEEE intrinsic modules, the flag can be set on exit.
- If there is an exception flag set on entry into a procedure that uses the IEEE intrinsic modules, the flag clears on entry into the procedure and resets when returning from the procedure.
- When returning from a procedure that uses the IEEE intrinsic modules, the settings for halting mode and rounding mode return to the values they had at procedure entry.
- Calls to procedures that do not use the **ieee_arithmetic** or **ieee_exceptions** intrinsic modules from procedures that do use these modules, will not change the floating-point status except by setting exception flags.

Since the above rules can impact performance, specifying **-qnostrictieemod** will relax the rules on saving and restoring floating-point status. This prevents any associated impact on performance.

-qstrict_induction

Category

Optimization and tuning

@PROCESS

None.

Purpose

Prevents the compiler from performing induction (loop counter) variable optimizations. These optimizations may be unsafe (may alter the semantics of your program) when there are integer overflow operations involving the induction variables.

Syntax

►► — -q — nostrict_induction
strict_induction —►►

Defaults

-qnostrict_induction

Usage

You should avoid specifying **-qstrict_induction** unless absolutely necessary, as it may cause performance degradation.

Examples

Consider the following two examples:

Example 1

```
integer(1) :: i, j           ! Variable i can hold a
j = 0                       ! maximum value of 127.

do i = 1, 200               ! Integer overflow occurs when 128th
  j = j + 1                 ! iteration of loop is attempted.
enddo
```

Example 2

```
integer(1) :: i             ! Variable i can hold a maximum
i = 1_1                     ! value of 127.

100 continue
  if (i == -127) goto 200   ! Go to label 200 once decimal overflow
  i = i + 1_1              ! occurs and i == -127.
  goto 100
200 continue
  print *, i
end
```

If you compile these examples with the **-qstrict_induction** option, the compiler does not perform induction variable optimizations, but the performance of the code may be affected. If you compile the examples with the **-qnostrict_induction** option, the compiler may perform optimizations that may alter the semantics of the programs.

Related information

- “-O” on page 87

-qsuffix

Category

Input control

@PROCESS

None.

Purpose

Specifies the source-file suffix on the command line.

This option saves time for the user by permitting files to be used as named with minimal makefile modifications. Only one setting is supported at any one time for any particular file type.

Syntax

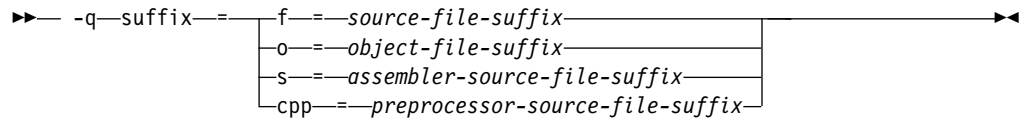

Defaults

Not applicable.

Parameters

f=*suffix*

Where *suffix* represents the new *source-file-suffix*

o=*suffix*

Where *suffix* represents the new *object-file-suffix*

s=*suffix*

Where *suffix* represents the new *assembler-source-file-suffix*

cpp=*suffix*

Where *suffix* represents the new *preprocessor-source-file-suffix*

Rules

- The new suffix setting is case-sensitive.
- The new suffix can be of any length.

Examples

For instance,

```
xlf a1.f2k a2.F2K -qsuffix=f=f2k:cpp=F2K
```

will cause these effects:

- The compiler is invoked for source files with a suffix of .f2k and .F2K.
- cpp is invoked for files with a suffix of .F2K.

-qsuppress

Category

Listings, messages, and compiler information

@PROCESS

None.

Purpose

Prevents specific informational or warning messages from being displayed or added to the listing file, if one is generated.

Syntax

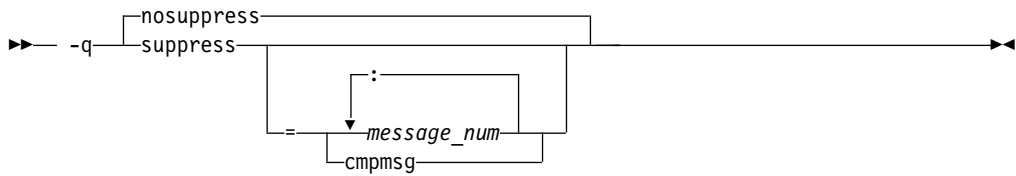

Defaults

Not applicable.

Parameters

message_num[:message_num ...]

Suppresses the display of a specific compiler message (*nnnn-mmm*) or a list of messages (*nnnn-mmm[:nnnn-mmm ...]*). To suppress a list of messages, separate each message number with a colon.

nnnn-mmm is the message number, where:

- *nnnn* must be a four-digit integer between 1500 and 1585; this is the range of XL Fortran message numbers.
- *mmm* must be any three-digit integer (with leading zeros if necessary).

cmpmsg

Suppresses the informational messages that report compilation progress and a successful completion.

This suboption has no effect on any error messages that are emitted.

Usage

In some situations, users may receive an overwhelming number of compiler messages. In many cases, these compiler messages contain important information. However, some messages contain information that is either redundant or can be safely ignored. When multiple error or warning messages appear during compilation, it can be very difficult to distinguish which messages should be noted. By using **-qsuppress**, you can eliminate messages that do not interest you.

Note:

- The compiler tracks the message numbers specified with **-qsuppress**. If the compiler subsequently generates one of those messages, it will not be displayed or entered into the listing.
- Only compiler and driver messages can be suppressed. Linker or operating system message numbers will be ignored if specified with **-qsuppress**.
- To suppress IPA messages, enter **-qsuppress** before **-qipa** on the command line.
- The **-qhaltmsg** option has precedence over **-qsuppress**. If you specify both **-qhaltmsg** and **-qsuppress**, messages that **-qsuppress** suppresses are also printed and compilation stops.

Examples

```
@process nullterm
  i = 1; j = 2;
  call printf("i=%d\n", %val(i));
  call printf("i=%d, j=%d\n", %val(i), %val(j));
end
```

Compiling this sample program would normally result in the following output:

```
"t.f", line 4.36: 1513-029 (W) The number of arguments to "printf" differ
from the number of arguments in a previous reference. You should use the
OPTIONAL attribute and an explicit interface to define a procedure with
optional arguments.
**_main   === End of Compilation 1 ===
1501-510  Compilation successful for file t.f.
```

When the program is compiled with **-qsuppress=1513-029**, the output is:

```
**_main   === End of Compilation 1 ===
1501-510  Compilation successful for file t.f.
```

Related information

- “-qflag” on page 132
- “-qhaltonmsg” on page 148
- “-qmaxerr” on page 188

-qswapomp

Category

Portability and migration

Purpose

Specifies that the compiler should recognize and substitute OpenMP routines in XL Fortran programs.

The OpenMP routines for Fortran and C have different interfaces. To support multi-language applications that use OpenMP routines, the compiler needs to recognize OpenMP routine names and substitute them with the XL Fortran versions of these routines, regardless of the existence of other implementations of such routines.

Syntax

```
► — -q ————— ◄◄
      | swapomp
      | noswapomp
```

@PROCESS:

@PROCESS SWAPOMP | NOSWAPOMP

Defaults

-qswapomp

Usage

The compiler does not perform substitution of OpenMP routines when you specify the **-qnoswapomp** option.

The **-qswapomp** and **-qnoswapomp** options only affect Fortran subprograms that reference OpenMP routines that exist in the program.

Rules

- If a call to an OpenMP routine resolves to a dummy procedure, module procedure, an internal procedure, a direct invocation of a procedure itself, or a statement function, the compiler will not perform the substitution.
- When you specify an OpenMP routine, the compiler substitutes the call to a different special routine depending upon the setting of the **-qintsize** option. In this manner, OpenMP routines are treated as generic intrinsic procedures.
- Unlike generic intrinsic procedures, if you specify an OpenMP routine in an **EXTERNAL** statement, the compiler will not treat the name as a user-defined external procedure. Instead, the compiler will still substitute the call to a special routine depending upon the setting of the **-qintsize** option.
- An OpenMP routine cannot be extended or redefined, unlike generic intrinsic procedures.

Examples

In the following example, the OpenMP routines are declared in an **INTERFACE** statement.

```
@PROCESS SWAPOMP

      INTERFACE
      FUNCTION OMP_GET_THREAD_NUM()
        INTEGER OMP_GET_THREAD_NUM
      END FUNCTION OMP_GET_THREAD_NUM

      FUNCTION OMP_GET_NUM_THREADS()
        INTEGER OMP_GET_NUM_THREADS
      END FUNCTION OMP_GET_NUM_THREADS
      END INTERFACE

      IAM = OMP_GET_THREAD_NUM()
      NP = OMP_GET_NUM_THREADS()
      PRINT *, IAM, NP
      END
```

Related information

See the *OpenMP execution environment, lock and timing routines* section in the *XL Fortran Optimization and Programming Guide*.

-qtbtable

Category

Object code control

@PROCESS

None.

Purpose

Controls the amount of debugging traceback information that is included in the object files.

Syntax



Defaults

Not applicable.

Parameters

- full** The object code contains full traceback information. The program is debuggable, and if it stops because of a runtime exception, it produces a traceback listing that includes the names of all procedures in the call chain.
- none** The object code contains no traceback information at all. You cannot debug the program, because a debugger or other code-examination tool cannot unwind the program's stack at run time. If the program stops because of a runtime exception, it does not explain where the exception occurred.
- small** The object code contains traceback information but not the names of procedures or information about procedure parameters. You can debug the program, but some non-essential information is unavailable to the debugger. If the program stops because of a runtime exception, it explains where the exception occurred but reports machine addresses rather than procedure names.

Defaults

- Code compiled with **-g** or without **-O** has full traceback information (**-qtbtable=full**).
- Code compiled with **-O** or higher optimization contains less traceback information (**-qtbtable=small**).

Usage

This option is most suitable for programs that contain many long procedure names, such as the internal names constructed for module procedures. You may find it more applicable to C++ programs than to Fortran programs.

You can use this option to make your program smaller, at the cost of making it harder to debug. When you reach the production stage and want to produce a program that is as compact as possible, you can specify **-qtbtable=none**. Otherwise, the usual defaults apply.

Related information

- “-g” on page 77
- “-qcompact” on page 111
- “-O” on page 87
- *Debugging optimized code* in the *XL Fortran Optimization and Programming Guide*

-qthreaded

Category

Object code control

@PROCESS

None.

Purpose

Indicates to the compiler whether it must generate threadsafe code.

Syntax

►► -q—threaded—►►

Defaults

-qthreaded is the default for the `xlf_r`, `xlf90_r`, `xlf95_r`, `xlf2003_r`, `xlf2008_r`, and `xlcuCUDA Fortranf` `xlcuCUDA Fortran` commands.

Usage

Specifying the **-qthreaded** option implies **-qdirective=ibmt**, and by default, the *trigger_constant* **IBMT** is recognized.

The **-qthreaded** option does not imply the **-qnosave** option. The **-qnosave** option specifies a default storage class of automatic for user local variables. In general, both of these options need to be used to generate threadsafe code. Specifying these options ensures that variables and code created by the compiler are threadsafe; it does not guarantee the thread safety of user-written code.

The **-qthreaded** option does not imply the **-qxlf77=nopersistent** option. The **-qxlf77=nopersistent** option improves thread safety by preventing the compiler from saving the addresses of arguments to subprograms with the **ENTRY** statements in static storage.

-qtimestamps

Category

“Output control” on page 51

@PROCESS

None.

Purpose

Controls whether or not implicit time stamps are inserted into an object file.

Syntax

►► -q—

timestamps
not timestamps

—►►

Defaults

-qtimestamps

Usage

By default, the compiler inserts an implicit time stamp in an object file when it is created. In some cases, comparison tools may not process the information in such binaries properly. Controlling time stamp generation provides a way of avoiding such problems. To omit the time stamp, use the option **-qnotimestamps**.

This option does not affect time stamps inserted by pragmas and other explicit mechanisms.

-qtune

Category

Optimization and tuning

@PROCESS

None.

Purpose

Tunes instruction selection, scheduling, and other architecture-dependent performance enhancements to run best on a specific hardware architecture. Allows specification of a target SMT mode to direct optimizations for best performance in that mode.

Syntax

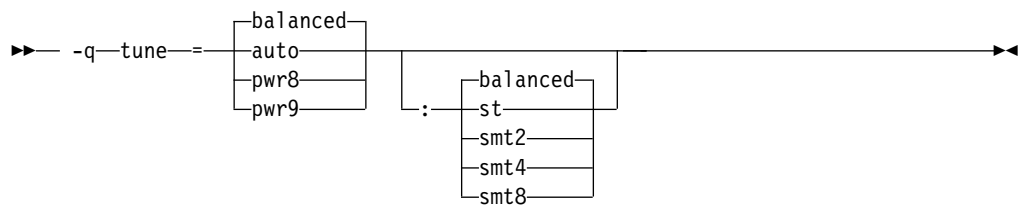

Defaults

-qtune=balanced:balanced when no valid **-qarch** setting is in effect. Otherwise, the default depends on the effective **-qarch** setting. You can find details in Acceptable **-qarch** and **-qtune** combinations.

Parameters for CPU suboptions

The following CPU suboptions allow you to specify a particular architecture for the compiler to target for best performance:

auto

Optimizations are tuned for the platform on which the application is compiled.

balanced

Optimizations are tuned across a selected range of recent hardware.

pwr8

Optimizations are tuned for the POWER8 hardware platform.

pwr9

Optimizations are tuned for the POWER9 hardware platform.

Parameters for SMT suboptions

The following simultaneous multithreading (SMT) suboptions allow you to optionally specify an execution mode for the compiler to target for best performance.

balanced

Optimizations are tuned for performance across various SMT modes for a selected range of recent hardware.

st Optimizations are tuned for single-threaded execution.

smt2

Optimizations are tuned for SMT2 execution mode (two threads).

smt4

Optimizations are tuned for SMT4 execution mode (four threads).

smt8

Optimizations are tuned for SMT8 execution mode (eight threads).

Usage

By arranging (scheduling) the generated machine instructions to take maximum advantage of hardware features such as cache size and pipelining, **-qtune** can improve performance. It only has an effect when used in combination with options that enable optimization.

Although changing the **-qtune** setting may affect the performance of the resulting executable, it has no effect on whether the executable can be executed correctly on a particular hardware platform.

You can find the acceptable combinations of **-qarch** and **-qtune** in the following table.

Table 22. Acceptable -qarch and -qtune combinations

-qarch option	Default -qtune setting	Available -qtune CPU settings	Available -qtune SMT settings
pwr8	pwr8:st	auto pwr8 pwr9 balanced	balanced st smt2 smt4 smt8
pwr9	pwr9:st	auto pwr9 balanced	balanced st smt2 smt4 smt8

Examples

The executable program `testing` is compiled from `myprogram.c`. To specify `testing` is to be optimized for a POWER8 hardware platform and configured for the SMT4 mode, enter:

```
xlf -o testing myprogram.f -qtune=pwr8:smt4
```

Related information

- “-qarch” on page 97
- "Optimizing your applications" in the *XL Fortran Optimization and Programming Guide*

-qfmt

Category

Portability and migration

Purpose

Sets the byte order for I/O operations on unformatted data files.

Syntax

►► -q-ufmt =le
=be ◀◀

@PROCESS:

@PROCESS UFMT[({BE | LE})]

Defaults

-qfmt=le

Parameters

- be** Specifies that I/O operations on unformatted data files use the big-endian byte order. This option provides compatibility with big-endian data files at the cost of runtime performance. The byte order of non-character data and record markers is converted in real time during I/O operations.
- le** Specifies that I/O operations on unformatted data files use the little-endian byte order. This option provides better performance because data and record markers are read and written from unformatted data files without converting the byte order.

Usage

You can specify the byte order for I/O operations in the following ways. If more than one is specified for the same unit and they conflict with each other, the one that comes first in the list takes precedence:

1. Runtime option **XLFRT_OPTS=ufmt_bigendian**
2. **CONVERT= char_expr** in the **OPEN** statement, where *char_expr* is **NATIVE**, **BIG_ENDIAN**, or **LITTLE_ENDIAN**
3. @PROCESS UFMT(BE) or @PROCESS UFMT(LE)
4. Compiler option **-qfmt=be** or **-qfmt=le**

Related information

- "OPEN statement" in the *XL Fortran Language Reference*
- “The XLFRT_OPTS environment variable” on page 37

-qundef

Category

Language element control

Purpose

-qundef is the long form of the “-u” on page 281 option.

Syntax

►► -q nundef
 undef

@PROCESS:

@PROCESS UNDEF | NUNDEF

Defaults

-qnundef

-qunroll

Category

Optimization and tuning

@PROCESS

None.

Purpose

Specifies whether unrolling **DO** loops is allowed in a program. Unrolling is allowed on outer and inner **DO** loops.

Syntax

►► -q unroll
 nounroll
 = auto
 yes
 n

Defaults

-qunroll=auto

Parameters

auto The compiler performs basic loop unrolling.

yes The compiler looks for more opportunities to perform loop unrolling than that performed with **-qunroll=auto**. In general, this suboption has more

chances to increase compile time or program size than **-qunroll=auto** processing, but it may also improve your application's performance.

n Instructs the compiler to unroll loops by a factor of *n*. In other words, the body of a loop is replicated to create *n* copies and the number of iterations is reduced by a factor of $1/n$. The value of *n* must be a positive integer.

Specifying **-qunroll=1** disables loop unrolling, and is equivalent to specifying **-qnounroll**. If *n* is not specified and if **-qhot**, **-qsmp**, **-O4**, or **-O5** is specified, the optimizer determines an appropriate unrolling factor for each nested loop.

The compiler might limit unrolling to a number smaller than the value you specify for *n*. The reason is that the option affects all loops in source files to which it applies and large unrolling factors might significantly increase compile time without necessarily improving runtime performance. To specify a specific unrolling factor for particular loops, use the unroll directive in those loops.

If you decide to unroll a loop, specifying one of the above suboptions does not automatically guarantee that the compiler will perform the operation. Based on the performance benefit, the compiler will determine whether unrolling will be beneficial to the program. Experienced compiler users should be able to determine the benefit in advance.

Usage

Specifying **-qunroll** with no suboptions is equivalent to **-qunroll=yes**.

The **-qnounroll** option prohibits unrolling unless you specify the **STREAM_UNROLL**, **UNROLL**, or **UNROLL_AND_FUSE** directive for a particular loop. These directives always override the command line options.

Examples

In the following example, the **UNROLL(2)** directive is used to tell the compiler that the body of the loop can be replicated so that the work of two iterations is performed in a single iteration. Instead of performing 1000 iterations, if the compiler unrolls the loop, it will only perform 500 iterations.

```
!IBM* UNROLL(2)
DO I = 1, 1000
  A(I) = I
END DO
```

If the compiler chooses to unroll the previous loop, the compiler translates the loop so that it is essentially equivalent to the following:

```
DO I = 1, 1000, 2
  A(I) = I
  A(I+1) = I + 1
END DO
```

Related information

See the appropriate directive on unrolling loops in the *XL Fortran Language Reference*:

- **STREAM_UNROLL**
- **UNROLL**
- **UNROLL_AND_FUSE**

-qunwind

Category

Optimization and tuning

Purpose

Specifies that the compiler will preserve the default behavior for saves and restores to volatile registers during a procedure call.

Syntax

►► -q unwind
nounwind ◀◀

@PROCESS:

@PROCESS UNWIND | NOUNWIND

Defaults

-qunwind

Usage

If you specify **-qnounwind**, the compiler rearranges subprograms to minimize saves and restores to volatile registers. This rearrangement may make it impossible for the program or debuggers to walk through or "unwind" subprogram stack frame chains.

While code semantics are preserved, applications such as exception handlers that rely on the default behavior for saves and restores can produce undefined results. When using **-qnounwind** in conjunction with the **-g** compiler option, debugging information regarding exception handling when unwinding the program's stack can be inaccurate.

-qversion

Category

Listings, messages, and compiler information

@PROCESS

None.

Purpose

Displays the version and release of the compiler being invoked.

Syntax

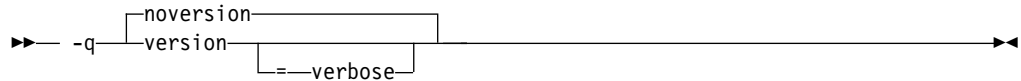

Defaults

-qnoverversion

Parameters

verbose

Displays information about the version, release, and level of each compiler component installed.

Usage

When you specify **-qversion**, the compiler displays the version information and exits; compilation is stopped. If you want to save this information to the output object file, you can do so with the **-qsaveopt -c** options.

-qversion specified without the **verbose** suboption shows compiler information in the format:

```
product_nameVersion: VV.RR.MMMM.LLLL
```

where:

V Represents the version.
R Represents the release.
M Represents the modification.
L Represents the level.

For more details, see Example 1.

-qversion=verbose shows component information in the following format:

```
component_name Version: VV.RR(product_name) Level: component_build_date ID:  
component_level_ID
```

where:

component_name
Specifies an installed component, such as the low-level optimizer.
component_build_date
Represents the build date of the installed component.
component_level_ID
Represents the ID associated with the level of the installed component.

For more details, see Example 2.

Example 1

The output of specifying the **-qversion** option:

```
IBM XL Fortran for Linux, V15.1.5 (5765-J10; 5725-C75)  
Version: 15.01.0002.0000
```

Example 2

The output of specifying the **-qversion=verbose** option:

```
IBM XL Fortran for Linux, V15.1.5 (5765-J10; 5725-C75)
Version: 15.01.0005.0000
Driver Version: 15.1.5(Fortran) Level: 150508
ID: _hnbfIvWfEeSjz7qEhQiYJQ
Fortran Front End and Run Time Version: 15.1.5(Fortran) Level: 150512
ID: _mQf28vkLEeSjz7qEhQiYJQ
Fortran Transformer Version: 15.1.5(Fortran) Level: 150506
ID: _Ax_9Eu1CEeSbzZ-i2Itj4A
High-Level Optimizer Version: 13.1.5(C/C++) and 15.1.5(Fortran)
Level: 150512 ID: _mSHAgvkLEeSjz7qEhQiYJQ
Low-Level Optimizer Version: 13.1.5(C/C++) and 15.1.5(Fortran)
Level: 150511 ID: _YY5AQvhCEeSjz7qEhQiYJQ
```

Related information

- “-qsaveopt” on page 224
- COMPILER_VERSION

-qvisibility

Category

Optimization and tuning

Purpose

Specifies the visibility attribute for external linkage symbols in object files.

Syntax

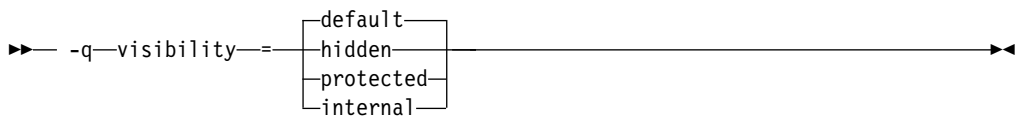

```
@PROCESS:  
@PROCESS VISIBILITY(suboption)
```

Defaults

-qvisibility=default

Parameters

default

Indicates that the affected external linkage symbols have the default visibility attribute. These symbols are exported in shared libraries, and they can be preempted.

hidden

Indicates that the affected external linkage symbols have the hidden visibility attribute. These symbols are not exported to the shared libraries, but addresses of these symbols can be referenced indirectly by pointers.

internal

Indicates that the affected external linkage symbols have the internal visibility

attribute. These symbols are not exported to the shared libraries, and addresses of these symbols are not available to other modules in shared libraries.

protected

Indicates that the affected external linkage symbols have the protected visibility attribute. These symbols are exported to the shared libraries, but they cannot be preempted.

Usage

The **-qvisibility** option globally sets visibility attributes for external linkage symbols. The purpose is to describe whether and how a symbol defined in one module can be referenced or used in other modules. The symbol visibility attribute affects the symbols with external linkage only, and cannot increase the visibility of other symbols. Symbol preemption occurs when a symbol definition is resolved at link time, but is replaced with another symbol definition at run time.

Example

To set the protected visibility attribute for external linkage symbols in the compilation unit `myprogram.f`, run the following command:

```
xlf myprogram.f -qvisibility=protected -c
```

In this example, all external linkage symbols in the compilation unit `myprogram.f` will have protected visibility.

Related information

“Linking a library to an application” on page 24

“Dynamic and static linking” on page 35

“XL Fortran output files” on page 27

-qwarn64

Category

Error checking and debugging

@PROCESS

None.

Purpose

Displays informational messages identifying statements that may cause problems with 32-bit to 64-bit migration.

This option aids in porting code from a 32-bit to a 64-bit environment by detecting the truncation of an 8-byte integer pointer to 4 bytes.

Syntax

►► — -q nowarn64
warn64 —►►

Defaults

`-qnowarn64`

Usage

The compiler flags the following situations with informational messages:

- The assignment of a reference to the **LOC** intrinsic to an **INTEGER(4)** variable.
- The assignment between an **INTEGER(4)** variable or **INTEGER(4)** constant and an integer pointer.
- The specification of an integer pointer within a common block.
- The specification of an integer pointer within an equivalence statement.

You can use interface blocks for argument checking.

Related information

- Chapter 8, “Using XL Fortran in a 64-bit environment,” on page 293

-qxflag=dvz

Category

Error checking and debugging

@PROCESS

None.

Purpose

Causes the compiler to generate code to detect floating-point divide-by-zero operations.

Syntax

►► `-qxflag=` `—dvz` ◀◀

Defaults

Not applicable.

Usage

This option takes effect at optimization levels of **-O** or higher.

With this option on, the extra code calls the external handler function `__xl_dzx` when the divisor is zero. The return value of this function is used as the result of the division. Users are required to provide the function to handle the divide-by-zero operations. Specifying `-qxflag=dvz` handles only single-precision (REAL*4) and double-precision (REAL*8) division.

The interface of the function is as follows:

```

real(8) function __xl_dzx(x, y, kind_type)
  real(8), value :: x, y
  integer, value :: kind_type
end function

```

where

x is the dividend value.

y is the divisor value.

kind_type

specifies the size of the actual arguments associated with **x** and **y**.

A **kind_type** value equal to zero indicates that the actual arguments associated with **x** and **y** are of type REAL(8). A **kind_type** value equal to one indicates that the actual arguments associated with **x** and **y** are of type REAL(4).

The division always executes before the handler routine is called. This means that any exception is posted and handled before the handler function is called.

Related information

- *Implementation details of XL Fortran floating-point processing in the XL Fortran Optimization and Programming Guide*
- “-qflttrap” on page 138
- “Understanding XL Fortran error messages” on page 299

-qxflag=oldtab

Category

Portability and migration

Purpose

Interprets a tab in columns 1 to 5 as a single character (for fixed source form programs).

Syntax

►► -qxflag=oldtab ◀◀

@PROCESS:

@PROCESS XFLAG(OLDTAB)

Defaults

By default, the compiler allows 66 significant characters on a source line after column 6. A tab in columns 1 through 5 is interpreted as the appropriate number of blanks to move the column counter past column 6. This default is convenient for those who follow the earlier Fortran practice of including line numbers or other data in columns 73 through 80.

Usage

If you specify the option **-qxflag=oldtab**, the source statement still starts immediately after the tab, but the tab character is treated as a single character for

counting columns. This setting allows up to 71 characters of input, depending on where the tab character occurs.

-qxlf77

Category

Language element control

Purpose

Provides compatibility with FORTRAN 77 aspects of language semantics and I/O data format that have changed.

Most of these changes are required by the Fortran 90 standard.

Syntax

Option:

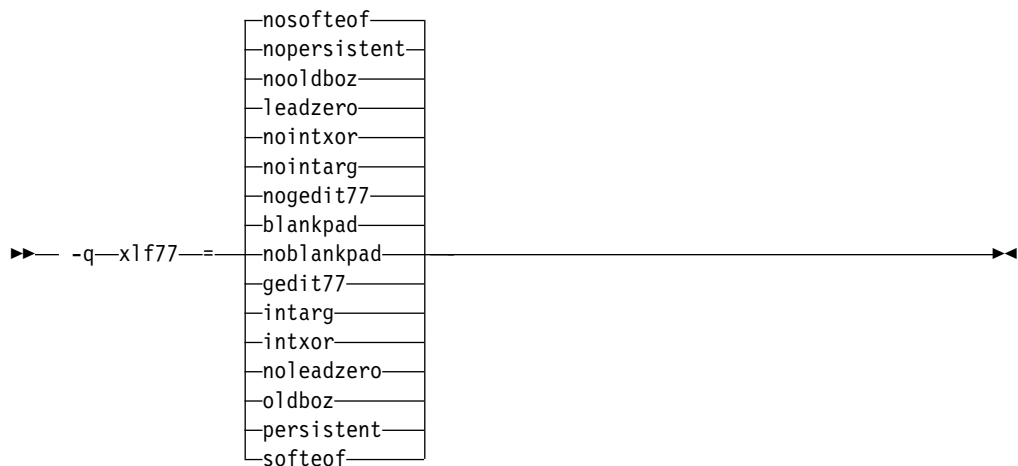

@PROCESS:

@PROCESS XLF77(*settings*)

Defaults

By default, the compiler uses settings that apply to Fortran 90, Fortran 95, Fortran 2003, Fortran 2008, and the most recent compiler version in all cases.

The default suboptions are: **blankpad**, **nogedit77**, **nointarg**, **nointxor**, **leadzero**, **nooldboz**, **nopersistent**, and **nosofteof**.

These defaults are only used by the `xlf90`, `f90`, `xlf90_r`, `xlf95`, `f95`, `xlf95_r`, `xlf2003`, `f2003`, `xlf2003_r`, `xlf2008`, `f2008`, `xlf2008_r`, and `CUDA Fortran xlcuf` `CUDA Fortran` commands, which you should use to compile new programs.

Parameters

To get various aspects of XL Fortran Version 2 behavior, select the nondefault choice for one or more of the following suboptions. The descriptions explain what happens when you specify the nondefault choices.

blankpad | **noblankpad**

For internal, direct-access, and stream-access files, uses a default setting equivalent to **pad='no'**. This setting produces conversion errors when reading from such a file if the format requires more characters than the record has. This suboption does not affect direct-access or stream-access files opened with a **pad=** specifier.

gedit77 | nogedit77

Uses FORTRAN 77 semantics for the output of **REAL** objects with the **G** edit descriptor. Between FORTRAN 77 and Fortran 90, the representation of 0 for a list item in a formatted output statement changed, as did the rounding method, leading to different output for some combinations of values and **G** edit descriptors.

intarg | nointarg

Converts all integer arguments of an intrinsic procedure to the kind of the longest argument if they are of different kinds. Under Fortran 90/95 rules, some intrinsics (for example, **IBSET**) determine the result type based on the kind of the first argument; others (for example, **MIN** and **MAX**) require that all arguments be of the same kind.

intxor | nointxor

Treats **.XOR.** as a logical binary intrinsic operator. It has a precedence equivalent to the **.EQV.** and **.NEQV.** operators and can be extended with an operator interface. (Because the semantics of **.XOR.** are identical to those of **.NEQV.**, **.XOR.** does not appear in the Fortran 90 or Fortran 95 language standard.)

Otherwise, the **.XOR.** operator is only recognized as a defined operator. The intrinsic operation is not accessible, and the precedence depends on whether the operator is used in a unary or binary context.

leadzero | **noleadzero**

Produces a leading zero in real output under the **D**, **E**, **L**, **F**, and **Q** edit descriptors.

oldboz | nooldboz

Turns blanks into zeros for data read by **B**, **O**, and **Z** edit descriptors, regardless of the **BLANK=** specifier or any **BN** or **BZ** control edit descriptors. It also preserves leading zeros and truncation of too-long output, which is not part of the Fortran 90 or Fortran 95 standard.

persistent | nopersistent

Saves the addresses of arguments to subprograms with **ENTRY** statements in static storage. This is an implementation choice that has been changed for increased performance.

softeof | nosofteof

Allows **READ** and **WRITE** operations when a unit is positioned after its endfile record unless that position is the result of executing an **ENDFILE** statement. This suboption reproduces a FORTRAN 77 extension of earlier versions of XL Fortran that some existing programs rely on.

Usage

If you only want to compile and run old programs unchanged, you can continue to use the appropriate invocation command and not concern yourself with this option.

You should only use this option if you are using existing source or data files with Fortran 90, Fortran 95, Fortran 2003, and Fortran 2008 and the `xlf90`, `f90`, `xlf90_r`, `xlf95`, `f95`, `xlf95_r`, `xlf2003`, `f2003`, `xlf2003_r`, `xlf2008`, `f2008`, `xlf2008_r`, or `CUDA Fortran xlcuf` `CUDA Fortran` command and find some incompatibility because of behavior or data format that has changed.

Eventually, you should be able to recreate the data files or modify the source files to remove the dependency on the old behavior.

-qxlf90

Category

Language element control

Purpose

Provides compatibility with the Fortran 90 standard for certain aspects of the Fortran language.

Syntax

Option:

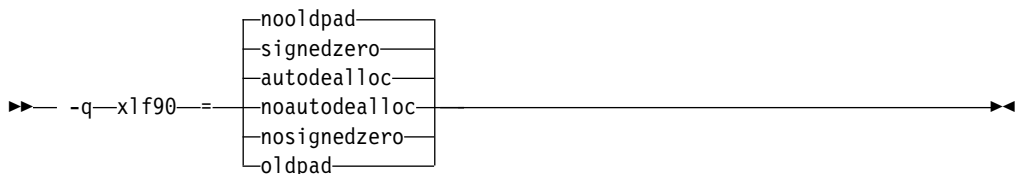

@PROCESS:

@PROCESS XLF90(*settings*)

Defaults

The default suboptions for `-qxlf90` depend on the invocation command that you specify.

For the `xlf95`, `f95`, `xlf95_r`, `xlf2003`, `f2003`, `xlf2003_r`, `xlf2008`, `f2008`, `xlf2008_r`, or `CUDA Fortran xlcuf` `CUDA Fortran` command, the default suboptions are **signedzero**, **autodealloc**, and **nooldpad**.

For all other invocation commands, the defaults are **nosignedzero**, **noautodealloc** and **oldpad**.

Parameters

signedzero | **nosignedzero**

Determines how the **SIGN(A,B)** function handles signed real 0.0.If you

specify the `-qxlf90=signedzero` compiler option, `SIGN(A,B)` returns `-|A|` when `B=-0.0`. This behavior conforms to the Fortran 95 standard and is consistent with the IEEE standard for binary floating-point arithmetic. Note that for the `REAL(16)` data type, XL Fortran never treats zero as negative zero.

This suboption also determines whether a minus sign is printed in the following cases:

- For a negative zero in formatted output. Again, note that for the `REAL(16)` data type, XL Fortran never treats zero as negative zero.
- For negative values that have an output form of zero (that is, where trailing non-zero digits are truncated from the output so that the resulting output looks like zero). Note that in this case, the `signedzero` suboption does affect the `REAL(16)` data type; non-zero negative values that have an output form of zero will be printed with a minus sign.

When using `-qxlf90=nosignedzero`, consider setting the `-qstrict=nozerosigns` option to improve performance.

autodealloc | noautodealloc

Determines whether the compiler deallocates allocatable objects that are declared locally without either the `SAVE` or the `STATIC` attribute and have a status of currently allocated when the subprogram terminates. This behavior conforms with the Fortran 95 standard. If you are certain that you are deallocating all local allocatable objects explicitly, you may want to turn off this suboption to avoid possible performance degradation.

oldpad | nooldpad

When the `PAD=specifier` is present in the `INQUIRE` statement, specifying `-qxlf90=nooldpad` returns UNDEFINED when there is no connection, or when the connection is for unformatted I/O. This behavior conforms with the Fortran 95 standard and above. Specifying `-qxlf90=oldpad` preserves the Fortran 90 behavior.

Examples

Consider the following program:

```
PROGRAM TESTSIGN
REAL X, Y, Z
X=1.0
Y=-0.0
Z=SIGN(X,Y)
PRINT *,Z
END PROGRAM TESTSIGN
```

The output from this example depends on the invocation command and the `-qxlf90` suboption that you specify. For example:

Invocation Command/xlf2008 Suboption	Output
xlf2008	-1.0
xlf2008 -qxlf90=signedzero	-1.0
xlf2008 -qxlf90=nosignedzero	1.0
xlf2003	-1.0
xlf2003 -qxlf90=signedzero	-1.0
xlf2003 -qxlf90=nosignedzero	1.0
xlf95	-1.0

Invocation Command/xlf2008 Suboption	Output
xlf95 -qxlf90=signedzero	-1.0
xlf95 -qxlf90=nosignedzero	1.0
xlf90	1.0
xlf	1.0

Related information

- See the **SIGN** information in the *Intrinsic Procedures* section and the *Array concepts* section of the *XL Fortran Language Reference*.
- “-qstrict” on page 242

-qxlf2003

Category

Language element control

Purpose

Provides the ability to use language features specific to the Fortran 2003 standard when compiling with compiler invocations that conform to earlier Fortran standards, as well as the ability to disable these features when compiling with compiler invocations that conform to the Fortran 2003 standard.

Syntax

Option:

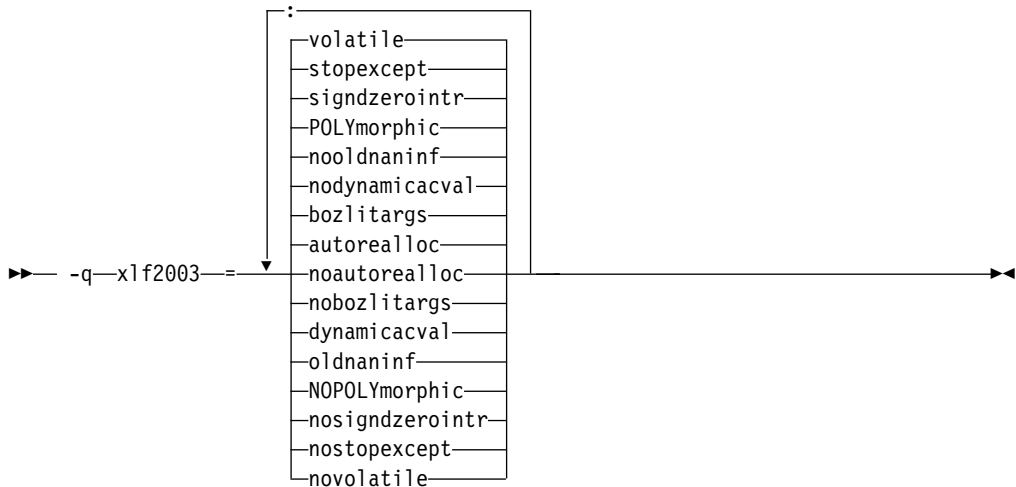

@PROCESS:

@PROCESS XLF2003(suboption,suboption,...)

Defaults

The default suboption depends on the invocation command that you specify.

The **f2003**, **xlf2003**, or **xlf2003_r** command has the following defaults:

**autorealloc:bozlitargs:nodynamicacval:nooldnaninf:polymorphic:signdzerointr:
stopexcept:volatile**

All other invocation commands have the following defaults:

**noautorealloc:nobozlitargs:nodynamicacval:oldnaninf:nopolymorphic:
nosigndzerointr:nostopexcept:novolatile**

Parameters

autorealloc | **noautorealloc**

Controls whether the compiler automatically reallocates the left-hand-side (LHS) with the shape of the right-hand-side (RHS) when assigning into an allocatable variable. If the LHS variable was not allocated before the assignment, it is allocated automatically. The default is **autorealloc** for the **f2003**, **xl f2003**, and **xl f2003_r** commands, and **noautorealloc** for all other commands. This suboption has no effect on reallocation when the values of length type parameters in the LHS and RHS differ.

bozlitargs | **nobozlitargs**

The **bozlitargs** suboption ensures that the passing of boz-literal constants as arguments to the **INT**, **REAL**, **CMPLX**, or **DBLE** intrinsic function conforms to the Fortran 2003 standard. The default is **bozlitargs** for the **f2003**, **xl f2003**, and **xl f2003_r** commands. The **-qlanglvl=2003pure** or **-qlanglvl=2003std** option must be specified, as well. If **-qport=typ1ssarg** and **-qxl f2003=bozlitargs** are specified, passing boz-literal constants to the **CMPLX** intrinsic will yield non-standard results.

dynamicacval | **nodynamicacval**

When **dynamicacval** is in effect, the dynamic types of array constructor values are used to determine the type of the array constructors and you can use unlimited polymorphic entities in array constructors. When **nodynamicacval** is in effect, the declared types of array constructor values are used to determine the type of the array constructors and you cannot use unlimited polymorphic entities in array constructors.

Note: To make the **-qxl f2003=dynamicacval** option effective, you must also specify **-qxl f2003=polymorphic**.

oldnaninf | **nooldnaninf**

The **oldnaninf** suboption controls the formatting of the output of IEEE NaN and infinity exceptional values. This suboption has no effect on input. When **oldnaninf** is in effect, the compiler uses the XL Fortran V10.1 (and earlier) behavior for output. That is, **INF** for infinity, **NAN** for a quiet or signaling NaN.

When **nooldnaninf** is in effect, the compiler output for IEEE exceptional values is compliant with the Fortran 2003 standard. That is, **Inf** for infinity, **NaN(Q)** for a quiet NaN, and **NaN(S)** for a signaling NaN.

polymorphic | **nopolymorphic**

When **polymorphic** is in effect, the compiler allows polymorphic items in Fortran source files. You can specify the **CLASS** type specifier, the **SELECT TYPE** construct, and use polymorphic items in other Fortran statements. The use of the polymorphic argument also causes the compiler to produce runtime type information for each derived type definition.

When **nopolymorphic** is in effect, polymorphic items cannot be specified in Fortran source files and no runtime type information is generated.

signdzerointr | nosigndzerointr

When **signdzerointr** is in effect, the passing of signed zeros to the **SQRT**, **LOG**, and **ATAN2** intrinsic functions returns results consistent with the Fortran 2003 standard. The **-qxf90=signedzero** option must be in effect, as well. For the **xlf**, **xlf_r**, **f77**, **fort77**, **xlf90**, **xlf90_r**, and **f90** invocations, specify both options to have the Fortran 2003 behavior.

The following example shows the use of this suboption:

```
! If the Test program is compiled with -qxf2003=signdzerointr
! and -qxf90=signedzero, then Fortran 2003 behavior is seen.
! Otherwise, this program will demonstrate Fortran 95 behavior.
```

Program Test

```
real a, b
complex j, l
a = -0.0
j = sqrt(cmplx(-1.0,a))
b = atan2(a,-1.0)
l = log(cmplx(-1.0,a))
print *, 'j=', j
print *, 'b=', b
print *, 'l=', l
end
```

! Fortran 95 output:

```
j= (-0.0000000000E+00,1.000000000)
b= 3.141592741
l= (0.0000000000E+00,3.141592741)
```

! Fortran 2003 output:

```
j= (0.0000000000E+00,-1.000000000)
b= -3.141592741
l= (0.0000000000E+00,-3.141592741)
```

stopexcept | nostopexcept

When **stopexcept** is in effect, informational messages are displayed when IEEE floating-point exceptions are signaled by a **STOP** statement. Messages have the format:

```
STOP [stop-code]
(OVERFLOW, DIV-BY-ZERO, INVALID, UNDERFLOW, INEXACT)
```

where *stop-code* corresponds to the optional digit string or character constant specified in the **STOP** statement. **OVERFLOW**, **DIV-BY-ZERO**, **INVALID**, **UNDERFLOW** and **INEXACT** appear only if the corresponding flag is set.

The following example shows corresponding messages generated:

```
real :: r11, r12, r13, r14
logical :: l

r11 = 1.3
r12 = 0.0

r13 = r11 / r12 ! divide by zero

r14 = r13 ! to make sure r13 is actually used

r14 = log(-r11) ! invalid input for log
```



```
stop "The End"
```

```
end
```

Output:

```
STOP The End  
(DIV-BY-ZERO, INVALID)
```

When **nostopexcept** is in effect, informational messages are suppressed.

volatile | novolatile

When **volatile** is in effect, a nonvolatile entity that is use- or host-associated can be specified as VOLATILE in inner or local scope.

Usage

If the application uses F2003 polymorphism, you must compile every unit with **polymorphic** specified. If the application does not use polymorphism, specify the **nopolymorphic** suboption; doing so may save compilation time and potentially improve runtime performance.

Related information

See the following information in *XL Fortran Language Reference*:

- Polymorphic entities
- Array constructors

-qxlf2008

Category

Language element control

Purpose

Provides the ability to use language features specific to the Fortran 2008 standard when compiling with compiler invocations that conform to earlier Fortran standards, as well as the ability to disable these features when compiling with compiler invocations that conform to the Fortran 2008 standard.

Syntax

Option:

```
►► -qxlf2008=[checkpresence|nocheckpresence]►►
```

@PROCESS:

```
@PROCESS XLF2008(suboption,suboption,...)
```

Defaults

The default suboption depends on the invocation command that you specify.

The `f2008`, `xlF2008`, `xlF2008_r`, and `xlcuf` CUDA Fortran commands have the following default:

checkpresence

All other invocation commands have the following default:

nocheckpresence

Parameters

checkpresence | **nocheckpresence**

When **checkpresence** is in effect, dummy argument presence is checked according to the Fortran 2008 standard. When **nocheckpresence** is in effect, dummy argument presence is checked according to previous Fortran standards. For more information about dummy argument presence, see Restrictions on optional dummy arguments not present.

Note: When `-qxlf2008=checkpresence` is in effect, the performance of your program is inhibited because of runtime checks for the allocation and association status of actual arguments. To avoid these performance impacts, consider using `-qxlf2008=nocheckpresence`.

-qxlines

Category

Input control

Purpose

Specifies whether fixed source form lines with an X in column 1 are compiled or treated as comments.

This option is similar to the recognition of the character 'd' in column 1 as a conditional compilation (debug) character. The **-qxlines** option recognizes the character 'x' in column 1 as a conditional compilation character when this compiler option is enabled. The 'x' in column 1 is interpreted as a blank, and the line is handled as source code.

Syntax

Option:

►► -q noxl
lines ◀◀

@PROCESS:

@PROCESS XLINES | **NOXLINES**

Defaults

-qnoxlines

This option is set to **-qnoxl**ines by default, and lines with the character 'x' in column 1 in fixed source form are treated as comment lines.

While the `-qxlines` option is independent of `-D`, all rules for debug lines that apply to using 'd' as the conditional compilation character also apply to the conditional compilation character 'x'.

The `-qxlines` compiler option is only applicable to fixed source form.

Usage

The conditional compilation characters 'x' and 'd' may be mixed both within a fixed source form program and within a continued source line. If a conditional compilation line is continued onto the next line, all the continuation lines must have 'x' or 'd' in column 1. If the initial line of a continued compilation statement is not a debugging line that begins with either 'x' or 'd' in column 1, subsequent continuation lines may be designated as debug lines as long as the statement is syntactically correct.

The OMP conditional compilation characters '!\$', 'C\$', and '*\$' may be mixed with the conditional characters 'x' and 'd' both in fixed source form and within a continued source line. The rules for OMP conditional characters will still apply in this instance.

Examples

An example of a base case of `-qxlines`:

```
C2345678901234567890
  program p
    i=3 ; j=4 ; k=5
X   print *,i,j
X   +      ,k
    end program p

<output>: 3 4 5      (if -qxlines is on)
          no output (if -qxlines is off)
```

In this example, conditional compilation characters 'x' and 'd' are mixed, with 'x' on the initial line:

```
C2345678901234567890
  program p
    i=3 ; j=4 ; k=5
X   print *,i,
D   +      j,
X   +      k
    end program p

<output>: 3 4 5 (if both -qxlines and -qdlines are on)
          3 5   (if only -qxlines is turned on)
```

Here, conditional compilation characters 'x' and 'd' are mixed, with 'd' on the initial line:

```
C2345678901234567890
  program p
    i=3 ; j=4 ; k=5
D   print *,i,
X   +      j,
D   +      k
    end program p

<output>: 3 4 5 (if both -qxlines and -qdlines are on)
          3 5   (if only -qdlines is turned on)
```

In this example, the initial line is not a debug line, but the continuation line is interpreted as such, since it has an 'x' in column 1:

```
C2345678901234567890
      program p
      i=3 ; j=4 ; k=5
      print *,i
X     +           ,j
X     +           ,k
      end program p

<output>: 3 4 5 (if -qxlines is on)
          3     (if -qxlines is off)
```

Related information

- “-D” on page 73
- *Conditional compilation in the XL Fortran Language Reference*

-qxref

Category

Listings, messages, and compiler information

Purpose

Produces a compiler listing that includes the cross-reference component of the attribute and cross-reference section of the listing.

Syntax



@PROCESS:

@PROCESS XREF[(FULL)] | NOXREF

Defaults

-qnoxref

Usage

If you specify only **-qxref**, only identifiers that are used are reported. If you specify **-qxref=full**, the listing contains information about all identifiers that appear in the program, whether they are used or not.

If **-qxref** is specified after **-qxref=full**, the full cross-reference listing is still produced.

You can use the cross-reference listing during debugging to locate problems such as using a variable before defining it or entering the wrong name for a variable.

Related information

- “Listings, messages, and compiler information” on page 60
- “Attribute and cross reference section” on page 311

-qzerosize

Category

“Language element control” on page 54

Purpose

Determines whether checking for zero-sized character strings and arrays takes place in programs that might process such objects.

Syntax

►► -q nozerosize
zerosize ◀◀

@PROCESS:

@PROCESS ZEROSIZE | NOZEROSIZE

Defaults

The default setting depends on which command invokes the compiler:

- **-qzerosize** for the **f90**, **xlf90**, **xlf90_r**, **f95**, **xlf95**, **xlf95_r**, **f2003**, **xlf2003**, **xlf2003_r**, **f2008**, **xlf2008**, **xlf2008_r**, and ▶ CUDA Fortran **xlculf** ◀ CUDA Fortran commands
- **-qnozerosize** for the **xlf** and **xlf_r** commands when they are used to compile the **.f**, **.F**, **.f77**, or **.F77** files
- **-qnozerosize** for the **f77** and **fort77** commands

Usage

Use **-qzerosize** for Fortran 90, Fortran 95, Fortran 2003, and Fortran 2008 programs that might process zero-sized character strings and arrays.

For FORTRAN 77 programs, where zero-sized objects are not allowed, or for Fortran 90 and Fortran 95 programs that do not use them, compiling with **-qnozerosize** can improve the performance of some array or character-string operations.

Runtime checking performed by the **-C** option takes slightly longer when **-qzerosize** is in effect.

-r

Category

Object code control

@PROCESS

None.

Purpose

Produces a nonexecutable output file to use as an input file in another ld command call. This file may also contain unresolved symbols.

Syntax

▶— -r —▶

Defaults

Not applicable.

Usage

A file produced with this flag is expected to be used as an input file in another compiler invocation or ld command call.

Predefined macros

None.

Examples

To compile myprogram.f and myprog2.f into a single object file mytest.o, enter:
xlf myprogram.f myprog2.f -r -o mytest.o

-S

Category

Output control

@PROCESS

None.

Purpose

Generates an assembler language file for each source file.

Syntax

▶— -S —▶

Rules

When this option is specified, the compiler produces the assembler source files as output instead of an object or an executable file.

Restrictions

The generated assembler files do not include all the data that is included in a .o file by **-qipa** or **-g**.

Examples

```
xlf95 -O3 -qhot -S test.f           # Produces test.s
```

Related information

The `-o` option can be used to specify a name for the resulting assembler source file.

-t

Category

Compiler customization

@PROCESS

None.

Purpose

Applies the prefix specified by the `-B` option to the designated components.

Syntax



Defaults

The default paths for all of the compiler components are defined in the compiler configuration file.

Parameters

The following table shows the correspondence between `-t` parameters and the component names:

Parameter	Description	Component name
a	The assembler	as
b	The low-level optimizer	xlfcode
c	The compiler front end	xlfentry
d	The disassembler	dis
F	The C preprocessor	cpp
h	The array language optimizer	xlfhot

Parameter	Description	Component name
I (uppercase i)	The high-level optimizer, compile step	ipa
l (lowercase L)	The linker	ld
z	The binder	bolt

Usage

Use this option with the **-B***prefix* option.

Examples

To compile `myprogram.f` so that the name `/u/newones/compilers/` is prefixed to the compiler and assembler program names, enter:

```
xlf myprogram.f -B/u/newones/compilers/ -tca
```

Related information

- “-B” on page 71

-U

Category

Input control

Purpose

Makes the compiler sensitive to the case of letters in names.

Syntax

▶▶ -U ◀◀

@PROCESS:

@PROCESS MIXED | NOMIXED

Defaults

By default, the compiler interprets all names as if they were in lowercase. For example, `abc` and `ABC` are both interpreted as `abc` and so refer to the same object.

Usage

You can use this option when writing mixed-language programs, because Fortran names are all lowercase by default, while names in C and other languages may be mixed-case.

If **-U** is specified, case is significant in names. For example, the names `abc` and `ABC` refer to different objects.

This option changes the link names used to resolve calls between compilation units. It also affects the names of modules and [F2008](#) submodules [F2008](#) and thus the names of their `.mod` and `.smod` files.

Restrictions

The names of intrinsics must be all in lowercase when **-U** is in effect. Otherwise, the compiler may accept the names without errors, but the compiler considers them to be the names of external procedures, rather than intrinsics.

Related information

This is the short form of **-qmixed**. See “-qmixed” on page 191.

-u

Category

Language element control

Purpose

Specifies that no implicit typing of variable names is permitted.

It has the same effect as using the **IMPLICIT NONE** statement in each scope that allows implicit statements.

Syntax

▶▶ -u ◀◀

@PROCESS:

@PROCESS UNDEF | **NOUNDEF**

Defaults

-qnoundef, which allows implicit typing.

Related information

See **IMPLICIT** in the *XL Fortran Language Reference*.

This is the short form of **-qundef**. See “-qundef” on page 258.

-v

Category

Listings, messages, and compiler information

@PROCESS

None.

Purpose

Reports the progress of compilation, by naming the programs being invoked and the options being specified to each program.

Syntax

►► -v ◀◀

Defaults

Not applicable.

Usage

For a particular compilation, examining the output that this option produces can help you determine:

- What files are involved
- What options are in effect for each step
- How far a compilation gets when it fails

Related information

- “-#” on page 70 is similar to -v, but it does not actually execute any of the compilation steps.
- “-V”

-V

Category

Listings, messages, and compiler information

@PROCESS

None.

Purpose

The same as -v except that you can cut and paste directly from the display to create a command.

Defaults

Not applicable.

Syntax

►► -V ◀◀

Related information

- “-v” on page 281
- “-#” on page 70

-W

Category

Listings, messages, and compiler information

@PROCESS

None.

Purpose

Suppresses warning messages (equivalent to `-qflag=e:e`).

Syntax

►► `-w` ◄◄

Defaults

Not applicable.

Related information

- “`-qflag`” on page 132

-W, -X

Category

Compiler customization

@PROCESS

None.

Purpose

Passes one or more options to a component that is executed during compilation.

Syntax

►► `-W` ◄◄

@
a
b
c
d
F
h
I
L
l
n
s
w
x
z

◄◄ `, -option` ►►

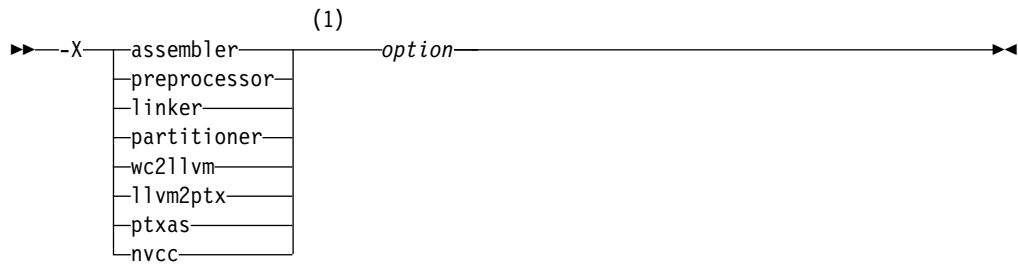

Notes:

- 1 You must insert at least one space before *option*.

Parameters

The following table shows the correspondence between **-X** and **-W** parameters and the component names:

Parameter of -W	Parameter of -X	Description	Component name
> GPU @	ptxas	The PTX assembler	ptxas
a	assembler	The assembler	as
b		The low-level optimizer	xlfcodes
c		The compiler front end	xlfcodes
d		The disassembler	dis
F	preprocessor	The C preprocessor	cpp
h		The array language optimizer	xlfcodes
I (uppercase i)		The high-level optimizer, compile step	ipa
L		The high-level optimizer, link step	ipa
l (lowercase L)	linker	The linker	ld
> GPU n	nvcc	The NVIDIA C compiler, which is used as a device linker	nvcc
> GPU s	partitioner	The XL intermediate language (W-Code) splitter	partitioner
> GPU w	wc2llvm	The XL intermediate language (W-Code) to NVVM-IR translator	wc2llvm
> GPU x	llvm2ptx	The NVVM-IR to PTX translator	llvm2ptx
z		The binder	bolt

option

Any option that is valid for the component to which it is being passed.

Notes: > GPU

- You can find the NVVM-IR to PTX translator options in the libNVVM API section in the CUDA Toolkit documentation at http://docs.nvidia.com/cuda/libnvvm-api/group__compilation.html under `nvvmCompileProgram`.
- You can get a list of the PTX assembler options by running `ptxas` from the CUDA Toolkit with `-h`.

GPU <

Usage

If you need to include a character that is special to the shell in the option string, precede the character with a backslash. For example, if you use the `-W` or `-X` option in the configuration file, you can use the escape sequence backslash comma (`\,`) to represent a comma in the parameter string. In the string following the `-W` option, use a comma as the separator for each option, and do not include any spaces.

You do not need the `-W` or `-X` option to pass most options to the linker `ld`; unrecognized command-line options, except `-q` options, are passed to the linker automatically. Only linker options that have the same letters as compiler options, such as `-v` or `-S`, strictly require `-W` or `-X`.

Examples

> CUDA Fortran

To disable optimization of device code, you can pass options to the NVVM-IR to PTX translator and the PTX assembler by using either of the following commands:

```
xlcuf mycudaprogram.cuf -Xllvm2ptx -nvvm-compile-options=opt=0 -Xptxas -O0  
xlcuf mycudaprogram.cuf -Wx,-nvvm-compile-options=opt=0 -W@,-O0
```

where `-nvvm-compile-options=opt=0` is a NVVM-IR to PTX translator option, and `-O0` is a PTX assembler option.

CUDA Fortran <

Related information

- *Getting Started with CUDA Fortran programming using XL Fortran*

-y

Category

Floating-point and integer control

Purpose

Specifies the rounding mode for the compiler to use when evaluating constant floating-point expressions at compile time.

It is equivalent to the `-qieee` option.

Syntax



@PROCESS:

@PROCESS IEEE(Near | Minus | Plus | Zero)

Defaults

-yn

Parameters

- n Round to nearest.
- m Round toward minus infinity.
- p Round toward plus infinity.
- z Round toward zero.

Usage

If your program contains operations involving real(16) values, the rounding mode must be set to **-yn**, round-to-nearest.

Related information

- “-O” on page 87
- “-qfloat” on page 134
- “-qieee” on page 152

Chapter 7. Compiler commands reference

This section introduces the commands that are included with XL Fortran.

cleanpdf

Purpose

Removes all PDF files or the specified PDF files, including PDF files with process ID suffixes. Removing profiling information reduces runtime overhead if you change the program and then go through the PDF process again.

Syntax

```
►► cleanpdf [pdfdir] [-u] [-f pdfname] ►►
```

Parameters

pdfdir Specifies the directory that contains the PDF files to be removed. If *pdfdir* is not specified, the directory is set by the PDFDIR environment variable; if PDFDIR is not set, the directory is the current directory.

-f *pdfname*

Specifies the name of the PDF file to be removed. If **-f** *pdfname* is not specified, *.<output_name>.pdf* is removed by default, where *<output_name>* is the name of the output file that is generated when you compile your program with **-qpdf1**.

-u

If **-f** *pdfname* is specified, in addition to the file removed by **-f**, files with the naming convention *pdfname.<pid>*, if applicable, are also removed. *<pid>* is the ID of the running process in the PDF training step.

If **-f** *pdfname* is not specified, removes the default PDF file *.<output_name>.pdf*. If applicable, files with the default naming convention *.<output_name>.pdf.<pid>* are also removed.

Usage

Run **cleanpdf** only when you finish the PDF process for a particular application. Otherwise, if you want to resume by using PDF process with that application, you must compile all of the files again with **-qpdf1**.

You can find **cleanpdf** in */opt/ibm/xlf/15.1.5/bin/*.

Related information

- “-qpdf1, -qpdf2” on page 202
- "Profile-directed feedback" in the *XL Fortran Optimization and Programming Guide*
- Correct settings for environment variables

genhtml

Purpose

Displays the HTML version of an XML report that has already been generated.

Usage

Use the following command to view the existing XML report in HTML format. This command generates the HTML content to standard output.

```
genhtml xml_file
```

Use the following command to generate the HTML content into a defined HTML file. You can use a web browser to view the generated HTML file.

```
genhtml xml_file > target_html_file
```

Note: The suffix of the HTML file name must be compliant with the static HTML page standard, for example, .html or .htm. Otherwise, the web browser might not be able to open the file.

Related information

- “-qlistfmt” on page 181

mergepdf

Purpose

Merges two or more PDF files into a single PDF file.

Syntax

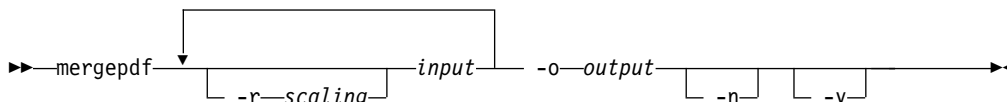

Parameters

-r *scaling*

Specifies the scaling ratio for the PDF file. This value must be greater than zero and can be either an integer or a floating-point value. If not specified, a ratio of 1.0 is assumed.

input Specifies the name of a PDF input file, or a directory that contains PDF files.

-o *output*

Specifies the name of the PDF output file, or a directory to which the merged output is written.

-n Specifies that PDF files do not get normalized.

-v Specifies verbose mode, and causes internal and user-specified scaling ratios to be displayed to standard output.

Usage

By default, **mergepdf** normalizes the files in such a way that every profile has the same overall weighting, and individual counters are scaled accordingly. This procedure is done before applying the user-specified ratio (with **-r**). When **-n** is specified, no normalization occurs. If neither **-n** nor **-r** is specified, the PDF files are not scaled at all.

You can find **mergepdf** in `/opt/ibm/xlf/15.1.5/bin/`.

Example

If you have several PDF files, use the **mergepdf** command to combine these PDF files into one PDF file. For example, if you produce three PDF files that represent usage patterns that occur 53%, 32%, and 15% of the time respectively, you can use this command:

```
mergepdf -r 53 file_path1 -r 32 file_path2 -r 15 file_path3 -o file_path4
```

where *file_path1*, *file_path2*, and *file_path3* specify the directories and names of the PDF files that are to be merged, and *file_path4* specifies the directory and name of the output PDF file.

Related information

- “-qpdf1, -qpdf2” on page 202
- "Profile-directed feedback" in the *XL Fortran Optimization and Programming Guide*

showpdf

Purpose

Displays part of the profiling information written to PDF and PDF map files. To use this command, you must first compile your program with the **-qpdf1** option.

Syntax

```
→ showpdf [pdfdir] [-f pdfname] [-m pdfmapdir] [-xml]
```

Parameters

pdfdir

Is the directory that contains the profile-directed feedback (PDF) file. If the PDFDIR environment variable is not changed after the PDF1 step, the PDF map file is also contained in this directory. If this parameter is not specified, the compiler uses the value of the PDFDIR environment variable as the name of the directory.

pdfname

Is the name of the PDF file. If this parameter is not specified, the compiler uses `.<output_name>.pdf` as the name of the PDF file by default, where `<output_name>` is the name of the output file that is generated when you compile your program with **-qpdf1**.

pdfmapdir

Is the directory that contains the PDF map file. If this parameter is not specified, the compiler uses the value of the PDFDIR environment variable as the name of the directory.

-xml

Determines the display format of the PDF information. If this parameter is specified, the PDF information is displayed in XML format; otherwise, it is displayed in text format. Because value profiling and cache-miss profiling information can be displayed only in XML format, the PDF report in XML format contains more information than the report in text format.

Usage

A PDF map file that contains static information is generated during the PDF1 step and a PDF file is generated during the execution of the resulting application. With the **showpdf** command, you can view the following types of profiling information that is gathered from your application:

- Block-counter profiling
- Call-counter profiling
- Value profiling
- Cache-miss profiling, if you specified the **-qpdf1=level=2** option during the PDF1 step.

The **showpdf** command accepts only PDF files that are in binary format and needs both the PDF and PDF map files to display PDF information. You can view the first two types of profiling information in either text or XML format. However, you can view value profiling and cache-miss profiling information only in XML format.

If the PDFDIR environment variable is changed between the PDF1 step and the execution of the resulting application, the PDF and PDF map files are generated in separate directories. In this case, you must specify the directories for both of these files to the **showpdf** command.

You can find **showpdf** in `/opt/ibm/xlf/15.1.5/bin/`.

Example

The following example shows how to use the **showpdf** command to view the profiling information for a Hello World application.

The source for the program file `hello.f` is as follows:

```
PROGRAM P
  CALL HelloWorld()

CONTAINS

  SUBROUTINE HelloWorld()
    PRINT *, "Hello World"
  END SUBROUTINE HelloWorld

END PROGRAM P
END
```

1. Compile the source file.

```
xlf2008 -qpdf1 -o hello.f
```
2. Run the resulting executable program with a typical data set or several typical data sets.

3. If you want to view the profiling information for the executable file in text format, run the **showpdf** command without any parameters.

```
showpdf
```

The result is as follows:

```
...
-----
p(63): 1 (hello.f)

Call Counters:
2 | 1 @2@helloworld(64)
2 | 1 _xlfExit(65)

Call coverage = 100% ( 2/2 )

Block Counters:
1-10 | 1
10 |

Block coverage = 100% ( 1/1 )

-----
@2@helloworld(64): 1 (hello.f)

Call Counters:
7 | 1 _xlfBeginIO(66)
7 | 1 _xlfWriteLDChar(67)
7 | 1 _xlfEndIO(68)

Call coverage = 100% ( 3/3 )

Block Counters:
6-7 | 1
8 |
8 | 1

Block coverage = 100% ( 2/2 )

-----
_xlfExit(65): 1 undefined node

-----
_xlfBeginIO(66): 1 undefined node

-----
_xlfWriteLDChar(67): 1 undefined node

-----
_xlfEndIO(68): 1 undefined node

Total Call coverage = 100% ( 5/5 )

Total Block coverage = 100% ( 3/3 )
```

If you want to view the profiling information in XML format, run the **showpdf** command with the **-xml** parameter.

```
showpdf -xml
```

The result is as follows:

```
<?xml version="1.0" encoding="UTF-8" ?>
- <XLTransformationReport xmlns="http://www.ibm.com/2010/04/CompilerTransformation" version="1.0">
  - <CompilationStep name="showpdf">
    <StepDetails>
      ...
```

```

<Detail>
  <FieldTitle>Total Call coverage</FieldTitle>
  <FieldValue>100% ( 5/5 )</FieldValue>
</Detail>
<Detail>
  <FieldTitle>Total Block coverage</FieldTitle>
  <FieldValue>100% ( 3/3 )</FieldValue>
</Detail>
</StepDetails>
<ProgramHierarchy>
  <FileList>
    <File id="1" name="hello.f">
      <RegionList>
        <Region id="63" name="p" startLineNumber="1"/>
        <Region id="64" name="@2@helloworld" startLineNumber="6"/>
      </RegionList>
    </File>
  </FileList>
</ProgramHierarchy>
<TransformationHierarchy/>
<ProfilingReports>
  <BlockCounterList>
    <BlockCounter regionId="63" execCount="1" coveredBlock="1" totalBlock="1">
      <BlockList>
        <Block index="3" execCount="1" startLineNumber="1" endLineNumber="10"/>
      </BlockList>
    </BlockCounter>
    <BlockCounter regionId="64" execCount="1" coveredBlock="2" totalBlock="2">
      <BlockList>
        <Block index="3" execCount="1" startLineNumber="6" endLineNumber="7"/>
        <Block index="4" execCount="1" startLineNumber="8" endLineNumber="8"/>
      </BlockList>
    </BlockCounter>
  </BlockCounterList>
  <CallCounterList>
    <CallCounter regionId="63" execCount="1" coveredCall="2" totalCall="2">
      <CallList>
        <Call name="@2@helloworld" execCount="1" lineNumber="2"/>
        <Call name="_xlfExit" execCount="1" lineNumber="2"/>
      </CallList>
    </CallCounter>
    <CallCounter regionId="64" execCount="1" coveredCall="3" totalCall="3">
      <CallList>
        <Call name="_xlfBeginIO" execCount="1" lineNumber="7"/>
        <Call name="_xlfWriteLDChar" execCount="1" lineNumber="7"/>
        <Call name="_xlfEndIO" execCount="1" lineNumber="7"/>
      </CallList>
    </CallCounter>
  </CallCounterList>
</ProfilingReports>
</CompilationStep>
</XLTransformationReport>

```

Related information

- “-qpdf1, -qpdf2” on page 202
- “-qshowpdf” on page 227
- "Profile-directed feedback" in the *XL Fortran Optimization and Programming Guide*

Chapter 8. Using XL Fortran in a 64-bit environment

The 64-bit environment addresses an increasing demand for larger storage requirements and greater processing power. The Linux operating system provides an environment that allows you to develop and execute programs that exploit 64-bit processors through the use of 64-bit address space.

Chapter 9. Tracking compiler license usage

You can enable IBM Software License Metric (SLM) Tags logging to track compiler license usage. This information can help you determine whether your organization's use of the compiler exceeds your compiler license entitlements.

Understanding compiler license tracking

You can enable IBM Software License Metric (SLM) Tags logging in the compiler so that IBM License Metric Tool (ILMT) can track compiler license usage.

Types of compiler licenses logged

The compiler logs the usage of the following two types of compiler licenses:

- **Authorized user licenses:** Each compiler license is tied to a specific user ID, designated by that user's uid.
- **Concurrent user licenses:** A certain number of concurrent users are authorized to use the compiler license at any given time.

The compiler logs each compiler invocation as either a concurrent user or an authorized user invocation, depending on the presence of the invoking user's uid in a file that lists the authorized users.

The SLM daemon process

The SLM tag file is created by the SLM daemon. The SLM daemon is a regular executable in the compiler. It outputs a tag file for every user-defined period of time. The daemon terminates if no user invokes the compiler within a user-defined period of time, and restarts with a new invocation of the compiler. You can define both time periods in the configuration file.

The SLM tag file

The compiler logs compiler license usage to an SLM tag file *slm_dir/hash.slmtags*, where *slm_dir* is a configurable directory, and *hash* is the MD5 hash of the SWID and root directory of the current product. The default value of *slm_dir* is */var/opt/ibm/xl-compiler/* for a default installation, or *\$prefix/var/opt/ibm/xl-compiler* for a nondefault installation, where *\$prefix* is the nondefault installation path. The *slm_dir* directory must be readable and writable by all users invoking the compiler.

The main elements of the tag file are as follows:

<StartTime> and <EndTime>

The start time and end time of the invocations.

<Value>

The maximum number of users that invoked the compiler simultaneously within the time period denoted by the **<StartTime>** and **<EndTime>** elements.

<Type>

The type of compiler license logged.

<Metric>

All the preceding elements are contained in the <Metric> element. The SLM daemon outputs up to two <Metric> elements for every time period, one for authorized users and one for concurrent users.

The following example is a tag file generated by the compiler. It logs three concurrent user invocations followed by one authorized user invocation.

```
<SchemaVersion>2.1.1</SchemaVersion>
<SoftwareIdentity>
  <PersistentId>0bce7313f2a24da7b1b27f33294ffe70</PersistentId>
  <Name>IBM XL Fortran for Linux</Name>
  <InstanceId>/opt/ibm/xlC/15.1.5</InstanceId>
</SoftwareIdentity>
<Metric logTime="2016-04-01T18:39:51Z">
  <Type>AUTHORIZED_USER</Type>
  <Value>1</Value>
  <Period>
    <StartTime>2016-04-01T18:34:51Z</StartTime>
    <EndTime>2016-04-01T18:39:51Z</EndTime>
  </Period>
</Metric>
<Metric logTime="2016-04-01T18:39:51Z">
  <Type>CONCURRENT_USER</Type>
  <Value>3</Value>
  <Period>
    <StartTime>2016-04-01T18:14:51Z</StartTime>
    <EndTime>2016-04-01T18:19:51Z</EndTime>
  </Period>
</Metric>
```

The tag file has a configurable size limit and the default is 5,000,000 bytes. If the size of the current file exceeds the maximum size, old <Metric> elements in the file are removed.

Error logs

If an error occurs before the daemon forks, a return code of -1 is returned. Otherwise, no failure will be reported. In either case, the error will be logged to *slm_dir/.hash/log*.

Related reference:

-qslmtags

Related information:

Configuring file attributes

Setting up SLM Tags logging

To enable ILMT to track compiler usage, you must set up SLM Tags logging.

About this task

If your compiler license is an authorized user license, use these steps to set up XL compiler SLM Tags logging.

Procedure

1. Determine the user IDs of your authorized users.
2. Create a file with the name `XLAuthorizedUsers` in the `/etc` directory. You can change the location of the `XLAuthorizedUsers` file by specifying the `slm_auth` attribute of the configuration file. The file contains the information for

authorized users, one line for each user. Each line contains the numeric uid of the authorized user followed by a comma, and the Software ID (SWID) of the authorized product.

You can obtain the uid of a user ID by using the `id -u username` command, where you replace *username* with the user ID you are looking up.

You can find the SWID of the product by running the following command:

```
grep persistentId /opt/ibm/xlf/V.R.M/swidtag/*.swidtag
```

where *V.R.M* is the Version.Release.Modification level of the compiler that is installed on the system.

3. Set `/etc/XLAuthorizedUsers` to be readable by all users invoking the compiler:

```
chmod a+r /etc/XLAuthorizedUsers
```

Results

If a user's uid is listed in `/etc/XLAuthorizedUsers`, the compiler will log an authorized user invocation along with the SWID of the compiler being used. Otherwise the compiler will log a concurrent user invocation.

Note that XL compiler SLM Tags logging does not enforce license compliance. It only logs compiler invocations so that you can use the collected data and IBM License Metric Tool to determine whether your use of the compiler is within the terms of your compiler license.

Example

Suppose that you have three authorized users whose IDs are `bsmith`, `rsingh`, and `jchen`. For these user IDs you enter the following commands and see the corresponding output in a command shell:

```
$id -u bsmith
24461
$id -u rsingh
9204
$id -u jchen
7531
```

You run the following command to obtain the SWID:

```
$ grep persistentId /opt/ibm/xlf/15.1.5/swidtag/*.swidtag
<Meta persistentId="0bce7313f2a24da7b1b27f33294ffe70"/>
```

Then you create `/etc/XLAuthorizedUsers` with the following lines to authorize these users to use the compiler:

```
24461,0bce7313f2a24da7b1b27f33294ffe70
9204,0bce7313f2a24da7b1b27f33294ffe70
7531,0bce7313f2a24da7b1b27f33294ffe70
```

Related reference:

`-qslmtags`

Related information:

 [IBM License Metric Tool \(ILMT\)](#)

Configuration file attributes

Chapter 10. Problem determination and debugging

This section describes some methods you can use for locating and fixing problems in compiling or executing your programs.

Understanding XL Fortran error messages

Most information about potential or actual problems comes through messages from the compiler or application program. These messages are written to the standard error stream.

Error severity

Compilation errors can have the following severity levels (from the highest to the lowest):

- U** An unrecoverable error. Compilation failed because of an internal compile-time error.
- S** A severe error. Compilation failed due to one of the following:
 - An unrecoverable program error has been detected. Processing of the source file stops, and XL Fortran does not produce an object file. You can usually correct this error by fixing any program errors that were reported during compilation.
 - Conditions exist that the compiler could not correct. An object file is produced; however, you should not attempt to run the program.
 - An internal compiler table has overflowed. Processing of the program stops, and XL Fortran does not produce an object file.
 - An include file does not exist. Processing of the program stops, and XL Fortran does not produce an object file.
- E** An error that the compiler can correct. The program should run correctly.
- W** Warning message. It does not signify an error but may indicate some unexpected condition.
- L** Warning message that was generated by one of the compiler options that check for conformance to various language levels. It may indicate a language feature that you should avoid if you are concerned about portability.
- I** Informational message. It does not indicate any error, just something that you should be aware of to avoid unexpected behavior or to improve performance.

Note:

- The message levels **S** and **U** indicate a compilation failure.
- The message levels **I**, **L**, **W**, and **E** do not indicate a compilation failure.

By default, the compiler stops without producing output files if it encounters a severe error (severity **S**). However, you can control how the messages are generated by using the following options:

- You can make the compiler stop for less severe errors by specifying a different severity with the **-qhalt** option. For example, with **-qhalt=e**, the compiler stops if

it encounters any errors of severity E or higher severity. This technique can reduce the amount of compilation time that is needed to check the syntactic and semantic validity of a program.

- You can limit low-severity messages without stopping the compiler by using the **-qflag** option.
- You can stop compilation when a specified error message is generated by using the **-qhaltonmsg** option.
- You can stop compilation when a specified number of errors of a specified minimum severity level is reached by using the **-qmaxerr** option.
- If you simply want to prevent specific messages from going to the output stream, see **-qsuppress**.

Compiler return codes

The compiler return codes and their respective meanings are as follows:

- 0 The compiler did not encounter any errors severe enough to make it stop processing a compilation unit.
- 1 The compiler encountered an error of severity high enough to halt the compilation. Depending on the level of *halt_severity*, the compiler might have continued processing the compilation units with errors.
- 40 An option error.
- 41 A configuration file error.
- 250 An out-of-memory error. The compiler cannot allocate any more memory for its use.
- 251 A signal received error. An unrecoverable error or interrupt signal is received.
- 252 A file-not-found error.
- 253 An input/output error. Cannot read or write files.
- 254 A fork error. Cannot create a new process.
- 255 An error while executing a process.

Runtime return codes

If an XLF-compiled program ends abnormally, the return code to the operating system is 1.

If the program ends normally, the return code is 0 (by default) or is $\text{MOD}(\text{digit_string}, 256)$ if the program ends because of a **STOP** *digit_string* statement.

Format of XL Fortran diagnostic messages

In addition to the diagnostic message issued, the source line and a pointer to the position in the source line at which the error was detected are printed or displayed if you specify the **-qsource** compiler option. If **-qnosource** is in effect, the file name, the line number, and the column position of the error are displayed with the message.

The format of an XL Fortran diagnostic message is:

```

▶▶—15—cc—--nnn— ———┌—————┐—————▶
                       | (—severity_letter—) | message_text

```

where:

- 15 Indicates an XL Fortran message

cc Is the component number, as follows:

- 00 Indicates a code generation or optimization message
- 01 Indicates an XL Fortran common message
- 11-20 Indicates a Fortran-specific message
- 25 Indicates a runtime message from an XL Fortran application program
- 85 Indicates a loop-transformation message
- 86 Indicates an interprocedural analysis (IPA) message
- 87 Indicates a runtime message from the SMP library

nnn Is the message number

severity_letter
Indicates how serious the problem is, as described in the preceding section

'message text'
Is the text describing the error

Limiting the number of compile-time messages

If the compiler issues many low-severity (I or W) messages concerning problems you are aware of or do not care about, use the **-qflag** option or its short form **-w** to limit messages to high-severity ones:

```
# E, S, and U messages go in listing; U messages are displayed on screen.
xlf95 -qflag=e:u program.f
```

```
# E, S, and U messages go in listing and are displayed on screen.
```

```
xlf95 -w program.f
```

Fixing installation or system environment problems

If individual users or all users on a particular machine have difficulty running the compiler, there may be a problem in the system environment. Here are some common problems and solutions:

A compilation fails with an I/O error.

System action:

The compilation fails with an I/O error.

User response:

Increase the size of the /tmp filesystem, or set the environment variable **TMPDIR** to the path of a filesystem that has more free space.

Explanation:

The object file may have grown too large for the filesystem that holds it. The cause could be a very large compilation unit or initialization of all or part of a large array in a declaration.

Could not load program *program*

Message:

```
Could not load program program
Error was: not enough space
```

System action:

The system cannot execute the compiler or an application program at all.

User response:

Set the storage limits for stack and data to “unlimited” for users who experience this problem. For example, you can set both your hard and soft limits with these **bash** commands:

```
ulimit -s unlimited
ulimit -d unlimited
```

Or, you may find it more convenient to edit the file `/etc/security/limits.conf` to give all users unlimited stack and data segments (by entering -1 for these fields).

If the storage problem is in an XLF-compiled program, using the **-qsave** or **-qsmallstack** option might prevent the program from exceeding the stack limit.

Explanation:

The compiler allocates large internal data areas that may exceed the storage limits for a user. XLF-compiled programs place more data on the stack by default than in previous versions, also possibly exceeding the storage limit. Because it is difficult to determine precise values for the necessary limits, we recommend making them unlimited.

Could not load library *library_name***Message:**

```
Could not load library library_name.so
Error was: no such file or directory
```

User response:

Make sure the XL Fortran libraries are installed in `/opt/ibm/xlf/15.1.5/lib`, or set the **LD_RUN_PATH** environment variables to include the directory where **libxlf90.so** is installed if it is in a different directory. See “Setting library search paths” on page 8 for details of this environment variable.

Internal compiler error**System action:**

The compilation fails with an internal compiler error.

User response:

Try increasing the stack size. For example, you can set both your hard and soft limits with the **ulimit bash** command or edit the file `/etc/security/limits.conf` to modify the stack segment. If the error still occurs after you increase the stack size, you must take other measures.

Note: Only some internal compiler errors are caused by the limited stack size. An example scenario where such an internal compiler error might occur is when you compile a program that reads module symbol files in which large derived types are defined.

invocation_command*: not found*System action:**

The shell cannot locate the command to execute the compiler.

User response:

Make sure that your **PATH** environment variable includes the directory `/opt/ibm/xlf/15.1.5/bin`. If the compiler is properly installed, the commands you need to execute it are in this directory.

Too many individual makefiles and compilation scripts**System action:**

There are too many individual makefiles and compilation scripts to easily maintain or track.

User response:

Add stanzas to the configuration file, and create links to the compiler by using the names of these stanzas. By running the compiler with different command names, you can provide consistent groups of compiler options and other configuration settings to many users.

Fixing compile-time problems

The following sections discuss common problems you might encounter while compiling and how to avoid them.

Duplicating extensions from other systems

Some ported programs may cause compilation problems because they rely on extensions that exist on other systems. XL Fortran supports many extensions like these, but some require compiler options to turn them on. See “Portability and migration” on page 66 for a list of these options and *Porting programs to XL Fortran* in the *XL Fortran Optimization and Programming Guide* for a general discussion of porting.

Isolating problems with individual compilation units

If you find that a particular compilation unit requires specific option settings to compile properly, you may find it more convenient to apply the settings in the source file through an **@PROCESS** directive. Depending on the arrangement of your files, this approach may be simpler than recompiling different files with different command-line options.

Compiling with threadsafe commands

Threadsafe invocation commands like `xlf_r` or `xlf90_r`, for example, use different search paths and call different modules than the non threadsafe invocations. Your programs should account for the different usages. Programs that compile and run successfully for one environment may produce unexpected results when compiled and run for a different use. The configuration file, `xlf.cfg`, shows the paths, libraries, and so on for each invocation command. (See “Editing the default configuration file” on page 14 for an explanation of its contents.)

Running out of machine resources

If the operating system runs low on resources (page space or disk space) while one of the compiler components is running, you should receive one of the following messages:

1501-229 Compilation ended because of lack of space.

1517-011 Compilation ended. No more system resources available.

1501-053 (S) Too much initialized data.
1501-511. Compilation failed for file [filename].

You may need to increase the system page space and recompile your program. See the man page information **man 8 mkswap swapon** for more information about page space.

If your program produces a large object file, for example, by initializing all or part of a large array, you may need to do one of the following:

- Increase the size of the filesystem that holds the /tmp directory.
- Set the **TMPDIR** environment variable to a filesystem with a lot of free space.
- For very large arrays, initialize the array at run time rather than statically (at compile time).

Compilation failure because of internal alias table overflow

At an optimization level of **-O2** or higher, XL Fortran compiler computes alias information to ensure that the optimizer preserves the semantics of the application. Alias computation might be an expensive process in terms of space usage, depending on the object definitions and language constructs used in an application. In rare occasions, the internal alias table might overflow, which causes the compilation to fail. Such overflow might occur when a module defines or uses derived-type objects that contain a large number of ultimate components, and passes the objects as dummy arguments to a large number of procedures that are defined in the same module. Partitioning the set of module procedures and placing each partition in a separate module might resolve the overflow problem.

Fixing link-time problems

After the XL Fortran compiler processes the source files, the linker links the resulting object files together. Any messages issued at this stage come from the **ld** command. A frequently encountered error and its solution are listed here for your convenience:

Undefined or unresolved symbols detected

Message:

```
filename.o(.text+0x14): undefined reference to "p"  
filename.o(.text+0x14): relocation truncated to fit: R_PPC_REL24 p
```

System action:

A program cannot be linked because of unresolved references.

Explanation:

Either needed object files or libraries are not being used during linking, there is an error in the specification of one or more external names, or there is an error in the specification of one or more procedure interfaces.

User response:

You may need to do one or more of the following actions:

- Compile again with the **-WI**, or **-M** option to create a file that contains information about undefined symbols.
- Make sure that if you use the **-U** option, all intrinsic names are in lowercase.

Fixing runtime problems

XL Fortran issues error messages during the running of a program in either of the following cases:

- XL Fortran detects an input/output error. “Setting runtime options” on page 37 explains how to control these kinds of messages.
- XL Fortran detects an exception error, and the default exception handler is installed (through the **-qsigtrap** option or a call to **SIGNAL**). To get a more descriptive message than Core dumped, you may need to run the program from within **gdb**.

The causes for runtime exceptions are listed in “XL Fortran runtime exceptions” on page 48.

You can investigate errors that occur during the execution of a program by using a symbolic debugger, such as **gdb**.

Duplicating extensions from other systems

Some ported programs may not run correctly if they rely on extensions that are found on other systems. XL Fortran supports many such extensions, but you need to turn on compiler options to use some of them. See “Portability and migration” on page 66 for a list of these options and *Porting programs to XL Fortran* in the *XL Fortran Optimization and Programming Guide* for a general discussion of porting.

Mismatched sizes or types for arguments

Arguments of different sizes or types might produce incorrect execution and results. To do the type-checking during the early stages of compilation, specify interface blocks for the procedures that are called within a program.

Working around problems when optimizing

If you find that a program produces incorrect results when it is optimized and if you can isolate the problem to a particular variable, you might be able to work around the problem temporarily by declaring the variable as **VOLATILE**. This prevents some optimizations that affect the variable. (See **VOLATILE** in the *XL Fortran Language Reference*.) Because this is only a temporary solution, you should continue debugging your code until you resolve your problem, and then remove the **VOLATILE** keyword. If you are confident that the source code and program design are correct and you continue to have problems, contact your support organization to help resolve the problem.

Input/Output errors

If the error detected is an input/output error and you have specified **IOSTAT** on the input/output statement in error, the **IOSTAT** variable is assigned a value according to *Conditions and IOSTAT values* in the *XL Fortran Language Reference*.

If you have installed the XL Fortran runtime message catalog on the system on which the program is executing, a message number and message text are issued to the terminal (standard error) for certain I/O errors. If you have specified **IOMSG** on the input/output statement, the **IOMSG** variable is assigned the error message text if an error is detected, or the content of **IOMSG** variable is not changed. If this catalog is not installed on the system, only the message number appears. Some of the settings in “Setting runtime options” on page 37 allow you to turn some of these error messages on and off.

If a program fails while writing a large data file, you may need to increase the maximum file size limit for your user ID. You can do this through a shell command, such as `ulimit` in `bash`.

Tracebacks and core dumps

If a runtime exception occurs and an appropriate exception handler is installed, a message and a traceback listing are displayed. Depending on the handler, a core file might be produced as well. You can then use a debugger to examine the location of the exception.

To produce a traceback listing without ending the program, call the `xl__trbk` procedure:

```
IF (X .GT. Y) THEN      ! X > Y indicates that something is wrong.
  PRINT *, 'Error - X should not be greater than Y'
  CALL XL__TRBK        ! Generate a traceback listing.
END IF
```

See *Installing an exception handler* in the *XL Fortran Optimization and Programming Guide* for instructions about exception handlers and “XL Fortran runtime exceptions” on page 48 for information about the causes of runtime exceptions.

Debugging a Fortran program

You can use `gdb` and other symbolic debuggers to debug your programs. For instructions on using your chosen debugger, consult the online help within the debugger or its documentation.

Always specify the `-g` option when compiling programs for debugging.

Note: Debugging Fortran 2003 polymorphic objects and parameterized derived types is not supported in this release of XL Fortran.

Related information:

- “Error checking and debugging” on page 58

Chapter 11. Understanding XL Fortran compiler listings

Diagnostic information is placed in the output listing produced by the **-qlist**, **-qsource**, **-qxref**, **-qattr**, **-qreport**, and **-qlistopt** compiler options. The **-S** option generates an assembler listing in a separate file.

To locate the cause of a problem with the help of a listing, you can refer to the following:

- The source section (to see any compilation errors in the context of the source program)
- The attribute and cross-reference section (to find data objects that are misnamed or used without being declared or to find mismatched parameters)
- The transformation and object sections (to see if the generated code is similar to what you expect)

A heading identifies each major section of the listing. A string of greater than symbols precedes the section heading so that you can easily locate its beginning:

```
>>>> SECTION NAME <<<<<<
```

You can select which sections appear in the listing by specifying compiler options.

Related information

- “Listings, messages, and compiler information” on page 60

Header section

The listing file has a header section that contains the following items:

- A compiler identifier that consists of the following elements:
 - Compiler name
 - Version number
 - Release number
 - Modification number
 - Fix number
- Source file name
- Date of compilation
- Time of compilation

The header section is always present in a listing; it is the first line and appears only once. The following sections are repeated for each compilation unit when more than one compilation unit is present.

Options section

The options section is always present in a listing. There is a separate section for each compilation unit. It indicates the specified options that are in effect for the compilation unit. This information is useful when you have conflicting options. If you specify the **-qlistopt** compiler option, this section lists the settings for all options.

Source section

The source section contains the input source lines with a line number and, optionally, a file number. The file number indicates the source file (or include file) from which the source line originated. All main file source lines (those that are not from an include file) do not have the file number printed. Each include file has a file number associated with it, and source lines from include files have that file number printed. The file number appears on the left, the line number appears to its right, and the text of the source line is to the right of the line number. XL Fortran numbers lines relative to each file. The source lines and the numbers that are associated with them appear only if the **-qsource** compiler option is in effect. You can selectively print parts of the source by using the **@PROCESS** directives **SOURCE** and **NOSOURCE** throughout the program.

Error messages

If the **-qsource** option is in effect, the error messages are interspersed with the source listing. The error messages that are generated during the compilation process contain the following elements:

- The source line
- A line of indicators that point to the columns that are in error
- The error message, which consists of the following elements:
 - The 4-digit component number
 - The number of the error message
 - The severity level of the message
 - The text that describes the error

For example:

```
          2 |          equivalence (i,j,i,j)
          .....a.b.
a - "t.f", line 2.24: 1514-117 (E) Same name appears more than once in an equivalence group.
b - "t.f", line 2.26: 1514-117 (E) Same name appears more than once in an equivalence group.
```

If the **-qnosource** option is in effect, the error messages are all that appear in the source section, and an error message contains:

- The file name in quotation marks
- The line number and column position of the error
- The error message, which consists of the following elements:
 - The 4-digit component number
 - The number of the error message
 - The severity level of the message
 - The text that describes the error

For example:

```
"doc.f", line 6.11: 1513-039 (S) Number of arguments is not
permitted for INTRINSIC function abs.
```

PDF report section

The following sections of the listing report have been added to help you analyze some aspects of your programs. When using the **-qreport** option with the **-qpdf2** option, you can get the following additional sections added to the listing report in the section entitled PDF Report:

Loop iteration count

The most frequent loop iteration count and the average iteration count, for

a given set of input data, is calculated for most loops in a program. This information is only available when the program is compiled at optimization level -O5.

Block and call count

This section covers the *Call Structure* of the program and the respective execution count for each called function. It also includes *Block information* for each function. For non-user defined functions, only execution count is given. The Total Block and Call Coverage, and a list of the user functions ordered by decreasing execution count are printed in the end of this report section. In addition, the Block count information is printed at the beginning of each block of the pseudo-code in the listing files.

Cache miss

This section is printed in a single table. It reports the number of *Cache Misses* for certain functions, with additional information about the functions such as: Cache Level, Cache Miss Ratio, Line Number, File Name, and Memory Reference.

Note: You must use the `-qpdf1=level=2` option to get this report. You can also select the level of cache to profile using the `PDF_PM_EVENT` environment variable during run time.

Relevance of profiling data

This section includes the relevance between the source code during the PDF1 step and the profiling data. The relevance is indicated by a number in the range of 0 - 100. The larger the number is, the more relevant the profiling data is to the source code, and the more performance gain can be achieved by using the profiling data.

Missing profiling data

This section might include a warning message about missing profiling data. The warning message is issued for each function for which the compiler does not find profiling data.

Outdated profiling data

This section might include a warning message about outdated profiling data. The compiler issues this warning message for each function that is modified after the PDF1 step. The warning message is also issued when the optimization levels are different between the PDF1 and PDF2 steps.

For detailed information about the profile-directed feedback, see "Profile-directed feedback" in the *XL Fortran Optimization and Programming Guide*.

For additional information about the listing files, see "Understanding XL Fortran compiler listings" in the *XL Fortran Compiler Reference*.

Transformation report section

If the `-qreport` option is in effect, a transformation report listing shows how IBM XL Fortran for Linux, V15.1.5 optimized the program. This LOOP TRANSFORMATION section displays pseudo-Fortran code that corresponds to the original source code, so that you can see parallelization and loop transformations that the `-qhot` or `-qsmp` options have generated. This section of the report also shows information on the additional transformations and parallelization performed on loop nests if you compile with `-qsmp` and `-qhot=level=2`.

The compiler also reports the number of streams created for a given loop. You can use this information to understand your application code and to tune your code for better performance. For example, you can distribute a loop which has more streams than the number supported by the underlying architecture.

To generate information about where the compiler inserted data prefetch instructions, use the optimization level of **-qhot**, **-O3**, **-O4** or **-O5** together with **-qreport**.

Sample Report

The following report was created for the program **t.f** using the **xlf -qhot -qreport t.f**

command.

Program t.f:

```
integer a(100, 100)
integer i,j

do i = 1 , 100
  do j = 1, 100
    a(i,j) = j
  end do
end do
end
```

Transformation Report:

>>>> SOURCE SECTION <<<<<

** _main === End of Compilation 1 ===

>>>> LOOP TRANSFORMATION SECTION <<<<<

```
PROGRAM _main ()
4|      IF (.FALSE.) GOTO lab_9
      @CIV2 = 0
  Id=1  DO @CIV2 = @CIV2, 24
5|      IF (.FALSE.) GOTO lab_11
      @LoopIV1 = 0
6|      @CSE0 = @CIV2 * 4
      @ICM0 = @CSE0 + 1
      @ICM1 = @CSE0 + 2
      @ICM2 = @CSE0 + 3
      @ICM3 = @CSE0 + 4
5|Id=2  DO @LoopIV1 = @LoopIV1, 99
      ! DIR_INDEPENDENT loopId = 0
      ! DIR_INDEPENDENT loopId = 0
6|      @CSE1 = @LoopIV1 + 1
      SHADV_M003_a(@CSE1,@ICM0) = @ICM0
      SHADV_M002_a(@CSE1,@ICM1) = @ICM1
      SHADV_M001_a(@CSE1,@ICM2) = @ICM2
      SHADV_M000_a(@CSE1,@ICM3) = @ICM3
7|      ENDDO
      lab_11
8|      ENDDO
      lab_9
4|      IF (.FALSE.) THEN
      @LoopIV0 = int((100 - MOD(100, int(4))))
  Id=5  DO @LoopIV0 = @LoopIV0, 100
5|      IF (.FALSE.) GOTO lab_19
      @LoopIV1 = 0
6|      @ICM4 = @LoopIV0 + 1
```

```

5|Id=6          DO @LoopIV1 = @LoopIV1, 99
                ! DIR_INDEPENDENT loopId = 0
                ! DIR_INDEPENDENT loopId = 0
6|              a((@LoopIV1 + 1),@ICM4) = @ICM4
7|              ENDDO
                lab_19
8|              ENDDO
                ENDIF
9|              END PROGRAM _main

```

Source File	Source Line	Loop Id	Action / Information
0	4	1	Loop interchanging applied to loop nest.
0	4	1	Outer loop has been unrolled 4 time(s).

Data reorganization report section

A summary of useful information about how program variable data gets reorganized by the compiler, *data reorganizations*.

To generate data reorganization information, specify the optimization level **-qipa=level=2** or **-O5** together with **-qreport**. During the IPA link pass, the data reorganization messages for program variable data is produced to the data reorganization section of the listing file. Reorganization includes:

- common block splitting
- array splitting
- array transposing
- memory allocation merging
- array interleaving
- array coalescing

Attribute and cross reference section

This section provides information about the entities that are used in the compilation unit. It is present if the **-qxref** or **-qattr** compiler option is in effect. Depending on the options in effect, this section contains all or part of the following information about the entities that are used in the compilation unit:

- Names of the entities
- Attributes of the entities (if **-qattr** is in effect). Attribute information may include any or all of the following details:
 - The class of the name
 - The type
 - The relative address of the name
 - Alignment
 - Dimensions
 - For an array, whether it is allocatable
 - Whether it is a pointer, target, or integer pointer
 - Whether it is a parameter
 - Whether it is volatile
 - For a dummy argument, its intent, whether it is value, and whether it is optional
 - For a module entity, whether it is private, public, or protected
- Coordinates to indicate where you have defined, referenced, or modified the entities. If you declared the entity, the coordinates are marked with a \$. If you initialized the entity, the coordinates are marked with a *. If you both declared

and initialized the entity at the same place, the coordinates are marked with a &. If the entity is set, the coordinates are marked with a @. If the entity is referenced, the coordinates are not marked.

Class is one of the following:

- Automatic
- BSS (uninitialized static internal)
- Common
- Common block
- Construct name
- Controlled (for an allocatable object)
- Controlled automatic (for an automatic object)
- Defined assignment
- Defined operator
- Derived type definition
- Entry
- External subprogram
- Function
- Generic name
- Internal subprogram
- Intrinsic
- Module
- Module function
- Module subroutine
- Namelist
- Pointee
- Private component
- Program
- Reference argument
- Renames
- Static
- **F2008** Submodule **F2008**
- Subroutine
- Use associated
- Value parameter

If you specify the **full** suboption with **-qxref** or **-qattr**, XL Fortran reports all entities in the compilation unit. If you do not specify this suboption, only the entities you actually use appear.

Object section

XL Fortran produces this section only when the **-qlist** compiler option is in effect. It contains the object code listing, which shows the source line number, the instruction offset in hexadecimal notation, the assembler mnemonic of the instruction, and the hexadecimal value of the instruction. On the right side, it also shows the cycle time of the instruction and the intermediate language of the compiler. Finally, the total number of machine instructions that are produced and the total cycle time (straight-line execution time) are displayed. There is a separate section for each compilation unit.

File table section

This section contains a table that shows the file number and file name for each main source file and include file used. It also lists the line number of the main source file at which the include file is referenced. This section is always present. The table also includes the file creation date and time.

Compilation unit epilogue Section

This is the last section of the listing for each compilation unit. It contains the diagnostics summary and indicates whether the unit was compiled successfully. This section is not present in the listing if the file contains only one compilation unit.

Compilation epilogue Section

The compilation epilogue section occurs only once at the end of the listing. At completion of the compilation, XL Fortran presents a summary of the compilation: number of source records that were read, compilation start time, compilation end time, total compilation time, total CPU time, virtual CPU time, and a summary of diagnosed conditions. This section is always present in a listing.

Chapter 12. XL Fortran technical information

This section contains details about XL Fortran that advanced programmers may need to diagnose unusual problems, run the compiler in a specialized environment, or do other things that a casual programmer is rarely concerned with.

External names in XL Fortran libraries

To minimize naming conflicts between user-defined names and the names that are defined in the runtime libraries, the names of routines in the runtime libraries are prefixed with an underscore (`_`), or `_xl`.

The XL Fortran runtime environment

Object code that the XL Fortran compiler produces often invokes compiler-supplied subprograms at run time to handle certain complex tasks. These subprograms are collected into several libraries.

The function of the XL Fortran Runtime Environment may be divided into these main categories:

- Support for Fortran I/O operations
- Mathematical calculation
- Operating-system services
- Support for SMP parallelization

Unless you bind statically, you cannot run object code produced by the XL Fortran compiler without the XL Fortran Runtime Environment.

The XL Fortran Runtime Environment is upward-compatible. Programs that are compiled and linked with a given level of the runtime environment and a given level of the operating system require the same or higher levels of both the runtime environment and the operating system to run.

External names in the runtime environment

Runtime subprograms are collected into libraries. By default, the compiler invocation command also invokes the linker and gives it the names of the libraries that contain runtime subprograms called by Fortran object code.

The names of these runtime subprograms are external symbols. When object code that is produced by the XL Fortran compiler calls a runtime subprogram, the `.o` object code file contains an external symbol reference to the name of the subprogram. A library contains an external symbol definition for the subprogram. The linker resolves the runtime subprogram call with the subprogram definition.

You should avoid using names in your XL Fortran program that conflict with names of runtime subprograms. Conflict can arise under two conditions:

- The name of a subroutine, function, or common block that is defined in a Fortran program has the same name as a library subprogram.
- The Fortran program calls a subroutine or function with the same name as a library subprogram but does not supply a definition for the called subroutine or function.

Technical details of the `-qfloat=hsflt` option

The `-qfloat=hsflt` option is unsafe for optimized programs that compute floating-point values that are outside the range of representation of single precision, not just outside the range of the result type. The range of representation includes both the precision and the exponent range.

Even when you follow the rules that are stated in the preceding paragraph and in “`-qfloat`” on page 134, programs that are sensitive to precision differences might not produce expected results. Because `-qfloat=hsflt` is not compliant with IEEE, programs will not always run as expected.

For example, in the following program, `X.EQ.Y` may be true or may be false:

```
REAL X, Y, A(2)
DOUBLE PRECISION Z
LOGICAL SAME

READ *, Z
X = Z
Y = Z
IF (X.EQ.Y) SAME = .TRUE.
! ...
! ... Calculations that do not change X or Y
! ...
CALL SUB(X)           ! X is stored in memory with truncated fraction.
IF (X.EQ.Y) THEN     ! Result might be different than before.
...

A(1) = Z
X = Z
A(2) = 1.             ! A(1) is stored in memory with truncated fraction.
IF (A(1).EQ.X) THEN ! Result might be different than expected.
...

```

If the value of `Z` has fractional bits that are outside the precision of a single-precision variable, these bits may be preserved in some cases and lost in others. This makes the exact results unpredictable when the double-precision value of `Z` is assigned to single-precision variables. For example, passing the variable as a dummy argument causes its value to be stored in memory with a fraction that is truncated rather than rounded.

Implementation details for `-qautodbl` promotion and padding

The following sections provide additional details about how the `-qautodbl` option works, to allow you to predict what happens during promotion and padding.

Terminology

The *storage relationship* between two data objects determines the relative starting addresses and the relative sizes of the objects. The `-qautodbl` option tries to preserve this relationship as much as possible.

Data objects can also have a *value relationship*, which determines how changes to one object affect another. For example, a program might store a value into one variable, and then read the value through a different storage-associated variable. With `-qautodbl` in effect, the representation of one or both variables might be different, so the value relationship is not always preserved.

An object that is affected by this option can be:

- *Promoted*, meaning that it is converted to a higher-precision data type. Usually, the resulting object is twice as large as it would be by default. Promotion applies to constants, variables, derived-type components, arrays, and functions (which include intrinsic functions) of the appropriate types.

Note: **BYTE**, **INTEGER**, **LOGICAL**, and **CHARACTER** objects are never promoted.

- *Padded*, meaning that the object keeps its original type but is followed by undefined storage space. Padding applies to **BYTE**, **INTEGER**, **LOGICAL**, and nonpromoted **REAL** and **COMPLEX** objects that may share storage space with promoted items. For safety, **POINTERS**, **TARGETS**, actual and dummy arguments, members of **COMMON** blocks, structures, pointer arrays, and pointer **COMPLEX** objects are always padded appropriately depending on the **-qautodbl** suboption. This is true whether or not they share storage with promoted objects.

Space added for padding ensures that the storage-sharing relationship that existed before conversion is maintained. For example, if array elements **I(20)** and **R(10)** start at the same address by default and if the elements of **R** are promoted and become twice as large, the elements of **I** are padded so that **I(20)** and **R(10)** still start at the same address.

Except for unformatted I/O statements, which read and write any padding that is present within structures, I/O statements do not process padding.

Note: The compiler does not pad **CHARACTER** objects.

Examples of storage relationships for **-qautodbl** suboptions

The examples in this section illustrate storage-sharing relationships between the following types of entities:

- **REAL(4)**
- **REAL(8)**
- **REAL(16)**
- **COMPLEX(4)**
- **COMPLEX(8)**
- **COMPLEX(16)**
- **INTEGER(8)**
- **INTEGER(4)**
- **CHARACTER(16)**.

Note: In the diagrams, solid lines represent the actual data, and dashed lines represent padding.

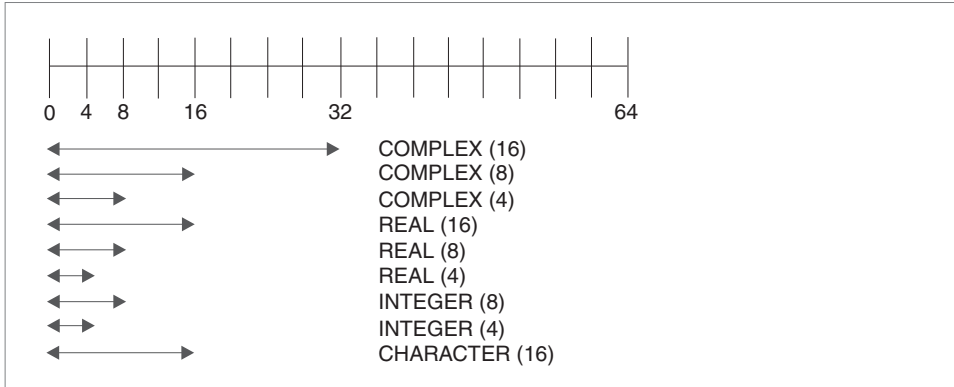

Figure 5. Storage relationships without the `-qautodbl` option

The figure above illustrates the default storage-sharing relationship of the compiler.

```
@process autodbl(none)
  block data
    complex(4) x8      /(1.123456789e0,2.123456789e0)/
    real(16) r16(2)   /1.123q0,2.123q0/
    integer(8) i8(2)  /1000,2000/
    character*5 c(2)  /"abcde","12345"/
    common /named/ x8,r16,i8,c
  end

  subroutine s()
    complex(4) x8
    real(16) r16(2)
    integer(8) i8(2)
    character*5 c(2)
    common /named/ x8,r16,i8,c
    !      x8      = (1.123456e0,2.123456e0)      ! promotion did not occur
    !      r16(1) = 1.123q0                        ! no padding
    !      r16(2) = 2.123q0                        ! no padding
    !      i8(1)  = 1000                           ! no padding
    !      i8(2)  = 2000                           ! no padding
    !      c(1)   = "abcde"                        ! no padding
    !      c(2)   = "12345"                        ! no padding
  end subroutine s
```

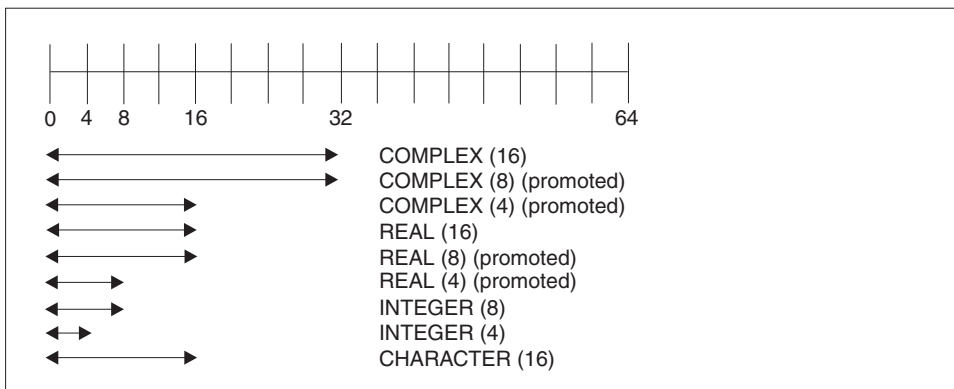

Figure 6. Storage relationships with `-qautodbl=dbl`

```
@process autodbl(dbl)
  block data
    complex(4) x8
```

```

real(16) r16(2)    /1.123q0,2.123q0/
real(8)  r8
real(4)  r4        /1.123456789e0/
integer(8) i8(2)  /1000,2000/
character*5 c(2)  /"abcde","12345"/
equivalence (x8,r8)
common /named/ r16,i8,c,r4
! Storage relationship between r8 and x8 is preserved.
! Data values are NOT preserved between r8 and x8.
end

subroutine s()
  real(16) r16(2)
  real(8)  r4
  integer(8) i8(2)
  character*5 c(2)
  common /named/ r16,i8,c,r4
! r16(1) = 1.123q0                                ! no padding
! r16(2) = 2.123q0                                ! no padding
! r4 = 1.123456789d0                               ! promotion occurred
! i8(1) = 1000                                     ! no padding
! i8(2) = 2000                                     ! no padding
! c(1) = "abcde"                                   ! no padding
! c(2) = "12345"                                   ! no padding
end subroutine s

```

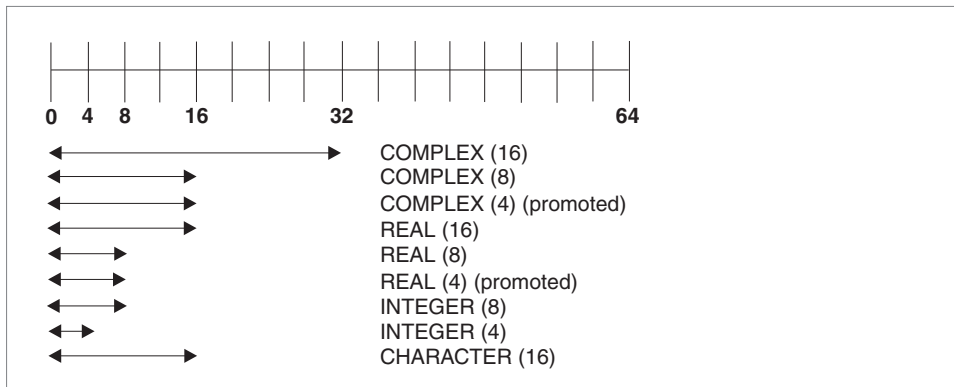

Figure 7. Storage relationships with `-qautobl=dbl4`

```

@process autodb1(db14)
  complex(8) x16    /(1.123456789d0,2.123456789d0)/
  complex(4) x8
  real(4)  r4(2)
  equivalence (x16,x8,r4)
! Storage relationship between r4 and x8 is preserved.
! Data values between r4 and x8 are preserved.
! x16 = (1.123456789d0,2.123456789d0)           ! promotion did not occur
! x8 = (1.123456789d0,2.123456789d0)           ! promotion occurred
! r4(1) = 1.123456789d0                         ! promotion occurred
! r4(2) = 2.123456789d0                         ! promotion occurred
end

```

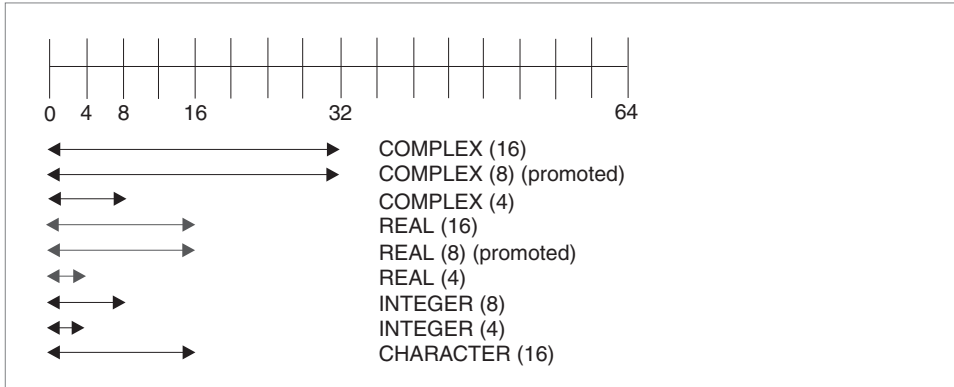

Figure 8. Storage relationships with `-qautodbl=dbl8`

```

@process autodbl(dbl8)
  complex(8) x16  /(1.123456789123456789d0,2.123456789123456789d0)/
  complex(4) x8
  real(8) r8(2)
  equivalence (x16,x8,r8)
! Storage relationship between r8 and x16 is preserved.
! Data values between r8 and x16 are preserved.
! x16 = (1.123456789123456789q0,2.123456789123456789q0)
!
! x8 = upper 8 bytes of r8(1) ! promotion occurred
! r8(1) = 1.123456789123456789q0 ! promotion did not occur
! r8(2) = 2.123456789123456789q0 ! promotion occurred
end

```

Chapter 13. XL Fortran internal limits

Language Feature	Limit
Maximum number of iterations performed by DO loops with loop control with index variable of type INTEGER(n) for $n = 1, 2$ or 4	$(2^{**}31)-1$
Maximum number of iterations performed by DO loops with loop control with index variable of type INTEGER(8)	$(2^{**}63)-1$
Maximum character format field width	$(2^{**}31)-1$
Maximum length of a format specification	$(2^{**}31)-1$
Maximum length of Hollerith and character constant edit descriptors	$(2^{**}31)-1$
Maximum length of a fixed source form statement	65,000
Maximum length of a free source form statement	65,000
Maximum number of continuation lines	n/a 1
Maximum number of nested INCLUDE lines	64
Maximum number of nested interface blocks	1024
Maximum number of statement numbers in a computed GOTO	999
Maximum number of times a format code can be repeated	$(2^{**}31)-1$
Allowable record numbers and record lengths for input/output files	The record number can be up to $(2^{**}63)-1$, and the record length can be up to $(2^{**}63)-1$ bytes. However, for unformatted sequential files, you must use the uwidth=64 runtime option for the record length to be greater than $(2^{**}31)-1$ and up to $(2^{**}63)-1$. If you use the default uwidth=32 runtime option, the maximum length of a record in an unformatted sequential file is $(2^{**}31)-1$ bytes.
Allowable bound range of an array dimension	The bound of an array dimension can be positive, negative, or zero within the range $-(2^{**}63)$ to $2^{**}63-1$.
Allowable external unit numbers	0 to $(2^{**}31)-1$ 2
Maximum numeric format field width	2000
Maximum number of concurrent open files	1024 3

1 You can have as many continuation lines as you need to create a statement with a maximum of 65,000 bytes.

2 The value must be representable in an **INTEGER(4)** object, even if specified by an **INTEGER(8)** variable.

3 In practice, this value is somewhat lower because of files that the runtime system may open, such as the preconnected units 0, 5, and 6.

Glossary

This glossary defines terms that are commonly used in this document. It includes definitions developed by the American National Standards Institute (ANSI) and entries from the *IBM Terminology* website.

A

abstract interface

An **ABSTRACT INTERFACE** consists of procedure characteristics and names of dummy arguments. Used to declare the interfaces for procedures and deferred bindings.

abstract type

A type that has the **ABSTRACT** attribute. A nonpolymorphic object cannot be declared to be of abstract type. A polymorphic object cannot be constructed or allocated to have a dynamic type that is abstract.

active processor

See *online processor*.

actual argument

An expression, variable, procedure, or alternate return specifier that is specified in a procedure reference.

alias A single piece of storage that can be accessed through more than a single name. Each name is an alias for that storage.

alphanumeric character

A letter or other symbol, excluding digits, used in a language. Usually the uppercase and lowercase letters A through Z plus other special symbols (such as \$ and _) allowed by a particular language.

alphanumeric

Pertaining to a character set that contains letters, digits, and usually other characters, such as punctuation marks and mathematical symbols.

American National Standard Code for Information Interchange

See *ASCII*.

argument

An expression that is passed to a function or subroutine. See also *actual argument*, *dummy argument*.

argument association

The relationship between an actual argument and a dummy argument during the invocation of a procedure.

arithmetic constant

A constant of type integer, real, or complex.

arithmetic expression

One or more arithmetic operators and arithmetic primaries, the evaluation of which produces a numeric value. An arithmetic expression can be an unsigned arithmetic constant, the name of an arithmetic constant, or a reference to an arithmetic variable, function reference, or a combination of such primaries formed by using arithmetic operators and parentheses.

arithmetic operator

A symbol that directs the performance of an arithmetic operation. The intrinsic arithmetic operators are:

+	addition
-	subtraction
*	multiplication
/	division
**	exponentiation

array An entity that contains an ordered group of scalar data. All objects in an array have the same data type and type parameters.

array declarator

The part of a statement that describes an array used in a program unit. It indicates the name of the array, the number of dimensions it contains, and the size of each dimension.

array element

A single data item in an array, identified by the array name and one or more subscripts. See also *subscript*.

array name

The name of an ordered set of data items.

array section

A subobject that is an array and is not a structure component.

ASCII The standard code, using a coded character set consisting of 7-bit coded characters (8-bits including parity check), that is used for information interchange among data processing systems, data communication systems, and associated equipment. The ASCII set consists of control characters and graphic characters. See also *Unicode*.

asynchronous

Pertaining to events that are not synchronized in time or do not occur in regular or predictable time intervals.

assignment statement

An executable statement that defines or redefines a variable based on the result of expression evaluation.

associate name

The name by which a selector of a **SELECT TYPE** or **ASSOCIATE** construct is known within the construct.

assumed-size array

A dummy array whose size is assumed from the associated actual argument. Its last upper bound is specified by an asterisk.

assumed-type object

An entity declared with **TYPE(*)**. An assumed-type object does not have a declared type, and its dynamic type and type parameters are assumed from its corresponding actual argument.

attribute

A property of a data object that may be specified in a type declaration statement, attribute specification statement, or through a default setting.

automatic parallelization

The process by which the compiler attempts to parallelize both explicitly coded **DO** loops and **DO** loops generated by the compiler for array language.

B**base object**

An object that is designated by the leftmost *part_name*.

base type

An extensible type that is not an extension of another type.

binary constant

A constant that is made of one or more binary digits (0 and 1).

bind

To relate an identifier to another object in a program; for example, to relate an identifier to a value, an address or another identifier, or to associate formal parameters and actual parameters.

binding label

A value of type default character that uniquely identifies how a variable, common block, subroutine, or function is known to a companion processor.

blank common

An unnamed common block.

block data subprogram

A subprogram headed by a **BLOCK DATA** statement and used to initialize variables in named common blocks.

bounds_remapping

Allows a user to view a flat, rank-1 array as a multi-dimensional array.

bss storage

Uninitialized static storage.

busy-wait

The state in which a thread keeps executing in a tight loop looking for more work once it has completed all of its work and there is no new work to do.

byte constant

A named constant that is of type byte.

byte type

A data type representing a one-byte storage area that can be used wherever a **LOGICAL(1)**, **CHARACTER(1)**, or **INTEGER(1)** can be used.

C**C descriptor**

A C structure of type `CFI_cdesc_t` that is defined in the `ISO_Fortran_binding.h` header file.

character constant

A string of one or more alphabetic characters enclosed in apostrophes or double quotation marks.

character expression

A character object, a character-valued function reference, or a sequence of them separated by the concatenation operator, with optional parentheses.

character operator

A symbol that represents an operation, such as concatenation (`//`), to be performed on character data.

character set

All the valid characters for a programming language or for a computer system.

character string

A sequence of consecutive characters.

character substring

A contiguous portion of a character string.

character type

A data type that consists of alphanumeric characters. See also *data type*.

chunk A subset of consecutive loop iterations.

class A set of types comprised of a base type and all types extended from it.

collating sequence

The sequence in which the characters are ordered for the purpose of sorting, merging, comparing, and processing indexed data sequentially.

comment

A language construct for the inclusion of text in a program that has no effect on the execution of the program.

common block

A storage area that may be referred to by a calling program and one or more subprograms.

compile

To translate a source program into an executable program (an object program).

compiler comment directive

A line in source code that is not a Fortran statement but is recognized and acted on by the compiler.

compiler directive

Source code that controls what XL Fortran does rather than what the user program does.

complex constant

An ordered pair of real or integer constants separated by a comma and enclosed in parentheses. The first constant of the pair is the real part of the complex number; the second is the imaginary part.

complex number

A number consisting of an ordered pair of real numbers, expressible in the form $a+bi$, where a and b are real numbers and i squared equals -1 .

complex type

A data type that represents the values of complex numbers. The value is expressed as an ordered pair of real data items separated by a comma and enclosed in parentheses. The first item represents the real part of the complex number; the second represents the imaginary part.

component

A constituent of a derived type.

component order

The ordering of the components of a derived type that is used for intrinsic formatted input/output and for structure constructors.

conform

To adhere to a prevailing standard. An executable program conforms to the Fortran 95 Standard if it uses only those forms and relationships described therein and if the executable program has an interpretation according to the Fortran 95 Standard. A program unit conforms to the Fortran 95 Standard if it can be included in an executable program in a manner that allows the executable program to be standard-conforming. A processor conforms to the standard if it executes standard-conforming programs in a manner that fulfills the interpretations prescribed in the standard.

connected unit

In XL Fortran, a unit that is connected to a file in one of three ways: explicitly via the **OPEN** statement to a named file, implicitly, or by preconnection.

constant

A data object with a value that does not change. The four classes of constants specify numbers (arithmetic), truth values (logical), character data (character), and typeless data (hexadecimal, octal, and binary). See also *variable*.

construct

A sequence of statements starting with a **SELECT CASE**, **DO**, **IF**, or **WHERE** statement, for example, and ending with the corresponding terminal statement.

contiguous

An array is contiguous if it has array elements in order that are not separated by other data objects. A data object with multiple parts is contiguous if the parts in order are not separated by other data objects.

continuation line

A line that continues a statement beyond its initial line.

control statement

A statement that is used to alter the continuous sequential invocation of statements; a control statement may be a conditional statement, such as **IF**, or an imperative statement, such as **STOP**.

D**data object**

A variable, constant, or subobject of a constant.

data striping

Spreading data across multiple storage devices so that I/O operations can be performed in parallel for better performance. Also known as *disk striping*.

data transfer statement

A **READ**, **WRITE**, or **PRINT** statement.

data type

The properties and internal representation that characterize data and functions. The intrinsic types are integer, real, complex, logical, and character. See also *intrinsic*.

debug line

Allowed only for fixed source form, a line containing source code that is to be used for debugging. Debug lines are defined by a D or X in column 1. The handling of debug lines is controlled by the **-qdlines** and **-qxlines** compiler options.

decimal symbol

The symbol that separates the whole and fractional parts of a real number.

declared type

The type that a data entity is declared to have. May differ from the type during execution (the dynamic type) for polymorphic data entities.

default initialization

The initialization of an object with a value specified as part of a derived type definition.

deferred binding

A binding with the **DEFERRED** attribute. A deferred binding can only appear in an abstract type definition.

definable variable

A variable whose value can be changed by the appearance of its name or designator on the left of an assignment statement.

delimiters

A pair of parentheses or slashes (or both) used to enclose syntactic lists.

denormalized number

An IEEE number with a very small absolute value and lowered precision. A denormalized number is represented by a zero exponent and a non-zero fraction.

derived type

A type whose data have components, each of which is either of intrinsic type or of another derived type.

digit A character that represents a nonnegative integer. For example, any of the numerals from 0 through 9.

directive

A type of comment that provides instructions and information to the compiler.

disk striping

See *data striping*.

DO loop

A range of statements invoked repetitively by a **DO** statement.

DO variable

A variable, specified in a **DO** statement, that is initialized or incremented prior to each occurrence of the statement or statements within a **DO** loop. It is used to control the number of times the statements within the range are executed.

DOUBLE PRECISION constant

A constant of type real with twice the precision of the default real precision.

dummy argument

An entity whose name appears in the parenthesized list following the procedure name in a **FUNCTION**, **SUBROUTINE**, **ENTRY**, or statement function statement.

dynamic dimensioning

The process of re-evaluating the bounds of an array each time the array is referenced.

dynamic extent

For a directive, the lexical extent of the directive and all subprograms called from within the lexical extent.

dynamic type

The type of a data entity during execution of a program. The dynamic type of a data entity that is not polymorphic is the same as its declared type.

E**edit descriptor**

An abbreviated keyword that controls the formatting of integer, real, or complex data.

effective item

A scalar object resulting from expanding an input/output list.

elemental

Pertaining to an intrinsic operation, procedure or assignment that is applied independently to elements of an array or corresponding elements of a set of conformable arrays and scalars.

embedded blank

A blank that is surrounded by any other characters.

entity A general term for any of the following: a program unit, procedure, operator, interface block, common block, external unit, statement function, type, named variable, expression, component of a structure, named constant, statement label, construct, or namelist group.

environment variable

A variable that describes the operating environment of the process.

epoch The starting date used for time in POSIX. It is Jan 01 00:00:00 GMT 1970.

executable program

A program that can be executed as a self-contained procedure. It consists of a main program and, optionally, modules, submodules, subprograms and non-Fortran external procedures.

executable statement

A statement that causes an action to be taken by the program; for example, to perform a calculation, test conditions, or alter normal sequential execution.

explicit initialization

The initialization of an object with a value in a data statement initial value list, block data program unit, type declaration statement, or array constructor.

explicit interface

For a procedure referenced in a scoping unit, the property of being an internal procedure, module procedure, intrinsic procedure, external

procedure that has an interface block, recursive procedure reference in its own scoping unit, or dummy procedure that has an interface block.

expression

A sequence of operands, operators, and parentheses. It may be a variable, a constant, or a function reference, or it may represent a computation.

extended-precision constant

A processor approximation to the value of a real number that occupies 16 consecutive bytes of storage.

extended type

An extensible type that is an extension of another type. A type that is declared with the **EXTENDS** attribute.

extensible type

A type from which new types may be derived using the **EXTENDS** attribute. A nonsequence type that does not have the **BIND** attribute.

extension type

A base type is an extension type of itself only. An extended type is an extension type of itself and of all types for which its parent type is an extension.

external file

A sequence of records on an input/output device. See also *internal file*.

external name

The name of a common block, subroutine, or other global procedure, which the linker uses to resolve references from one compilation unit to another.

external procedure

A procedure that is defined by an external subprogram or by a means other than Fortran.

F

field An area in a record used to contain a particular category of data.

file A sequence of records. See also *external file*, *internal file*.

file index

See *i-node*.

final subroutine

A subroutine that is called automatically during finalization.

finalizable

A type that has final subroutines, or that has a finalizable component. An object of finalizable type.

finalization

The process of calling user-defined final subroutines immediately before destroying an object.

floating-point number

A real number represented by a pair of distinct numerals. The real number is the product of the fractional part, one of the numerals, and a value obtained by raising the implicit floating-point base to a power indicated by the second numeral.

format

A defined arrangement of such things as characters, fields, and lines, usually used for displays, printouts, or files.

To arrange such things as characters, fields, and lines.

formatted data

Data that is transferred between main storage and an input/output device according to a specified format. See also *list-directed* and *unformatted record*.

function

A procedure that returns the value of a single variable or an object and usually has a single exit. See also *intrinsic procedure*, *subprogram*.

G**generic identifier**

A lexical token that appears in an **INTERFACE** statement and is associated with all the procedures in an interface block.

H**hard limit**

A system resource limit that can only be raised or lowered by using root authority, or cannot be altered because it is inherent in the system or operating environments's implementation. See also *soft limit*.

hexadecimal

Pertaining to a system of numbers to the base sixteen; hexadecimal digits range from 0 (zero) through 9 (nine) and A (ten) through F (fifteen).

hexadecimal constant

A constant, usually starting with special characters, that contains only hexadecimal digits.

high order transformations

A type of optimization that restructures loops and array language.

Hollerith constant

A string of any characters capable of representation by XL Fortran and preceded with *nH*, where *n* is the number of characters in the string.

host

A main program or subprogram that contains an internal procedure is called the host of the internal procedure. A module or submodule that contains a module procedure is called the host of the module procedure. A module or submodule is called the host of its descendant submodules.

host association

The process by which an internal subprogram, module subprogram, derived-type definition, or submodule accesses the entities of its host.

host instance

An instance of the host procedure that supplies the host environment of the internal procedure.

I**IPA**

Interprocedural analysis, a type of optimization that allows optimizations to be performed across procedure boundaries and across calls to procedures in separate source files.

implicit interface

A procedure referenced in a scoping unit other than its own is said to have an implicit interface if the procedure is an external procedure that does not

have an interface block, a dummy procedure that does not have an interface block, or a statement function.

implied DO

An indexing specification (similar to a **DO** statement, but without specifying the word **DO**) with a list of data elements, rather than a set of statements, as its range.

infinity

An IEEE number (positive or negative) created by overflow or division by zero. Infinity is represented by an exponent where all the bits are 1's, and a zero fraction.

inherit

To acquire from a parent. Type parameters, components, or procedure bindings of an extended type that are automatically acquired from its parent type without explicit declaration in the extended type are said to be inherited.

inheritance association

The relationship between the inherited components and the parent component in an extended type.

i-node The internal structure that describes the individual files in the operating system. There is at least one i-node for each file. An i-node contains the node, type, owner, and location of a file. A table of i-nodes is stored near the beginning of a file system. Also known as *file index*.

input/output (I/O)

Pertaining to either input or output, or both.

input/output list

A list of variables in an input or output statement specifying the data to be read or written. An output list can also contain a constant, an expression involving operators or function references, or an expression enclosed in parentheses.

integer constant

An optionally signed digit string that contains no decimal point.

interface block

A sequence of statements from an **INTERFACE** statement to its corresponding **END INTERFACE** statement.

interface body

A sequence of statements in an interface block from a **FUNCTION** or **SUBROUTINE** statement to its corresponding **END** statement.

interference

A situation in which two iterations within a **DO** loop have dependencies upon one another.

internal file

A sequence of records in internal storage. See also *external file*.

interprocedural analysis

See *IPA*.

intrinsic

Pertaining to types, operations, assignment statements, and procedures that are defined by Fortran language standards and can be used in any scoping unit without further definition or specification.

intrinsic module

A module that is provided by the compiler and is available to any program.

intrinsic procedure

A procedure that is provided by the compiler and is available to any program.

K**keyword**

A statement keyword is a word that is part of the syntax of a statement (or directive) and may be used to identify the statement.

An argument keyword specifies the name of a dummy argument

kind type parameter

A parameter whose values label the available kinds of an intrinsic type or a derived-type parameter that is declared to have the **KIND** attribute.

L**lexical extent**

All of the code that appears directly within a directive construct.

lexical token

A sequence of characters with an indivisible interpretation.

link-edit

To create a loadable computer program by means of a linker.

linker A program that resolves cross-references between separately compiled or assembled object modules and then assigns final addresses to create a single relocatable load module. If a single object module is linked, the linker simply makes it relocatable.

list-directed

A predefined input/output format that depends on the type, type parameters, and values of the entities in the data list.

literal A symbol or a quantity in a source program that is itself data, rather than a reference to data.

literal constant

A lexical token that directly represents a scalar value of intrinsic type.

load balancing

An optimization strategy that aims at evenly distributing the work load among processors.

logical constant

A constant with a value of either true or false (or T or F).

logical operator

A symbol that represents an operation on logical expressions:

.NOT.	(logical negation)
.AND.	(logical conjunction)
.OR.	(logical union)
.EQV.	(logical equivalence)
.NEQV.	(logical nonequivalence)
.XOR.	(logical exclusive disjunction)

loop A statement block that executes repeatedly.

M

_main The default name given to a main program by the compiler if the main program was not named by the programmer.

main program

The first program unit to receive control when a program is run. See also *subprogram*.

master thread

The head process of a team of threads.

module

A program unit that contains or accesses definitions to be accessed by other program units.

module procedure interface body

An interface body whose initial statement contains the **MODULE** prefix specifier. A module procedure interface body specifies the interface of a separate module procedure.

module subprogram

A subprogram that is contained in a module or submodule, but is not an internal subprogram. A module subprogram is a function subprogram, a subroutine subprogram, or a separate module subprogram.

mutex A primitive object that provides mutual exclusion between threads. A mutex is used cooperatively between threads to ensure that only one of the cooperating threads is allowed to access shared data or run certain application code at a time.

N

NaN (not-a-number)

A symbolic entity encoded in floating-point format that does not correspond to a number. See also *quiet NaN*, *signaling NaN*.

name A lexical token consisting of a letter followed by up to 249 alphanumeric characters (letters, digits, and underscores). Note that in FORTRAN 77, this was called a symbolic name.

named common

A separate, named common block consisting of variables.

namelist group name

The first parameter in the NAMELIST statement that names a list of names to be used in READ, WRITE, and PRINT statements.

negative zero

An IEEE representation where the exponent and fraction are both zero, but the sign bit is 1. Negative zero is treated as equal to positive zero.

nest To incorporate a structure or structures of some kind into a structure of the same kind. For example, to nest one loop (the nested loop) within another loop (the nesting loop); to nest one subroutine (the nested subroutine) within another subroutine (the nesting subroutine).

NEWUNIT value

A negative number that is less than -2 and is unequal to the unit number of any currently connected file. It is a unit value that the runtime library assigns to the variable specified by the **NEWUNIT=** specifier.

nonexecutable statement

A statement that describes the characteristics of a program unit, data, editing information, or statement functions, but does not cause any action to be taken by the program.

nonexisting file

A file that does not physically exist on any accessible storage medium.

normal

A floating-point number that is not denormal, infinity, or NaN.

not-a-number

See *NaN*.

numeric constant

A constant that expresses an integer, real, complex, or byte number.

numeric storage unit

The space occupied by a nonpointer scalar object of type default integer, default real, or default logical.

O

octal Pertaining to a system of numbers to the base eight; the octal digits range from 0 (zero) through 7 (seven).

octal constant

A constant that is made of octal digits.

one-trip DO-loop

A **DO** loop that is executed at least once, if reached, even if the iteration count is equal to 0. (This type of loop is from FORTRAN 66.)

online processor

In a multiprocessor machine, a processor that has been activated (brought online). The number of online processors is less than or equal to the number of physical processors actually installed in the machine. Also known as *active processor*.

operator

A specification of a particular computation involving one or two operands.

P

pad To fill unused positions in a field or character string with dummy data, usually zeros or blanks.

paging space

Disk storage for information that is resident in virtual memory but is not currently being accessed.

parent component

The component of an entity of extended type that corresponds to its inherited portion.

parent type

The extensible type from which an extended type is derived.

passed-object dummy argument

The dummy argument of a type-bound procedure or procedure pointer component that becomes associated with the object through which the procedure was invoked.

PDF See *profile-directed feedback*.

pointee array

An explicit-shape or assumed-size array that is declared in an integer **POINTER** statement or other specification statement.

pointer

A variable that has the **POINTER** attribute. A pointer must not be referenced or defined unless it is pointer associated with a target. If it is an array, it does not have a shape unless it is pointer-associated.

polymorphic

Able to be of differing types during program execution. An object declared with the **CLASS** keyword is polymorphic.

preconnected file

A file that is connected to a unit at the beginning of execution of the executable program. Standard error, standard input, and standard output are preconnected files (units 0, 5 and 6, respectively).

predefined convention

The implied type and length specification of a data object, based on the initial character of its name when no explicit specification is given. The initial characters I through N imply type integer of length 4; the initial characters A through H, O through Z, \$, and _ imply type real of length 4.

present

A dummy argument is present in an instance of a subprogram if it is associated with an actual argument and the actual argument is a dummy argument that is present in the invoking procedure or is not a dummy argument of the invoking procedure.

primary

The simplest form of an expression: an object, array constructor, structure constructor, function reference, or expression enclosed in parentheses.

procedure

A computation that may be invoked during program execution. It may be a function or a subroutine. It may be an intrinsic procedure, an external procedure, a module procedure, an internal procedure, a dummy procedure, or a statement function. A subprogram may define more than one procedure if it contains **ENTRY** statements.

procedure binding

See type-bound procedure.

procedure pointer

A procedure entity that has the **EXTERNAL** and **POINTER** attributes. It can be pointer associated with an external procedure, a module procedure, a dummy procedure or another procedure pointer.

profile-directed feedback (PDF)

A type of optimization that uses information collected during application execution to improve performance of conditional branches and in frequently executed sections of code.

program state

The values of user variables at certain points during the execution of a program.

program unit

A main program or subprogram.

pure

An attribute of a procedure that indicates there are no side effects.

Q

quiet NaN

A NaN (not-a-number) value that does not signal an exception. The intent of a quiet NaN is to propagate a NaN result through subsequent computations. See also *NaN*, *signaling NaN*.

R

random access

An access method in which records can be read from, written to, or removed from a file in any order. See also *sequential access*.

rank The number of dimensions of an array.

real constant

A string of decimal digits that expresses a real number. A real constant must contain a decimal point, a decimal exponent, or both.

record A sequence of values that is treated as a whole within a file.

relational expression

An expression that consists of an arithmetic or character expression, followed by a relational operator, followed by another arithmetic or character expression.

relational operator

The words or symbols used to express a relational condition or a relational expression:

.GT.	greater than
.GE.	greater than or equal to
.LT.	less than
.LE.	less than or equal to
.EQ.	equal to
.NE.	not equal to

result variable

The variable that returns the value of a function.

return specifier

An argument specified for a statement, such as *CALL*, that indicates to which statement label control should return, depending on the action specified by the subroutine in the *RETURN* statement.

S

scalar A single datum that is not an array.

Not having the property of being an array.

scale factor

A number indicating the location of the decimal point in a real number (and, on input, if there is no exponent, the magnitude of the number).

scope That part of an executable program within which a lexical token has a single interpretation.

scope attribute

That part of an executable program within which a lexical token has a single interpretation of a particular named property or entity.

scoping unit

A derived-type definition.

A **BLOCK** construct (not including any nested **BLOCK** constructs, derived-type definitions, and interface bodies within it).

An interface body.

A program unit or subprogram, excluding derived-type definitions, **BLOCK** constructs, interface bodies, and subprograms contained within it.

selector

The object that is associated with the associate name in an **ASSOCIATE** construct.

semantics

The relationships of characters or groups of characters to their meanings, independent of the manner of their interpretation and use. See also *syntax*.

separate module procedure

A module procedure that is defined by a separate module subprogram or by a function or subroutine subprogram whose initial statement contains the **MODULE** prefix specifier. A separate module procedure defines a module procedure interface body.

separate module subprogram

A module subprogram whose initial statement contains the **MODULE PROCEDURE** statement. A separate module subprogram defines a module procedure interface body.

sequential access

An access method in which records are read from, written to, or removed from a file based on the logical order of the records in the file. See also *random access*.

signaling NaN

A NaN (not-a-number) value that signals an invalid operation exception whenever it appears as an operand. The intent of the signaling NaN is to catch program errors, such as using an uninitialized variable. See also *NaN*, *quiet NaN*.

sleep The state in which a thread completely suspends execution until another thread signals it that there is work to do.

SMP See *symmetric multiprocessing*.

soft limit

A system resource limit that is currently in effect for a process. The value of a soft limit can be raised or lowered by a process, without requiring root authority. The soft limit for a resource cannot be raised above the setting of the hard limit. See also *hard limit*.

spill space

The stack space reserved in each subprogram in case there are too many variables to hold in registers and the program needs temporary storage for register contents.

specification statement

A statement that provides information about the data used in the source program. The statement could also supply information to allocate data storage.

stanza A group of lines in a file that together have a common function or define a part of the system. Stanzas are usually separated by blank lines or colons, and each stanza has a name.

statement

A language construct that represents a step in a sequence of actions or a set of declarations. Statements fall into two broad classes: executable and nonexecutable.

statement function

A name, followed by a list of dummy arguments, that is equated with an intrinsic or derived-type expression, and that can be used as a substitute for the expression throughout the program.

statement label

A number made up of one to five digits that is used to identify a statement. Statement labels can be used to transfer control, to define the range of a **DO**, or to refer to a **FORMAT** statement.

storage association

The relationship between two storage sequences if a storage unit of one is the same as a storage unit of the other.

structure

A scalar data object of derived type.

structure component

The part of a data object of derived-type corresponding to a component of its type.

submodule

A program unit that extends a module or another submodule. A submodule accesses the definitions from its ancestor module or submodules through host association. It might contain definitions to be accessed by its descendant submodules through host association. It might also contain separate module procedures that define module procedure interface bodies declared in its ancestor module or submodules.

subobject

A portion of a named data object that may be referenced or defined independently of other portions. It can be an array element, array section, structure component, or substring.

subprogram

A function subprogram or a subroutine subprogram. Note that in FORTRAN 77, a block data program unit was called a subprogram. See also *main program*.

subroutine

A procedure that is invoked by a **CALL** statement or defined assignment statement.

subscript

A subscript quantity or set of subscript quantities enclosed in parentheses and used with an array name to identify a particular array element.

substring

A contiguous portion of a scalar character string. (Although an array section can specify a substring selector, the result is not a substring.)

symmetric multiprocessing (SMP)

A system in which functionally-identical multiple processors are used in parallel, providing simple and efficient load-balancing.

synchronous

Pertaining to an operation that occurs regularly or predictably with regard to the occurrence of a specified event in another process.

syntax The rules for the construction of a statement. See also *semantics*.

T

target A named data object specified to have the **TARGET** attribute, a data object created by an **ALLOCATE** statement for a pointer, or a subobject of such an object.

thread A stream of computer instructions that is in control of a process. A multithread process begins with one stream of instructions (one thread) and may later create other instruction streams to perform tasks.

thread-visible variable

A variable that can be accessed by more than one thread.

time slice

An interval of time on the processing unit allocated for use in performing a task. After the interval has expired, processing unit time is allocated to another task, so a task cannot monopolize processing unit time beyond a fixed limit.

token In a programming language, a character string, in a particular format, that has some defined significance.

trigger constant

A sequence of characters that identifies comment lines as compiler comment directives.

Type-bound procedure

A procedure binding in a type definition. The procedure may be referenced by the binding-name via any object of that dynamic type, as a defined operator, by defined assignment, or as part of the finalization process.

type compatible

All entities are type compatible with other entities of the same type. Unlimited polymorphic entities are type compatible with all entities; other polymorphic entities are type compatible with entities whose dynamic type is an extension type of the polymorphic entity's declared type.

type declaration statement

A statement that specifies the type, length, and attributes of an object or function. Objects can be assigned initial values.

type parameter

A parameter of a data type. **KIND** and **LEN** are the type parameters of intrinsic types. A type parameter of a derived type has either a **KIND** or a **LEN** attribute.

Note: The type parameters of a derived type are defined in the derived-type definition.

U**unformatted record**

A record that is transmitted unchanged between internal and external storage.

Unicode

A universal character encoding standard that supports the interchange,

processing, and display of text that is written in any of the languages of the modern world. It also supports many classical and historical texts in a number of languages. The Unicode standard has a 16-bit international character set defined by ISO 10646. See also *ASCII*.

unit A means of referring to a file to use in input/output statements. A unit can be connected or not connected to a file. If connected, it refers to a file. The connection is symmetric: that is, if a unit is connected to a file, the file is connected to the unit.

unsafe option

Any option that could result in undesirable results if used in the incorrect context. Other options may result in very small variations from the default result, which is usually acceptable. Typically, using an unsafe option is an assertion that your code is not subject to the conditions that make the option unsafe.

use association

The association of names in different scoping units specified by a **USE** statement.

V

variable

A data object whose value can be defined and redefined during the execution of an executable program. It may be a named data object, array element, array section, structure component, or substring. Note that in FORTRAN 77, a variable was always scalar and named.

X

XPG4 X/Open Common Applications Environment (CAE) Portability Guide Issue 4; a document which defines the interfaces of the X/Open Common Applications Environment that is a superset of POSIX.1-1990, POSIX.2-1992, and POSIX.2a-1992 containing extensions to POSIX standards from XPG3.

Z

zero-length character

A character object that has a length of 0 and is always defined.

zero-sized array

An array that has a lower bound that is greater than its corresponding upper bound. The array is always defined.

Notices

Programming interfaces: Intended programming interfaces allow the customer to write programs to obtain the services of IBM XL Fortran for Linux.

This information was developed for products and services offered in the U.S.A. IBM may not offer the products, services, or features discussed in this document in other countries. Consult your local IBM representative for information on the products and services currently available in your area. Any reference to an IBM product, program, or service is not intended to state or imply that only that IBM product, program, or service may be used. Any functionally equivalent product, program, or service that does not infringe any IBM intellectual property right may be used instead. However, it is the user's responsibility to evaluate and verify the operation of any non-IBM product, program, or service.

IBM may have patents or pending patent applications covering subject matter described in this document. The furnishing of this document does not give you any license to these patents. You can send license inquiries, in writing, to:

IBM Director of Licensing
IBM Corporation
North Castle Drive, MD-NC119
Armonk, NY 10504-1785
U.S.A.

For license inquiries regarding double-byte (DBCS) information, contact the IBM Intellectual Property Department in your country or send inquiries, in writing, to:

Intellectual Property Licensing
Legal and Intellectual Property Law
IBM Japan, Ltd.
19-21, Nihonbashi-Hakozakicho, Chuo-ku
Tokyo 103-8510, Japan

The following paragraph does not apply to the United Kingdom or any other country where such provisions are inconsistent with local law:

INTERNATIONAL BUSINESS MACHINES CORPORATION PROVIDES THIS PUBLICATION "AS IS" WITHOUT WARRANTY OF ANY KIND, EITHER EXPRESS OR IMPLIED, INCLUDING, BUT NOT LIMITED TO, THE IMPLIED WARRANTIES OF NON-INFRINGEMENT, MERCHANTABILITY OR FITNESS FOR A PARTICULAR PURPOSE. Some states do not allow disclaimer of express or implied warranties in certain transactions, therefore, this statement may not apply to you.

This information could include technical inaccuracies or typographical errors. Changes are periodically made to the information herein; these changes will be incorporated in new editions of the publication. IBM may make improvements and/or changes in the product(s) and/or the program(s) described in this publication at any time without notice.

Any references in this information to non-IBM websites are provided for convenience only and do not in any manner serve as an endorsement of those

websites. The materials at those websites are not part of the materials for this IBM product and use of those websites is at your own risk.

IBM may use or distribute any of the information you supply in any way it believes appropriate without incurring any obligation to you.

Licenses of this program who want to have information about it for the purpose of enabling: (i) the exchange of information between independently created programs and other programs (including this one) and (ii) the mutual use of the information which has been exchanged, should contact:

Intellectual Property Dept. for Rational Software
IBM Corporation
5 Technology Park Drive
Westford, MA 01886
U.S.A.

Such information may be available, subject to appropriate terms and conditions, including in some cases, payment of a fee.

The licensed program described in this document and all licensed material available for it are provided by IBM under terms of the IBM Customer Agreement, IBM International Program License Agreement or any equivalent agreement between us.

Any performance data contained herein was determined in a controlled environment. Therefore, the results obtained in other operating environments may vary significantly. Some measurements may have been made on development-level systems and there is no guarantee that these measurements will be the same on generally available systems. Furthermore, some measurements may have been estimated through extrapolation. Actual results may vary. Users of this document should verify the applicable data for their specific environment.

Information concerning non-IBM products was obtained from the suppliers of those products, their published announcements or other publicly available sources. IBM has not tested those products and cannot confirm the accuracy of performance, compatibility or any other claims related to non-IBM products. Questions on the capabilities of non-IBM products should be addressed to the suppliers of those products.

All statements regarding IBM's future direction or intent are subject to change or withdrawal without notice, and represent goals and objectives only.

This information contains examples of data and reports used in daily business operations. To illustrate them as completely as possible, the examples include the names of individuals, companies, brands, and products. All of these names are fictitious and any similarity to the names and addresses used by an actual business enterprise is entirely coincidental.

COPYRIGHT LICENSE:

This information contains sample application programs in source language, which illustrates programming techniques on various operating platforms. You may copy, modify, and distribute these sample programs in any form without payment to IBM, for the purposes of developing, using, marketing or distributing application programs conforming to the application programming interface for the operating

platform for which the sample programs are written. These examples have not been thoroughly tested under all conditions. IBM, therefore, cannot guarantee or imply reliability, serviceability, or function of these programs. The sample programs are provided "AS IS", without warranty of any kind. IBM shall not be liable for any damages arising out of your use of the sample programs.

Each copy or any portion of these sample programs or any derivative work, must include a copyright notice as follows:

© (your company name) (year). Portions of this code are derived from IBM Corp. Sample Programs. © Copyright IBM Corp. 1998, 2016.

This software and documentation are based in part on the Fourth Berkeley Software Distribution under license from the Regents of the University of California. We acknowledge the following institution for its role in this product's development: the Electrical Engineering and Computer Sciences Department at the Berkeley campus.

PRIVACY POLICY CONSIDERATIONS:

IBM Software products, including software as a service solutions, ("Software Offerings") may use cookies or other technologies to collect product usage information, to help improve the end user experience, or to tailor interactions with the end user, or for other purposes. In many cases no personally identifiable information is collected by the Software Offerings. Some of our Software Offerings can help enable you to collect personally identifiable information. If this Software Offering uses cookies to collect personally identifiable information, specific information about this offering's use of cookies is set forth below.

This Software Offering does not use cookies or other technologies to collect personally identifiable information.

If the configurations deployed for this Software Offering provide you as customer the ability to collect personally identifiable information from end users via cookies and other technologies, you should seek your own legal advice about any laws applicable to such data collection, including any requirements for notice and consent.

For more information about the use of various technologies, including cookies, for these purposes, see IBM's Privacy Policy at <http://www.ibm.com/privacy> and IBM's Online Privacy Statement at <http://www.ibm.com/privacy/details> in the section entitled "Cookies, Web Beacons and Other Technologies," and the "IBM Software Products and Software-as-a-Service Privacy Statement" at <http://www.ibm.com/software/info/product-privacy>.

Trademarks

IBM, the IBM logo, and [ibm.com](http://www.ibm.com) are trademarks or registered trademarks of International Business Machines Corp., registered in many jurisdictions worldwide. Other product and service names might be trademarks of IBM or other companies. A current list of IBM trademarks is available on the web at "Copyright and trademark information" at <http://www.ibm.com/legal/copytrade.shtml>.

Adobe and the Adobe logo are either registered trademarks or trademarks of Adobe Systems Incorporated in the United States, other countries, or both.

Linux is a registered trademark of Linus Torvalds in the United States, other countries, or both.

NVIDIA and CUDA are either registered trademarks or trademarks of NVIDIA Corporation in the United States, other countries, or both.

UNIX is a registered trademark of The Open Group in the United States and other countries.

Windows is a trademark of Microsoft Corporation in the United States, other countries, or both.

Index

Numerics

64-bit environment
overview 293

A

API support
POSIX pthreads levels 25

B

bozlitargs suboptions
qxlf2003 271

C

C preprocessors
cpp commands 32
code generation
systems 32
command-line options
passing 31
compatibility
options 66
compilation
cancelling 25
CUDA Fortran programs 23
libraries 24
overview 20
problem fixing 303
SMP programs 25
specific architectures 32
static libraries 24
compilation orders
effect 25
modules 25
compiler commands
cleanpdf 287
genhtml 288
mergepdf 288
showpdf 289
compiler listings
diagnostics 307
compiler option
precedence 29
compiler options
scope 29
specifying
command lines 29
source files 30
summary 51
compilers
customization 67
overview 1
compiling
Fortran 2003Fortran 2003
programs 23
Fortran 2008Fortran 2008
programs 23

compiling programs
Fortran 90 22
Fortran 95 22
configurable compilers
overview 4
configuration
custom configuration files 10
configuration file attributes
overview 14
configuration files
code attributes 14
customizing 14
editing 14
ipa attributes 15
location specifying 48
options attributes 16
control listings
options 60
controlling
floating point 56
input 53
integer 56
language element 54
object code 57
output 51
conversion errors
overview 40

D

data objects
storage relationship 316
debugging
Fortran programs 306
options 58
overview 299
defaults
customizing 14
libraries 8
search paths 8
diagnostic listings
overview 6
diagnostic messagesXL Fortran messages
formats 300
different systems
compiling 36
executing 36
directives
cpp 33
displaying
binary files
compiler versions 31
parent modules 31
dynamic
linking 35

E

editing
source files 19

edits
configuration files 14
environment problems
fixing 301
environment variables
Basic Linear Algebra Subprograms
(BLAS) library 48
compile time 7
custom configuration files 48
implicitly connected files 9
profile-directed feedback 8
runtime option setting 37
specifying name
scratch files 9
temporary file directory
TMPDIR 9
XLFRTOPTS 44, 46
error checking
options 58
error messages
fixing 304
formats 300
overview 308
error severity
overview 299
severe errors 299
unrecoverable errors 299
warnings 299
errors
severity 299
exception handling
runtime 48
execution
canceling 36
external names
runtime environments 315

F

files
suffixes 15
fixing
compile-time problems 303
installation problems 301
link-time problems 304
runtime problems 306
system environment problems 301
floating-point
conversion options 316
exception handling 48
floating-point control
overview 56
Fortran 2003
compiling 23
Fortran 2008
compiling 23
Fortran 90
compiling 22
Fortran 95
compiling 22

- Fortran compiler listings
 - attributes 311
 - compilation epilogue 313
 - compilation unit epilogue 313
 - cross reference 311
 - data reorganization report 311
 - file tables 313
 - headers 307
 - objects 312
 - options 307
 - PDF reports 308
 - source 308
 - transformation reports 309
- Fortran program development
 - overview 19

G

- generating code
 - different systems 32

H

- hardware
 - support 3

I

- implicitly connected file
 - name
 - specifying 9
- implicitly connected files
 - names 9
- informational messages
 - errors 299
- input control
 - overview 53
- input files
 - overview 26
- installation
 - instructions 7
- installation problems
 - fixing 301
- integer control
 - overview 56
- internal compiler errors
 - fixing 301
- internal limits
 - overview 321

L

- language element control
 - overview 54
- language extensions
 - support 3
- language standards
 - support 3
- language support
 - overview 3
- language-level errors
 - overview 299
- level of { IDEP206A: File not found. }XL
 - Fortran, determining
 - determining 17

- libraries
 - compiling 24
 - default search paths 8
 - dynamic linking 24
 - external names 315
 - linking 24
 - search paths setting 8
 - static linking 24
- libxf90.so library
 - overview 37
- linking
 - application 24
 - dynamic 35
 - ld command 35
 - libraries 24
 - naming conflicts 36
 - overview 65
 - programs 34
 - separate steps 35
 - shared libraries 25
 - static 35

M

- messages 304
 - format of diagnostic messages 300
- installation problems 301
- limiting numbers 301
- options 60
- runtime problems fixing 306

O

- object code control
 - overview 57
- operating systems
 - support 3
- optimization
 - overview 62
 - programs 6
- option
 - settings 29
- options
 - source files 30
- output control
 - overview 51
- output files
 - overview 27

P

- padding
 - additional details 316
- performance optimization
 - overview 62
- POSIX pthreads
 - API support 25
- preprocessing
 - problems 34
- preprocessor
 - options 34
 - passing 34
 - files 33
- problem determination
 - overview 299

- problems
 - compile time 304
- profile-directed feedback
 - environment variables 8
- profiling data files
 - overview 27
- program optimization
 - overview 6
- programs
 - compiling 20
- promotion
 - additional details 316
- promotion of data types
 - overview 316

Q

- qautodbl suboptions
 - storage relationships 317

R

- reports
 - PDF 308
 - transformation 309
- return code
 - compilers 300
- running
 - programs 36
- runtime
 - exceptions 48
 - options setting 37
 - problem fixing 306
- runtime behavior
 - options 47
- runtime environment
 - external names 315
- runtime exception
 - overview 48
- runtime libraries
 - POSIX pthreads support 37
- runtime options
 - OMP and SMP setting 48

S

- scratch files
 - names 9
- setting
 - runtime options 37
- shell
 - bash 7
 - csh 7
 - ksh 7
 - sh 7
- SMP
 - compiling 25
- source
 - overview 308
- source files
 - editing 19
 - options 30
 - suffixes 15
- source-code conformance
 - checking 4

- source-level debugging support
 - overview 6
- specification
 - command lines 29
 - source files 30
- stack limits
 - fixing 301
- static
 - linking 35
- storage limits
 - fixing 301
- support
 - hardware 3
 - languages 3
 - operating systems 3
- symbolic debugger support
 - overview 6
- system problems
 - fixing 301

T

- temporary file directories
 - specifying 9
- terminology
 - overview 316
- tuning
 - overview 62

U

- utilization tracking
 - SLM Tags introduction 295
 - SLM Tags overview 295
 - SLM Tags setting 296

X

- xlF95_r command
 - for compiling SMP programs 25



Product Number: 5765-J10; 5725-C75

Printed in USA

SC27-6610-04

