

IBM XL Fortran for Linux, V15.14



Optimization and Programming Guide for Little Endian Distributions

Version 15.14

IBM XL Fortran for Linux, V15.14



Optimization and Programming Guide for Little Endian Distributions

Version 15.14

Note

Before using this information and the product it supports, read the information in "Notices" on page 327.

First edition

This edition applies to IBM XL Fortran for Linux, V15.1.4 (Program 5765-J10; 5725-C75) and to all subsequent releases and modifications until otherwise indicated in new editions. Make sure you are using the correct edition for the level of the product.

© Copyright IBM Corporation 1990, 2016.

US Government Users Restricted Rights – Use, duplication or disclosure restricted by GSA ADP Schedule Contract with IBM Corp.

Contents

About this document vii

Who should read this document	vii
How to use this document	vii
How this document is organized	vii
Conventions	viii
Related information	xii
IBM XL Fortran information	xii
Standards and specifications	xiii
Other IBM information	xiv
Technical support	xiv
How to send your comments	xiv

Chapter 1. Optimizing your applications 1

Distinguishing between optimization and tuning	1
Steps in the optimization process	2
Basic optimization	2
Optimizing at level 0	3
Optimizing at level 2	3
Advanced optimization	4
Optimizing at level 3	5
An intermediate step: adding -qhot suboptions at level 3	6
Optimizing at level 4	7
Optimizing at level 5	8
Specialized optimization techniques	8
High-order transformation (HOT)	9
Interprocedural analysis (IPA)	11
Profile-directed feedback	14
Vector technology	22
Using compiler reports to diagnose optimization opportunities	26
Tracing procedures in your code	28
Getting more performance	32
Beyond performance: effective programming techniques	33

Chapter 2. Tuning XL compiler applications 35

Tuning for your target architecture	35
Using -qarch	35
Using -qtune	36
Using -qcache	37
Before you finish tuning	37
Further option driven tuning	37
Options for providing application characteristics	38
Options to control optimization transformations	40
Options to assist with performance analysis	41
Options that can inhibit performance	42

Chapter 3. Advanced optimization concepts 43

Aliasing	43
Inlining	43
Finding the right level of inlining	44

Chapter 4. Managing code size 47

Steps for reducing code size	48
Compiler option influences on code size	48
The -qipa compiler option	48
The -qinline inlining option	48
The -qhot compiler option	49
The -qcompact compiler option	49
Other influences on code size	49
High activity areas	49
Computed GOTOs and CASE constructs	49
Code size with dynamic or static linking	50

Chapter 5. Debugging optimized code 53

Understanding different results in optimized programs	53
Debugging in the presence of optimization	54

Chapter 6. Compiler-friendly programming techniques 57

General practices	57
Variables and pointers	57
Arrays	58
Choosing appropriate variable sizes	58
Submodules (Fortran 2008)	59

Chapter 7. High performance libraries 63

Using the Mathematical Acceleration Subsystem (MASS) libraries	63
Using the scalar library	64
Using the vector libraries	66
Using the SIMD libraries	70
Compiling and linking a program with MASS	74
Using the Basic Linear Algebra Subprograms – BLAS	75
BLAS function syntax	76
Linking the libxlopt library	78

Chapter 8. Parallel programming with XL Fortran 79

Compiling your parallelized code	79
The _OPENMP C preprocessor macro and conditional compilation	79
Setting runtime options	80
XL S M P O P T S	80
Environment variables for OpenMP	85
Optimizing your SMP code	99
Developing and running SMP applications	100
An introduction to parallelization directives	100
Parallel region construct	100
Work-sharing constructs	100
Combined parallel work-sharing constructs	101
Synchronization constructs	101
Other OpenMP directives	101
Non-OpenMP SMP directives	101

Deprecated directive	102	omp_get_place_proc_ids(place_num, ids)	190
Detailed descriptions of parallelization directives	102	omp_get_proc_bind()	190
ATOMIC	102	omp_get_schedule(kind, modifier)	191
BARRIER	108	omp_get_team_size(level)	192
CRITICAL / END CRITICAL	109	omp_get_thread_limit()	192
DO / END DO	111	omp_get_thread_num()	192
DO SERIAL	114	omp_get_wtick()	194
FLUSH	115	omp_get_wtime()	194
MASTER / END MASTER	117	omp_in_final()	195
ORDERED / END ORDERED	119	omp_in_parallel()	195
PARALLEL / END PARALLEL	121	omp_init_lock(svar)	196
PARALLEL DO / END PARALLEL DO	123	omp_init_nest_lock(nvar)	197
PARALLEL SECTIONS / END PARALLEL SECTIONS	127	omp_set_dynamic(enable_expr)	198
PARALLEL WORKSHARE / END PARALLEL WORKSHARE	130	omp_set_lock(svar)	199
SCHEDULE	130	omp_set_max_active_levels(max_levels)	199
SECTIONS / END SECTIONS	133	omp_set_nested(enable_expr)	200
SINGLE / END SINGLE	137	omp_set_nest_lock(nvar)	201
TASK / END TASK	140	omp_set_num_threads(number_of_threads_expr)	202
TASKWAIT	142	omp_set_schedule(kind, modifier)	202
TASKYIELD	143	omp_test_lock(svar)	203
THREADLOCAL	143	omp_test_nest_lock(nvar)	204
THREADPRIVATE	146	omp_unset_lock(svar)	204
WORKSHARE / END WORKSHARE	151	omp_unset_nest_lock(nvar)	205
Data sharing attribute rules	153	Pthreads Library Module	206
Directive clauses	155	Pthreads data structures, functions, and subroutines	207
COLLAPSE	156	f_maketime(delay)	209
COPYIN	159	f_pthread_attr_destroy(attr)	210
COPYPRIVATE	160	f_pthread_attr_getdetachstate(attr, detach)	210
DEFAULT	161	f_pthread_attr_getguardsize(attr, guardsize)	211
FINAL	163	f_pthread_attr_getinheritsched(attr, inherit)	211
FIRSTPRIVATE	163	f_pthread_attr_getschedparam(attr, param)	212
IF	165	f_pthread_attr_getschedpolicy(attr, policy)	213
LASTPRIVATE	165	f_pthread_attr_getscope(attr, scope)	213
MERGEABLE	167	f_pthread_attr_getstack(attr, stackaddr, ssize)	214
NUM_THREADS	168	f_pthread_attr_init(attr)	214
ORDERED	168	f_pthread_attr_setdetachstate(attr, detach)	215
PRIVATE	169	f_pthread_attr_setguardsize(attr, guardsize)	216
PROC_BIND	171	f_pthread_attr_setinheritsched(attr, inherit)	216
REDUCTION	172	f_pthread_attr_setschedparam(attr, param)	217
SCHEDULE	175	f_pthread_attr_setschedpolicy(attr, policy)	217
SHARED	178	f_pthread_attr_setscope(attr, scope)	218
UNTIED	179	f_pthread_attr_setstack(attr, stackaddr, ssize)	219
Routines for OpenMP	180	f_pthread_attr_t	219
omp_destroy_lock(svar)	181	f_pthread_cancel(thread)	220
omp_destroy_nest_lock(nvar)	182	f_pthread_cleanup_pop(exec)	220
omp_get_active_level()	183	f_pthread_cleanup_push(cleanup, flag, arg)	221
omp_get_ancestor_thread_num(level)	183	f_pthread_cond_broadcast(cond)	222
omp_get_dynamic()	183	f_pthread_cond_destroy(cond)	223
omp_get_level()	184	f_pthread_cond_init(cond, cattr)	223
omp_get_max_active_levels()	184	f_pthread_cond_signal(cond)	224
omp_get_max_threads()	185	f_pthread_cond_t	224
omp_get_nested()	185	f_pthread_cond_timedwait(cond, mutex, timeout)	224
omp_get_num_places()	186	f_pthread_cond_wait(cond, mutex)	225
omp_get_num_procs()	186	f_pthread_condattr_destroy(cattr)	226
omp_get_num_threads()	187	f_pthread_condattr_getpshared(cattr, pshared)	226
omp_get_partition_num_places()	188	f_pthread_condattr_init(cattr)	227
omp_get_partition_place_nums(place_nums)	188	f_pthread_condattr_setpshared(cattr, pshared)	227
omp_get_place_num()	189	f_pthread_condattr_t	228
omp_get_place_num_procs(place_num)	189	f_pthread_create(thread, attr, flag, ent, arg)	228

f_thread_detach(thread)	230
f_thread_equal(thread1, thread2)	230
f_thread_exit(ret)	231
f_thread_getconcurrency()	232
f_thread_getschedparam(thread, policy, param)	232
f_thread_getspecific(key, arg)	233
f_thread_join(thread, ret)	233
f_thread_key_create(key, dtr)	234
f_thread_key_delete(key)	235
f_thread_key_t	235
f_thread_kill(thread, sig)	236
f_thread_mutex_destroy(mutex)	236
f_thread_mutex_init(mutex, mattr)	237
f_thread_mutex_lock(mutex)	237
f_thread_mutex_t	238
f_thread_mutex_trylock(mutex)	238
f_thread_mutex_unlock(mutex)	239
f_thread_mutexattr_destroy(mattr)	239
f_thread_mutexattr_getpshared(mattr, pshared)	240
f_thread_mutexattr_gettype(mattr, type)	240
f_thread_mutexattr_init(mattr)	241
f_thread_mutexattr_setpshared(mattr, pshared)	242
f_thread_mutexattr_settype(mattr, type)	242
f_thread_mutexattr_t	243
f_thread_once(once, inthr)	244
f_thread_once_t	244
f_thread_rwlock_destroy(rwlock)	244
f_thread_rwlock_init(rwlock, rwattr)	245
f_thread_rwlock_rdlock(rwlock)	245
f_thread_rwlock_t	246
f_thread_rwlock_tryrdlock(rwlock)	246
f_thread_rwlock_trywrlock(rwlock)	247
f_thread_rwlock_unlock(rwlock)	247
f_thread_rwlock_wrlock(rwlock)	248
f_thread_rwlockattr_destroy(rwattr)	248
f_thread_rwlockattr_getpshared(rwattr, pshared)	249
f_thread_rwlockattr_init(rwattr)	250
f_thread_rwlockattr_setpshared(rwattr, pshared)	250
f_thread_rwlockattr_t	251
f_thread_self()	251
f_thread_setcancelstate(state, oldstate)	252
f_thread_setcanceltype(type, oldtype)	252
f_thread_setconcurrency(new_level)	253
f_thread_setschedparam(thread, policy, param)	254
f_thread_setspecific(key, arg)	254
f_thread_t	255
f_thread_testcancel()	255
f_sched_param	256
f_sched_yield()	256
f_timespec	256
Chapter 9. Interlanguage calls	259
Conventions for XL Fortran external names	259
Mixed-language input and output	260
Mixing Fortran and C++	260
Making calls to C functions work	262
Passing data from one language to another	263
Passing arguments between languages	263
Passing global variables between languages	264

Passing character types between languages	265
Passing arrays between languages	266
Passing pointers between languages	267
Passing arguments by reference or by value	267
Passing COMPLEX values to/from gcc	269
Returning values from Fortran functions	269
Arguments with the OPTIONAL attribute	270
Assembler-level subroutine linkage conventions	270
The stack	272
The Linkage Area and Minimum Stack Frame	273
The input parameter area	274
The register save area	274
The local stack area	274
The output parameter area	274
Linkage convention for argument passing	274
Argument passing rules (by value)	275
Order of arguments in argument list	276
Linkage convention for function calls	277
Pointers to functions	277
Function values	278
The stack floor	278
Stack overflow	278
Prolog and epilog	279
Traceback	279

Chapter 10. Implementation details of XL Fortran Input/Output (I/O) 281

Implementation details of file formats	281
File names	282
Preconnected and implicitly connected files	283
File positioning	284
I/O redirection	284
How XL Fortran I/O interacts with pipes, special files, and links	285
Default record lengths	285
File permissions	285
Selecting error messages and recovery actions	286
Flushing I/O buffers	286
Choosing locations and names for Input/Output files	287
Naming files that are connected with no explicit name	287
Naming scratch files	287
Asynchronous I/O	288
Execution of an asynchronous data transfer operation	289
Usage	289
Performance	291
Compiler-generated temporary I/O items	292
Error handling	292
XL Fortran thread-safe I/O library	293
Synchronization of I/O operations	293
Parallel I/O issues	293
Use of I/O statements in signal handlers	295
Asynchronous thread cancellation	296

Chapter 11. Implementation details of XL Fortran floating-point processing . 297

IEEE floating-point overview	297
Compiling for strict IEEE conformance	297

IEEE single-precision and double-precision values	298
IEEE extended-precision values	298
Infinities and NaNs	298
Exception-handling model	299
Hardware-specific floating-point overview.	300
Single-precision and double-precision values	300
Extended-precision values	301
How XL Fortran rounds floating-point calculations	302
Selecting the rounding mode	302
Minimizing rounding errors	304
Minimizing overall rounding	304
Delaying rounding until run time	304
Ensuring that the rounding mode is consistent	304
Duplicating the floating-point results of other systems	305
Maximizing floating-point performance	305
Detecting and trapping floating-point exceptions	306
Compiler features for trapping floating-point exceptions	306
Installing an exception handler	307
Producing a core file	308
Controlling the floating-point status and control register	308
xlf_fp_util procedures	309
fpgets and fpsets subroutines	309
Sample programs for exception handling	311
Causing exceptions for particular variables	311
Minimizing the performance impact of floating-point exception trapping	311

Chapter 12. Porting programs to XL Fortran	313
Outline of the porting process	313

Portability of directives	313
Common industry extensions that XL Fortran supports	314
Mixing data types in statements	316
Date and time routines	316
Other libc routines	316
Changing the default sizes of data types	316
Name conflicts between your procedures and XL Fortran intrinsic procedures	316
Reproducing results from other systems	316

Chapter 13. Vector element order toggling.	317
Program migration from big endian systems	320

Chapter 14. Sample Fortran programs	321
Example 1 - XL Fortran source file	321
Example 2 - valid C routine source file	321
Example 3 - valid Fortran SMP source file	324
Example 4 - invalid Fortran SMP source file	324
Programming examples using the Pthreads Library Module	325

Notices	327
Trademarks	329

Index	331
------------------------	------------

About this document

This document is part of the IBM® XL Fortran for Linux, V15.1.4 information suite. It provides both reference information and practical tips for using the optimization and tuning capabilities of XL Fortran to maximize application performance, as well as expanding on programming concepts such as I/O and interlanguage calls.

Who should read this document

This document is for anyone who wants to exploit the capabilities of XL Fortran for optimizing and tuning Fortran programs. Readers should be familiar with their Linux operating system and have extensive Fortran programming experience with complex applications. However, users new to XL Fortran can still use this information to help them understand how the compiler's features can be used for effective program optimization.

How to use this document

This guide focuses on specific programming and compilation techniques that can maximize XL Fortran application performance. It covers optimization and tuning strategies, recommended programming practices, and compilation procedures, debugging, and information about using XL Fortran advanced language features. This guide also contains cross-references to relevant topics of other reference guides in the XL Fortran information suite.

Topics not described in this information are available as follows:

- Installation, system requirements, last-minute updates: see the *XL Fortran Installation Guide* and product README file.
- Overview of XL Fortran features: see the *Getting Started with XL Fortran* book.
- Syntax, semantics, and implementation of the XL Fortran programming language: see the *XL Fortran Language Reference* book.
- Compiler setup, compiling and running programs, compiler options, diagnostics: see the *XL Fortran Compiler Reference* book.
- Operating system commands related to the use of the compiler: consult the man page help and information of your Linux distribution.

How this document is organized

This guide includes the following topics:

- Chapter 1, “Optimizing your applications,” on page 1 provides an overview of the optimization process.
- Chapter 2, “Tuning XL compiler applications,” on page 35 discusses the compiler options available for optimizing and tuning code.
- Chapter 3, “Advanced optimization concepts,” on page 43, Chapter 4, “Managing code size,” on page 47, and Chapter 5, “Debugging optimized code,” on page 53 discuss advanced techniques, such as optimizing loops and inlining code, and debug considerations for optimized code.

- The following sections contain information about how to write optimization friendly and portable XL Fortran code that is interoperable with other languages. Also included is a description of XL Fortran support for OpenMP and SMP with guidelines for writing parallel code.
 - Chapter 6, “Compiler-friendly programming techniques,” on page 57
 - Chapter 7, “High performance libraries,” on page 63
 - Chapter 8, “Parallel programming with XL Fortran,” on page 79
 - Chapter 9, “Interlanguage calls,” on page 259
- The following sections contain information about XL Fortran and its implementation that can be useful for new and experienced users alike, as well as those who want to move their existing Fortran applications to the XL Fortran compiler:
 - Chapter 10, “Implementation details of XL Fortran Input/Output (I/O),” on page 281
 - Chapter 11, “Implementation details of XL Fortran floating-point processing,” on page 297
 - Chapter 12, “Porting programs to XL Fortran,” on page 313
 - Chapter 13, “Vector element order toggling,” on page 317
- Chapter 14, “Sample Fortran programs,” on page 321 provides coding examples for XL Fortran.

Conventions

Typographical conventions

The following table shows the typographical conventions used in the IBM XL Fortran for Linux, V15.1.4 information.

Table 1. Typographical conventions

Typeface	Indicates	Example
lowercase bold	Invocation commands, executable names, and compiler options.	The compiler provides basic invocation commands, xlf , along with several other compiler invocation commands to support various Fortran language levels and compilation environments. The default file name for the executable program is a.out .
<i>italics</i>	Parameters or variables whose actual names or values are to be supplied by the user. Italics are also used to introduce new terms.	Make sure that you update the <i>size</i> parameter if you return more than the <i>size</i> requested.
<u>underlining</u>	The default setting of a parameter of a compiler option or directive.	nomaf <u>maf</u>
monospace	Examples of program code, reference to program code, file names, path names, command strings, or user-defined names.	To compile and optimize myprogram.f, enter: xlf myprogram.f -03.











Table 1. *Typographical conventions (continued)*

Typeface	Indicates	Example
UPPERCASE bold	Fortran programming keywords, statements, directives, and intrinsic procedures. Uppercase letters may also be used to indicate the minimum number of characters required to invoke a compiler option/suboption.	The ASSERT directive applies only to the DO loop immediately following the directive, and not to any nested DO loops.

Qualifying elements (icons and bracket separators)

In descriptions of language elements or programming models, this information uses icons and marked bracket separators to delineate segments of text as follows:

Table 2. *Qualifying elements*

Icon	Bracket separator text	Meaning
 F2008  F2008	Fortran 2008 begins / Fortran 2008 ends	The text describes an IBM XL Fortran implementation of the Fortran 2008 standard. ¹
 F2003  F2003	Fortran 2003 begins / Fortran 2003 ends	The text describes an IBM XL Fortran implementation of the Fortran 2003 standard, and it applies to all later standards. ¹
 IBM  IBM	IBM extension begins / IBM extension ends	The text describes a feature that is an IBM XL Fortran extension to the standard language specifications. ¹
 TS 29113  TS 29113	TS 29113 begins / TS 29113 ends	The text describes an IBM XL Fortran implementation of Technical Specification 29113, referred to as TS 29113. ¹
 CUDA Fortran  CUDA Fortran	CUDA Fortran begins / CUDA Fortran ends	The text describes CUDA Fortran, the CUDA Fortran support provided by IBM XL Fortran, or both.

Note:

1. If the information is marked with a Fortran language standard icon or bracket separators, it applies to this specific Fortran language standard and all later ones. Otherwise, it applies to all Fortran language standards.

Syntax diagrams

Throughout this information, diagrams illustrate XL Fortran syntax. This section helps you to interpret and use those diagrams.

- Read the syntax diagrams from left to right, from top to bottom, following the path of the line.

The  symbol indicates the beginning of a command, directive, or statement.

The  symbol indicates that the command, directive, or statement syntax is continued on the next line.

The \blacktriangleright — symbol indicates that a command, directive, or statement is continued from the previous line.

The — \blacktriangleleft symbol indicates the end of a command, directive, or statement.

Fragments, which are diagrams of syntactical units other than complete commands, directives, or statements, start with the \blacktriangleright — symbol and end with the — \blacktriangleleft symbol.

IBM XL Fortran extensions are marked by a number in the syntax diagram with an explanatory note immediately following the diagram.

Program units, procedures, constructs, interface blocks and derived-type definitions consist of several individual statements. For such items, a box encloses the syntax representation, and individual syntax diagrams show the required order for the equivalent Fortran statements.

- Required items are shown on the horizontal line (the main path):



- Optional items are shown below the main path:

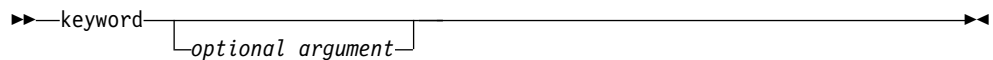

Note: Optional items (not in syntax diagrams) are enclosed by square brackets ([and]). For example, [UNIT=]u

- If you can choose from two or more items, they are shown vertically, in a stack. If you *must* choose one of the items, one item of the stack is shown on the main path.

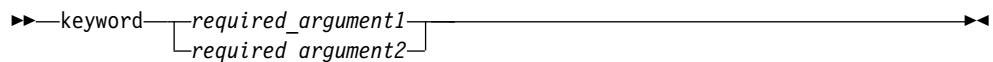

If choosing one of the items is optional, the entire stack is shown below the main path.



- An arrow returning to the left above the main line (a repeat arrow) indicates that you can make more than one choice from the stacked items or repeat an item. The separator character, if it is other than a blank, is also indicated:



- The item that is the default is shown above the main path.



- Keywords are shown in nonitalic letters and should be entered exactly as shown.

- Variables are shown in italicized lowercase letters. They represent user-supplied names or values. If a variable or user-specified name ends in *_list*, you can provide a list of these terms separated by commas.
- If punctuation marks, parentheses, arithmetic operators, or other such symbols are shown, you must enter them as part of the syntax.

Sample syntax diagram

The following is an example of a syntax diagram with an interpretation:

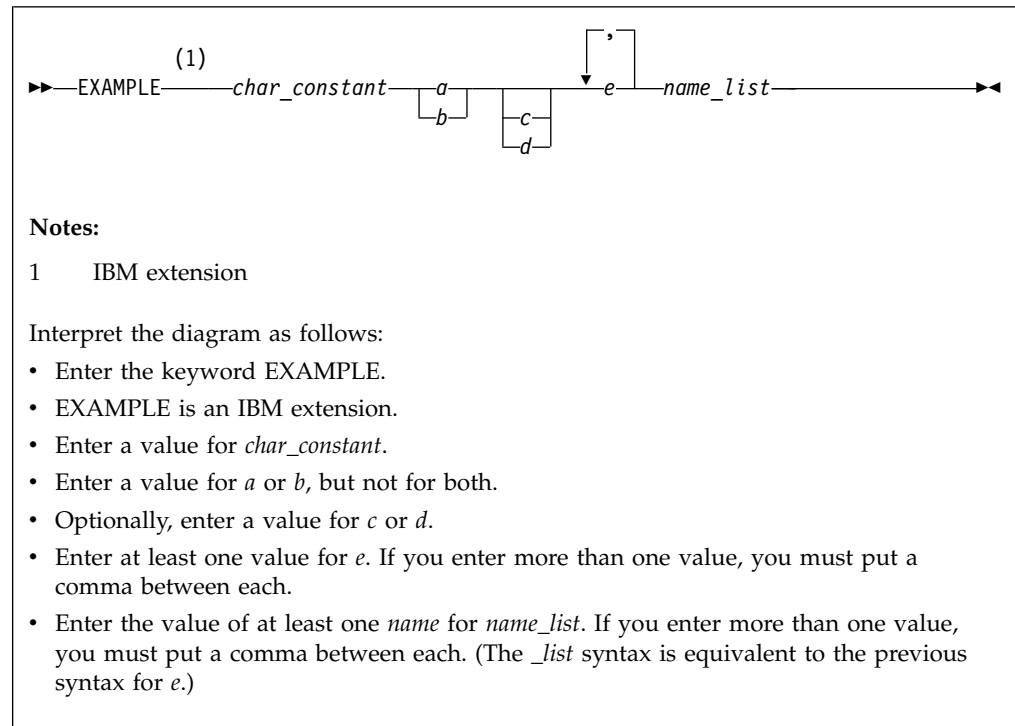

How to read syntax statements

Syntax statements are read from left to right:

- Individual required arguments are shown with no special notation.
- When you must make a choice between a set of alternatives, they are enclosed by { and } symbols.
- Optional arguments are enclosed by [and] symbols.
- When you can select from a group of choices, they are separated by | characters.
- Arguments that you can repeat are followed by ellipses (...).

Example of a syntax statement

EXAMPLE *char_constant* {*a|b*}[*c|d*]*e*[,*e*]... *name_list*{*name_list*}...

The following list explains the syntax statement:

- Enter the keyword EXAMPLE.
- Enter a value for *char_constant*.
- Enter a value for *a* or *b*, but not for both.
- Optionally, enter a value for *c* or *d*.

- Enter at least one value for *e*. If you enter more than one value, you must put a comma between each.
- Optionally, enter the value of at least one *name* for *name_list*. If you enter more than one value, you must put a comma between each *name*.

Note: The same example is used in both the syntax-statement and syntax-diagram representations.

Examples in this information

The examples in this information, except where otherwise noted, are coded in a simple style that does not try to conserve storage, check for errors, achieve fast performance, or demonstrate all possible methods to achieve a specific result.

The examples for installation information are labelled as either *Example* or *Basic example*. *Basic examples* are intended to document a procedure as it would be performed during a basic, or default, installation; these need little or no modification.

Notes on the terminology used

Some of the terminology in this information is shortened as follows:

- The term *free source form format* often appears as *free source form*.
- The term *fixed source form format* often appears as *fixed source form*.
- The term *XL Fortran* often appears as *XLF*.

Related information

The following sections provide related information for XL Fortran:

IBM XL Fortran information

XL Fortran provides product information in the following formats:

- Quick Start Guide

The Quick Start Guide (`quickstart.pdf`) is intended to get you started with IBM XL Fortran for Linux, V15.1.4. It is located by default in the XL Fortran directory and in the `\quickstart` directory of the installation DVD.
- README files

README files contain late-breaking information, including changes and corrections to the product information. README files are located by default in the XL Fortran directory, and in the root directory and subdirectories of the installation DVD.
- Installable man pages

Man pages are provided for the compiler invocations and all command-line utilities provided with the product. Instructions for installing and accessing the man pages are provided in the *IBM XL Fortran for Linux, V15.1.4 Installation Guide*.
- Online product documentation

The fully searchable HTML-based documentation is viewable in IBM Knowledge Center at http://www.ibm.com/support/knowledgecenter/SSAT4T_15.1.4/com.ibm.compilers.linux.doc/welcome.html.
- PDF documents

PDF documents are available on the web at <http://www.ibm.com/support/docview.wss?uid=swg27036672>.

The following files comprise the full set of XL Fortran product information:

Table 3. XL Fortran PDF files

Document title	PDF file name	Description
<i>IBM XL Fortran for Linux, V15.1.4 Installation Guide, GC27-6580-03</i>	install.pdf	Contains information for installing XL Fortran and configuring your environment for basic compilation and program execution.
<i>Getting Started with IBM XL Fortran for Linux, V15.1.4, SC27-6620-03</i>	getstart.pdf	Contains an introduction to the XL Fortran product, with information about setting up and configuring your environment, compiling and linking programs, and troubleshooting compilation errors.
<i>IBM XL Fortran for Linux, V15.1.4 Compiler Reference, SC27-6610-03</i>	compiler.pdf	Contains information about the various compiler options and environment variables.
<i>IBM XL Fortran for Linux, V15.1.4 Language Reference, SC27-6590-03</i>	langref.pdf	Contains information about the Fortran programming language as supported by IBM, including language extensions for portability and conformance to nonproprietary standards, compiler directives and intrinsic procedures.
<i>IBM XL Fortran for Linux, V15.1.4 Optimization and Programming Guide, SC27-6600-03</i>	proguide.pdf	Contains information on advanced programming topics, such as application porting, interlanguage calls, floating-point operations, input/output, application optimization and parallelization, and the XL Fortran high-performance libraries.
<i>Getting Started with CUDA Fortran programming using IBM XL Fortran for Linux, V15.1.4, GI13-3562-00</i>	getstart_cudaf.pdf	Contains detailed information about the CUDA Fortran support that is provided in XL Fortran, including the compiler flow for CUDA Fortran programs, compilation commands, useful compiler options and macros, supported CUDA Fortran features, and limitations.

To read a PDF file, use Adobe Reader. If you do not have Adobe Reader, you can download it (subject to license terms) from the Adobe website at <http://www.adobe.com>.

More information related to XL Fortran, including IBM Redbooks® publications, white papers, and other articles, is available on the web at <http://www.ibm.com/support/docview.wss?uid=swg27036672>.

For more information about the compiler, see the XL compiler on Power® community at <http://ibm.biz/xl-power-compilers>.

Standards and specifications

XL Fortran is designed to support the following standards and specifications. You can refer to these standards and specifications for precise definitions of some of the features found in this information.

- *American National Standard Programming Language FORTRAN, ANSI X3.9-1978.*

- *American National Standard Programming Language Fortran 90, ANSI X3.198-1992.*
- *ANSI/IEEE Standard for Binary Floating-Point Arithmetic, ANSI/IEEE Std 754-1985.*
- *Federal (USA) Information Processing Standards Publication Fortran, FIPS PUB 69-1.*
- *Information technology - Programming languages - Fortran, ISO/IEC 1539-1:1991. (This information uses its informal name, Fortran 90.)*
- *Information technology - Programming languages - Fortran - Part 1: Base language, ISO/IEC 1539-1:1997. (This information uses its informal name, Fortran 95.)*
- *Information technology - Programming languages - Fortran - Part 1: Base language, ISO/IEC 1539-1:2004. (This information uses its informal name, Fortran 2003.)*
- *Information technology - Programming languages - Fortran - Part 1: Base language, ISO/IEC 1539-1:2010. (This information uses its informal name, Fortran 2008. We currently provide partial support to this standard.)*
- *Information technology - Further interoperability of Fortran with C, ISO/IEC TS 29113:2012. (This information uses its informal name, Technical specification 29113, referred to as TS 29113. We currently provide partial support to this specification.)*
- *Military Standard Fortran DOD Supplement to ANSI X3.9-1978, MIL-STD-1753 (United States of America, Department of Defense standard). Note that XL Fortran supports only those extensions documented in this standard that have also been subsequently incorporated into the Fortran 90 standard.*
- *OpenMP Application Program Interface Version 3.1 (full support), OpenMP Application Program Interface Version 4.0 (partial support), and OpenMP Application Program Interface Version 4.5 (partial support), available at <http://www.openmp.org>*

Other IBM information

- *ESSL product documentation available at http://www.ibm.com/support/knowledgecenter/SSFHY8/essl_welcome.html?lang=en*

Technical support

Additional technical support is available from the XL Fortran Support page at http://www.ibm.com/support/entry/portal/product/rational/xl_fortran_for_linux. This page provides a portal with search capabilities to a large selection of Technotes and other support information.

If you cannot find what you need, you can send an email to compinfo@cn.ibm.com.

For the latest information about XL Fortran, visit the product information site at <http://ibm.biz/xlfortran-linux>.

How to send your comments

Your feedback is important in helping us to provide accurate and high-quality information. If you have any comments about this information or any other XL Fortran information, send your comments to compinfo@cn.ibm.com.

Be sure to include the name of the manual, the part number of the manual, the version of XL Fortran, and, if applicable, the specific location of the text you are commenting on (for example, a page number or table number).

Chapter 1. Optimizing your applications

The XL compilers enable development of high performance applications by offering a comprehensive set of performance enhancing techniques that exploit the multilayered PowerPC® architecture. These performance advantages depend on good programming techniques, thorough testing and debugging, followed by optimization, and tuning.

Distinguishing between optimization and tuning

You can use optimization and tuning separately or in combination to increase the performance of your application. Understanding the difference between them is the first step in understanding how the different levels, settings, and techniques can increase performance.

Optimization

Optimization is a compiler-driven process that searches for opportunities to restructure your source code and give your application better overall performance at run time, without significantly impacting development time. The XL compiler optimization suite, which you control using compiler options and directives, performs best on well-written source code that has already been through a thorough debugging and testing process. These optimization transformations can bring the following benefits:

- Reduce the number of instructions that your application executes to perform critical operations.
- Restructure your object code to make optimal use of the PowerPC architecture.
- Improve memory subsystem usage.
- Exploit the ability of the architecture to handle large amounts of shared memory parallelization.

Each basic optimization technique can result in a performance benefit, although not all optimizations can benefit all applications. Consult the “Steps in the optimization process” on page 2 for an overview of the common sequence of steps that you can use to increase the performance of your application.

Tuning

Tuning is a user-driven process where you experiment with changes, for example to source code or compiler options, to make the compiler better optimize your program. While optimization applies general transformations designed to improve the performance of any application in any supported environment, tuning offers you opportunities to adjust specific characteristics or target execution environments of your application to improve its performance. Even at low optimization levels, tuning for your application and target architecture can have a positive impact on performance. With proper tuning, the compiler can make the following improvements:

- Select more efficient machine instructions.
- Generate instruction sequences that are more relevant to your application.
- Select from more focussed optimizations to improve your code.

For instructions, see Tuning XL compiler applications.

Steps in the optimization process

When you begin the optimization process, consider that not all optimization techniques suit all applications. Trade-offs sometimes occur between an increase in compile time, a reduction in debugging capability, and the improvements that optimization can provide.

Learning about and experimenting with different optimization techniques can help you strike the right balance for your XL compiler applications while achieving the best possible performance. Also, though it is unnecessary to hand-optimize your code, compiler-friendly programming can be extremely beneficial to the optimization process. Unusual constructs can obscure the characteristics of your application and make performance optimization difficult. Use the steps in this section as a guide for optimizing your application.

1. The Basic optimization step begins your optimization processes at levels 0 and 2.
2. The Advanced optimization step exposes your application to more intense optimizations at levels 3, 4, and 5.
3. The High-order transformation (HOT) step can help you reduce loop execution time.
4. The Interprocedural analysis (IPA) step can optimize your entire application at once.
5. The Profile-directed feedback (PDF) step focuses optimizations on specific characteristics of your application.
6. The Debugging optimized code step can help you identify issues and problems that can occur with optimized code.
7. The Getting more performance section offers other strategies and tuning alternatives to compiler-driven optimization.

The section Compiler-friendly programming techniques contains tips for writing more easily optimized source code.

Basic optimization

The XL compiler supports several levels of optimization, with each option level building on the levels below through increasingly aggressive transformations and consequently using more machine resources.

Ensure that your application compiles and executes properly at low optimization levels before you try more aggressive optimizations. This topic discusses two optimizations levels, listed with complementary options in Table 4. The table also includes a column for compiler options that can have a performance benefit at that optimization level for some applications.

Table 4. Basic optimizations

Optimization level	Additional options implied by default	Complementary options	Other options with possible benefits
-O0	None	-qarch	None
-O2	-qmaxmem=8192	-qarch -qtune	-qmaxmem=-1 -qhot=level=0

Note: Specifying `-O` without including a level implies `-O2`.

Optimizing at level 0

Benefits at level 0

- Provides minimal performance improvement with minimal impact on machine resources
- Exposes some source code problems that can be helpful in the debugging process

Begin your optimization process at `-O0`, which the compiler already specifies by default. This level performs basic analytical optimization by removing obviously redundant code, and it can result in better compile time. It also ensures your code is algorithmically correct so you can move forward to more complex optimizations. `-O0` also includes some redundant instruction elimination and constant folding. The `-qfloat=nofold` option can be used to suppress folding floating-point operations. Optimizing at this level accurately preserves all debugging information and can expose problems in existing code, such as uninitialized variables.

Additionally, specifying `-qarch` at this level targets your application for a particular machine and can significantly improve performance by ensuring that your application takes advantage of all applicable architectural benefits.

Note: For SMP programs, you need to add an additional option `-qsmp=noopt`.

For more information about tuning, consult *Tuning for Your Target Architecture*.

See `"-O"` in the *XL Fortran Compiler Reference* for information about the `-O` level syntax.

Related information in the *XL Fortran Compiler Reference*

 `-qarch`

Optimizing at level 2

Benefits at level 2

- Eliminates redundant code
- Performs basic loop optimization
- Structures code to take advantage of `-qarch` and `-qtune` settings

After you successfully compile, execute, and debug your application using `-O0`, recompiling at `-O2` opens your application to a set of comprehensive low-level transformations that apply to subprogram or compilation unit scopes and can include some inlining. Optimizations at `-O2` attain a relative balance between increasing performance while limiting the impact on compilation time and system resources. You can increase the memory available to some of the optimizations in the `-O2` portfolio by providing a larger value for the `-qmaxmem` option. Specifying `-qmaxmem=-1` allows the optimizer to use memory as needed without checking for limits but does not change the transformations the optimizer applies to your application at `-O2`.

Starting to tune at level 2

Choosing the right hardware architecture target or family of targets becomes even more important at `-O2` and higher. By targeting the proper hardware, the optimizer can make the best use of the available hardware facilities. If you choose a family of

hardware targets, the **-qtune** option can direct the compiler to emit code that is consistent with the architecture choice and that can execute optimally on the chosen tuning hardware target. With this option, you can compile for a general set of targets and have the code run best on a particular target.

For details on the **-qarch** and **-qtune** options, see Chapter 2, “Tuning XL compiler applications,” on page 35.

The **-O2** option can perform a number of additional optimizations as follows:

- Common subexpression elimination: Eliminates redundant instructions
- Constant propagation: Evaluates constant expressions at compile time
- Dead code elimination: Eliminates instructions that a particular control flow does not reach or that generate an unused result
- Dead store elimination: Eliminates unnecessary variable assignments
- Global register allocation: Globally assigns user variables to registers
- Value numbering: Simplifies algebraic expressions by eliminating redundant computations
- Instruction scheduling for the target machine
- Loop unrolling and software pipelining
- Moving loop-invariant code out of loops
- Simplifying control flow
- Strength reduction and effective use of addressing modes
- Widening: Merges adjacent load/stores and other operations
- Pointer aliasing improvements to enhance other optimizations

Even with **-O2** optimizations, some useful information about your source code is made available to the debugger if you specify **-g**. Using a higher **-g** level increases the information provided to the debugger but reduces the optimization that can be done. Conversely, higher optimization levels can transform code to an extent to which debugging information is no longer accurate.

The section on Chapter 5, “Debugging optimized code,” on page 53 discusses other debugging strategies in detail.

See “-O” in the *XL Fortran Compiler Reference* for information on the **-O** level syntax.

Advanced optimization

Higher optimization levels can have a tremendous impact on performance, but some trade-offs can occur in terms of code size, compile time, resource requirements, and numeric or algorithmic precision.

After applying “Basic optimization” on page 2 and successfully compiling and executing your application, you can apply more powerful optimization tools. The XL compiler optimization portfolio includes many options for directing advanced optimization, and the transformations that your application undergoes are largely under your control. The discussion of each optimization level in Table 5 on page 5 includes information on the performance benefits and the possible trade-offs and information on how you can help guide the optimizer to find the best solutions for your application.

Table 5. Advanced optimizations

Optimization Level	Additional options implied	Complementary options	Options with possible benefits
-O3 -Ofast	-qnostrict -qmaxmem=-1 -qhot	-qarch -qtune	-qpdf
-O4	All of -O3 -qipa -qarch=auto -qtune=auto -qcache=auto	-qarch -qtune -qcache	-qpdf -qsmp=auto
-O5	All of -O4 -qipa=level=2	-qarch -qtune -qcache	-qpdf -qsmp=auto

When you compile programs with any of the following sets of options:

- **-qhot -qnostrict**
- **-Ofast**
- **-O3**
- **-O4**
- **-O5**

the compiler automatically attempts to vectorize calls to system math functions by calling the equivalent vector functions in the Mathematical Acceleration Subsystem libraries (MASS), with the exceptions of functions `vatan2`, `vsatan2`, `vdnint`, `vdint`, `vcosisin`, `vscosisin`, `vqdrct`, `vsqdrct`, `vrqdrct`, `vsrqdrct`, `vpopcnt4`, and `vpopcnt8`. If the compiler cannot vectorize, it automatically tries to call the equivalent MASS scalar functions. For automatic vectorization or scalarization, the compiler uses versions of the MASS functions contained in the system library `libxlopt.a`.

In addition to any of the preceding sets of options, when the **-qipa** option is in effect, if the compiler cannot vectorize, it tries to inline the MASS scalar functions before deciding to call them.

Optimizing at level 3

Benefits at level 3

- In-depth “Aliasing” on page 43 analysis
- Better loop scheduling
- High-order loop analysis and transformations (**-qhot=level=1**)
- Inlining of small procedures within a compilation unit by default
- Eliminating implicit compile-time memory usage limits

Specifying **-O3** initiates more intense low-level transformations that remove many of the limitations present at **-O2**. For instance, the optimizer no longer checks for memory limits, by setting the default to **-qmaxmem=-1**. Additionally, optimizations encompass larger program regions and attempt more in-depth analysis. Although not all applications contain opportunities for the optimizer to provide a measurable increase in performance, most applications can benefit from this type of analysis. Specifying **-O3** also implies **-qhot**, which performs the default set of high-order transformations.

Potential trade-offs at level 3

With the in-depth analysis of **-O3** comes a trade-off in terms of compilation time and memory resources. Also, because **-O3** implies **-qnostrict**, the optimizer can alter certain floating-point semantics in your application to gain execution speed. This typically involves precision trade-offs as follows:

- Reordering of floating-point computations
- Reordering or elimination of possible exceptions, such as division by zero or overflow
- Using alternative calculations that might give slightly less precise results or not handle infinities or NaNs in the same way

You can still gain most of the **-O3** benefits while preserving precise floating-point semantics by specifying **-qstrict**. Compiling with **-qstrict** is necessary if you require the same absolute precision in floating-point computational accuracy as you get with **-O0**, **-O2**, or **-qnoot** results. The option **-qstrict=ieee** also ensures adherence to all IEEE semantics for floating-point operations. If your application is sensitive to floating-point exceptions or the order of evaluation for floating-point arithmetic, compiling with **-qstrict**, **-qstrict=exceptions**, or **-qstrict=order** helps to ensure accurate results. You should also consider the impact of the **-qstrict=precision** suboption group on floating-point computational accuracy. The precision suboption group includes the individual suboptions: **subnormals**, **operationprecision**, **association**, **reductionorder**, and **library** (described in the **-qstrict** option in the *XL Fortran Compiler Reference*).

Without **-qstrict**, the difference in computation for any one source-level operation is very small in comparison to “Basic optimization” on page 2. Although a small difference can be compounded if the operation is in a loop structure where the difference becomes additive, most applications are not sensitive to the changes that can occur in floating-point semantics.

For information about the **-O** level syntax, see “-O” in the *XL Fortran Compiler Reference*.

An intermediate step: adding **-qhot** suboptions at level 3

At **-O3**, the optimization implies **-qhot=level=1** to increase performance. To further increase your performance benefit from **-qhot**, increase the optimization aggressiveness by increasing the optimization level of **-qhot**.

The following **-qhot** suboption can also provide additional performance benefits, depending on the characteristics of your application:

- **-qhot=arraypad** to enable array padding

For more information about **-qhot**, see “High-order transformation (HOT)” on page 9.

Conversely, if the application does not use loops processing arrays, which **-qhot** improves, you can improve compile speed significantly, usually with minimal performance loss by using **-qnohot** after **-O3**.

Optimizing at level 4

Benefits at level 4

- Propagation of global and argument values between compilation units
- Inlining code from one compilation unit to another
- Reorganization or elimination of global data structures
- An increase in the precision of aliasing analysis

Optimizing at **-O4** builds on **-O3** by triggering **-qipa=level=1**, which performs interprocedural analysis (IPA), optimizing your entire application as a unit. This option is particularly pertinent to applications that contain a large number of frequently used routines.

To make full use of IPA optimizations, you must specify **-O4** on the compilation and link steps of your application build as interprocedural analysis occurs in stages at both compile time and link time.

Beyond **-qipa**, **-O4** enables other optimization options:

- **-qhot**
Enables more aggressive HOT transformations to optimize loop constructs and array language.
- **-qhot=vector**
Optimizes array data to run mathematical operations in parallel where applicable.
- **-qarch=auto** and **-qtune=auto**
Optimizes your application to execute on a hardware architecture identical to your build machine. If the architecture of your build machine is incompatible with the execution environment of your application, you must specify a different **-qarch** suboption after the **-O4** option. This overrides **-qtune=auto**.
- **-qcache=auto**
Optimizes your cache configuration for execution on specific hardware architecture. The **auto** suboption assumes that the cache configuration of your build machine is identical to the configuration of your execution architecture. Specifying a cache configuration can increase program performance, particularly loop operations by blocking them to process only the amount of data that can fit into the data cache at a time.

If you want to execute your application on a different machine, specify correct cache values.

Potential trade-offs at level 4

In addition to the trade-offs already mentioned for **-O3**, specifying **-qipa** can significantly increase compilation time, especially at the link step.

See "-O" in the *XL Fortran Compiler Reference* for information about the **-O** level syntax.

The IPA process

1. At compile time optimizations occur on a file-by-file basis, as well as preparation for the link stage. IPA writes analysis information directly into the object files the compiler produces.
2. At the link stage, IPA reads the information from the object files and analyzes the entire application.

3. This analysis guides the optimizer on how to rewrite and restructure your application and apply appropriate **-O3** level optimizations.

The “Interprocedural analysis (IPA)” on page 11 section contains more information about IPA including details on IPA suboptions.

Optimizing at level 5

Benefits at level 5

- Makes most aggressive optimizations available
- Makes full use of loop optimizations and “Interprocedural analysis (IPA)” on page 11

As the highest optimization level, **-O5** includes all **-O4** optimizations and deepens whole program analysis by increasing the **-qipa** level to 2. Compiling with **-O5** also increases how aggressively the optimizer pursues aliasing improvements. Additionally, if your application contains a mix of C/C++ and Fortran code that you compile using the XL compilers, you can increase performance by compiling and linking your code with the **-O5** option.

Potential trade-offs at level 5

Compiling at **-O5** requires more compilation time and machine resources than any other optimization levels, particularly if you include **-O5** on the IPA link step. Compile at **-O5** as the final phase in your optimization process after successfully compiling and executing your application at **-O4**.

See “-O” in the *XL Fortran Compiler Reference* for information on the **-O** level syntax.

Specialized optimization techniques

While some optimization techniques are active at advanced optimization levels, certain types of applications can receive a performance benefit even when you apply only basic optimizations.

Table 6. Specialized optimization techniques

Technique	Benefit
HOT	Minimizes loop execution time which is beneficial to most applications that contain large loops, or many small loops. HOT also improves memory access patterns in your application.
IPA	Performs whole program analysis, providing the optimization suite with a complete view of your entire application. This applies performance enhancements with more focus and robustness.
PDF	Targets the code paths your application executes most frequently for optimization.

Table 6. Specialized optimization techniques (continued)

Technique	Benefit
Vector technology	Vector technology is a PowerPC technology for accelerating the performance-driven, high-bandwidth communications and computing applications. You can use the vector technology to get dramatic performance improvement for your applications.
Compiler reports	You can use the -qlistfmt option to generate a compiler report in XML 1.0 format that indicates some of the details of how your program was optimized. You can use this information to understand your application code and to tune your code for better performance.

High-order transformation (HOT)

As part of the XL compiler optimization suite, the HOT transformations focus specifically on loops which typically account for the majority of the execution time for most applications. HOT transformations perform in-depth loop analysis to minimize their execution time.

Loop optimization analysis includes:

- Interchange
- Fusion
- Unrolling loop nests
- Reducing the use of temporary arrays

The goals of these optimizations include:

- Reducing memory access costs through effective cache use and translation look-aside buffers (TLBs). Increasing memory locality reduces cache and TLB misses.
- Overlapping computation and memory access through effective utilization of the hardware data prefetching capabilities.
- Improving processor resource utilization by reordering and balancing the use of instructions with complementary resource requirements. Loop computation balance typically involves creating an equitable relationship between load/store operations and floating-point computations.

Compiling with **-O3** and higher triggers HOT transformations by default. You can also see performance benefits by specifying **-qhot** with **-O2**, or adding more **-qhot** optimizations than the default **level=0** at **-O3**.

You can see particular **-qhot** benefits if your application contains Fortran 90-style array language constructs, as HOT transformations include elimination of intermediate temporary variables and statement fusion.

You can also use directives to assist in loop analysis. Assertive directives such as **INDEPENDENT** or **CNCALL** allow you to describe important loop characteristics or behaviors that HOT transformations can exploit. Prescriptive directives such as **UNROLL** or **PREFETCH** allow you to direct the HOT transformations on a loop-by-loop basis. You can also specify the **-qreport** compiler option to generate

information about loop transformations. The report can assist you in deciding where best to include directives to improve the performance of your application. For example, you can use this section of the listing to identify non-stride-one references that may prevent loop vectorization.

You can use the **-qreport** option in conjunction with **-qhot** or any optimization option that implies **-qhot** to produce a pseudo-Fortran report showing how the loops were transformed. The LOOP TRANSFORMATION SECTION of the listing file also contains information about data prefetch insertion locations.

When used with **-qsmp**, **-qhot=level=2** instructs the compiler to perform the transformations of **-qhot=level=1** plus some additional transformation on nested loops. The resulting loop analysis and transformations can lead to more cache reuse and loop parallelization. If you use **-qhot=level=2** and **-qsmp** together with **-qreport** or **-qlistfmt**, you can see this information on aggressive loop analysis performed on loop nests in the LOOP TRANSFORMATION SECTION of the listing file or compiler report.

When you use **-qprefetch=assistthread** to generate prefetching assist threads, a message Assist thread for data prefetching was generated also appears in the LOOP TRANSFORMATION SECTION of the listing file. For details, see **-qprefetch** in the *XL Fortran Compiler Reference*.

With the **-qassert=refalign** suboption, the compiler might generate more efficient code. This assertion is particularly useful when you target a Single Instruction Multiple Data (SIMD) architecture with **-qhot=level=0** or **-qhot=level=1** with the **-qsimd=auto** option.

In addition to general loop transformation, **-qhot** supports suboptions that you can specify to enable additional transformations detailed in this section.

HOT short vectorization

When you are targeting a PowerPC processor that supports Vector Multimedia Extension (VMX) or Vector Scalar Extension (VSX), you can specify **-qsimd=auto** to enable the compiler to transform code into VMX or VSX instructions. These machine instructions can execute up to sixteen operations in parallel. This transformation mostly applies to the loops that iterate over contiguous array data and perform calculations on each element. You can use the **NOSIMD** directive to prevent the transformation of a particular loop.

HOT long vectorization

When you specify any of the following:

- **-O4** and higher
- **-qhot** with **-qnostrict**

you enable **-qhot=vector** by default. Specifying **-qnostrict** with optimizations other than **-O4** and **-O5** ensures that the compiler looks for long vectorization opportunities. This can optimize loops in source code for operations on array data by ensuring that operations run in parallel where applicable. The compiler uses standard machine registers for these transformations and does not restrict vector data size; supporting both single- and double-precision floating-point vectorization. Often, HOT vectorization involves transformations of loop calculations into calls to specialized mathematical routines supplied with the compiler such as the Mathematical Acceleration Subsystem (MASS) libraries. These mathematical routines use algorithms that calculate results more efficiently than executing the original loop code.

For more information about optimization levels like **-O4** and the other compiler options they imply, see “Advanced optimization” on page 4.

HOT array size adjustment

An array dimension that is a power of two can lead to a decrease in cache utilization. The **-qhot=arraypad** suboption allows the compiler to increase the dimensions of arrays where doing so could improve the efficiency of array-processing loops. Using this suboption can reduce cache misses and page faults that slow your array processing programs. The HOT transformations will not necessarily pad all arrays, and can pad different arrays by different amounts in order to gain performance. You can specify a padding factor to apply to all arrays. This value is typically a multiple of the largest array element size.

Use **-qhot=arraypad** with discretion as array padding uses more memory and the performance trade-off does not benefit all applications. Also, these HOT transformations do not include checks for array data overlay, as with Fortran **EQUIVALENCE**, or array shaping operations.

HOT fast scalar math routines

The XLOPT library contains faster versions of certain math functions that are normally provided by the operating system or in the default run time. With **-qhot=fastmath**, the compiler replaces calls to the math functions with their faster counterparts in XLOPT library. This option requires **-qstrict=nolibrary** in effect.

Interprocedural analysis (IPA)

Interprocedural Analysis (IPA) can analyze and optimize your application as a whole, rather than on a file-by-file basis.

Run during the link step of an application build, the entire application, including linked libraries, is available for interprocedural analysis. This whole program analysis opens your application to a powerful set of transformations available only when more than one file or compilation unit is accessible. IPA optimizations are also effective on mixed language applications.

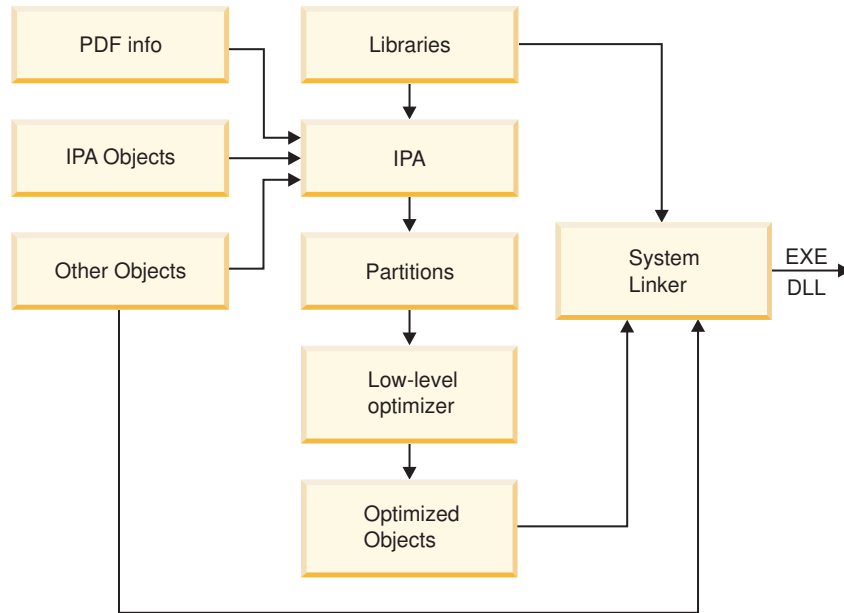

Figure 1. IPA at the link step

The following are some of the link-time transformations that IPA can use to restructure and optimize your application:

- Inlining between compilation units.
- Complex data flow analyses across subprogram calls to eliminate parameters or propagate constants directly into called subprograms.
- Improving parameter usage analysis, or replacing external subprogram calls to system libraries with more efficient inline code.
- Restructuring data structures to maximize access locality.
- Cloning subprograms where calls pass constant parameters to allow optimizing expressions using those parameters.

In order to maximize IPA link-time optimization, you must use IPA at both the compile and link step. Objects you do not compile with IPA can only provide minimal information to the optimizer, and receive minimal benefit. However when IPA is active on the compile step, the resulting object file contains program information that IPA can read during the link step. The program information is invisible to the system linker, and you can still use the object file and link without invoking IPA. The IPA optimizations use hidden information to reconstruct the original compilation and can completely analyze the subprograms the object contains in the context of their actual usage in your application.

During the link step, IPA restructures your application, partitioning it into distinct logical code units. After IPA optimizations are complete, IPA applies the same low-level compilation-unit transformations as the `-O2` and `-O3` base optimization levels. Following those transformations, the compiler creates one or more object files and linking occurs with the necessary libraries through the system linker.

It is important that you specify a set of compilation options as consistent as possible when compiling and linking your application. This includes all compiler options, not just `-qipa` suboptions. When possible, specify identical options on all compilations and repeat the same options on the IPA link step. Incompatible or

conflicting options that you specify to create object files, or link-time options in conflict with compile-time options can reduce the effectiveness of IPA optimizations.

Using IPA on the compile step only

IPA can still perform transformations if you do not specify IPA on the link step. Using IPA on the compile step initiates optimizations that can improve performance for an individual object file even if you do not link the object file using IPA. The primary focus of IPA is link-step optimization, but using IPA only on the compile-step can still be beneficial to your application without incurring the costs of link-time IPA.

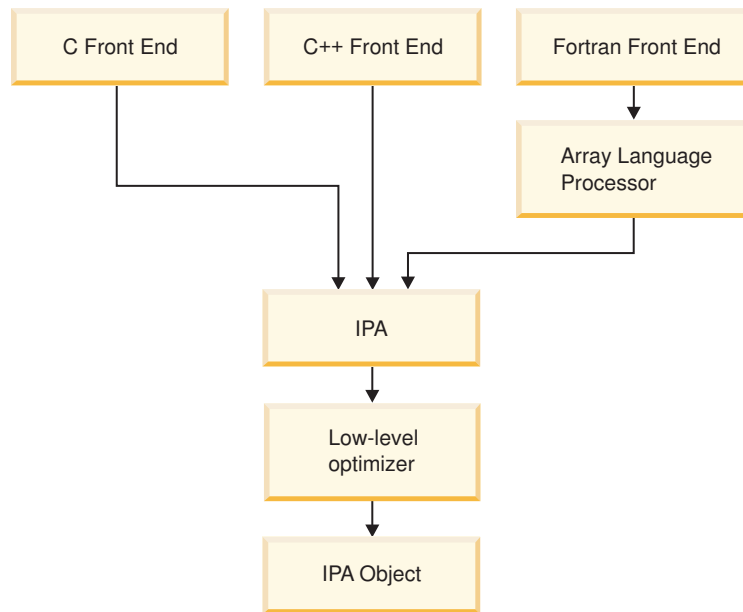

Figure 2. IPA at the compile step

IPA Levels and other IPA suboptions

You can control many IPA optimization functions using the **-qipa** option and suboptions. The most important part of the IPA optimization process is the level at which IPA optimization occurs. Default compilation does not invoke IPA. If you specify **-qipa** without a level, or specify **-O4**, IPA optimizations are at level one. If you specify **-O5**, IPA optimizations are at level two.

Table 7. The levels of IPA

IPA Level	Behaviors
qipa=level=0	<ul style="list-style-type: none"> Automatically recognizes standard library functions Localizes statically bound variables and procedures Organizes and partitions your code according to call affinity, expanding the scope of the -O2 and -O3 low-level compilation unit optimizer Lowers compilation time in comparison to higher levels, though limits analysis

Table 7. The levels of IPA (continued)

IPA Level	Behaviors
<code>qipa=level=1</code>	<ul style="list-style-type: none"> • Level 0 optimizations • Performs procedure inlining across compilation units • Organizes and partitions static data according to reference affinity
<code>qipa=level=2</code>	<ul style="list-style-type: none"> • Level 0 and level 1 optimizations • Performs whole program alias analysis which removes ambiguity between pointer references and calls, while refining call side effect information • Propagates interprocedural constants • Eliminates dead code • Performs pointer analysis • Performs procedure cloning • Optimizes intraprocedural operations, using specifically: <ul style="list-style-type: none"> – Value numbering – Code propagation and simplification – Code motion, into conditions and out of loops – Redundancy elimination techniques • Performs data reorganization

IPA includes many suboptions that can help you guide IPA to perform optimizations important to the particular characteristics of your application. Among the most relevant to providing information on your application are:

- **lowfreq**, with which you can specify a list of procedures that are likely to be called infrequently during the course of a typical program run. Performance can increase because optimization transformations will not focus on these procedures.
- **partition**, with which you can specify the size of the regions within the program to analyze. Larger partitions contain more procedures, which result in better interprocedural analysis but require more storage to optimize.
- **threads**, with which you can specify the number of parallel threads available to IPA optimizations. This can provide an increase in compilation-time performance on multi-processor systems.

Using IPA across the XL compiler family

The XL compiler family shares optimization technology. Object files you create using IPA on the compile step with the XL C, C++, and Fortran compilers can undergo IPA analysis during the link step. Where program analysis shows that objects were built with compatible options, such as `-qnostrict`, IPA can perform transformations such as inlining C functions into Fortran code, or propagating C++ constant data into C function calls.

Profile-directed feedback

You can use profile-directed feedback (PDF) to tune the performance of your application for a typical usage scenario. The compiler optimizes the application based on an analysis of how often branches are taken and blocks of code are run.

Use the PDF process as one of the last steps of optimization before you put the application into production. Optimization at all levels from `-O2` up can benefit

from PDF. Other optimizations such as the **-qipa** option and optimization levels **-O4** and **-O5** can also benefit from PDF process.

The following diagram illustrates the PDF process.

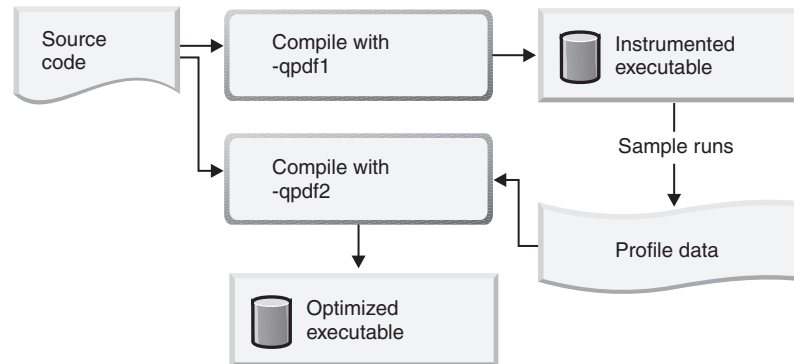

Figure 3. Profile-directed feedback



To use the PDF process to optimize your application, follow these steps:

1. “Compiling with **-qpdf1**”
2. “Training with typical data sets” on page 16
3. “Recompiling or linking with **-qpdf2**” on page 19

Related information in the XL Fortran Compiler Reference

-  **-qpdf1, -qpdf2**
-  **-O, -qoptimize**
-  **-qipa**

Compiling with **-qpdf1**

Compile some or all of the source files in a program with the **-qpdf1** option. This step is called the PDF1 step.

Usage

You do not have to compile all of the files of the programs with the **-qpdf1** option. In a large application, you can concentrate on those areas of the code that can benefit most from the optimization.

When you compile multiple programs with **-qpdf1**, you must ensure that the PDF file that is to be generated in the PDF2 step has a different name for each program because each PDF file can contain data for only one application. Otherwise, if the PDF file names of multiple programs are the same, you can run the first application in the PDF training step and write profile information into the PDF file successfully. However, if you try to run the second application, an error is issued to indicate that there is an existing incompatible PDF file and the program exits with a nonzero return code.

PDF optimization must be done at least at the **-O2** optimization level and is recommended at **-O4** and higher.

When you compile your program with **-qpdf1**, the **-qipa=level=0** option is enabled by default. When option **-O4**, **-O5**, or any level of option **-qipa** is in effect, and you specify the **-qpdf1** option at the link step but not at the compile step, the compiler issues a warning message. The message indicates that you must recompile your program to get all the profiling information.

A PDF map file is generated at this step. You can use the **showpdf** command to display part of the profiling information in text or XML format. If you do not need to view the profiling information, specify the **-qnoshowpdf** option at this step so that the PDF map file is not generated.

Example

You can compile the following source files with **-qpdf1** at **-O3**.

```
xlf -qpdf1 -O3 file1.f file2.f file3.f
```

Related information in the *XL Fortran Compiler Reference*

 **-qpdf1**, **-qpdf2**

 **-O**, **-qoptimize**

 **showpdf**

 **-qshowpdf**

Training with typical data sets

Run the resulting application with typical data sets. This step is called the PDF training step.

You can train the resulting application multiple times with different typical data sets. The profiling information is accumulated into PDF files to provide a count of how often branches are taken and blocks of code are run, based on the input data used.

You can get PDF files in the following ways:

- Generate PDF files upon normal termination. For more information, see “Generating PDF files upon normal termination” on page 17.
- Dump snapshot PDF profiling information to files during execution. For more information, see “Dumping snapshot PDF profiling information during execution” on page 17.

Usage

You should use typical data sets for the PDF training step. Otherwise, the analysis of infrequently executed code paths might be distorted.

The PDF file is placed in the current working directory or the directory specified by the PDFDIR environment variable. To override the default file path or name, use the **-qpdf1=pdfname** or **-qpdf1=defname** option. If the PDFDIR environment variable is set but the specified directory does not exist, the compiler issues a warning message. To avoid wasting compile and run time, make sure that the PDFDIR environment variable is set to an absolute path. Otherwise, you might run the application from a wrong directory and the compiler cannot locate the profiling information files. When it happens, the program might not be optimized correctly or might be stopped by a segmentation fault. A segmentation fault might also

happen if you change the value of the PDFDIR environment variable and run the application before the PDF process finishes.

If you have several PDF files, use the **mergepdf** command to combine these PDF files into one PDF file.

If you recompile your program with **-qpdf1**, the compiler removes the existing PDF file or files whose names and locations are the same as the file or files that are to be created in the training step before the compiler generates a new application.

Notes:

- You cannot mix PDF and PDF map files that are generated for different programs. Further, you cannot mix PDF and PDF map files that are generated from multiple compilation processes with different **-qpdf1** settings for the same program.
- You must use the same version and PTF level of the compiler to generate the PDF file and the PDF map file.
- You cannot edit PDF files that are generated by the resulting application. Otherwise, the performance or function of the generated executable application might be affected.

Related information in the *XL Fortran Compiler Reference*

 -qpdf1, -qpdf2

 -O, -qoptimize

 mergepdf

 PDF environment variables

Generating PDF files upon normal termination:

When you run an application that was generated in the PDF1 step and end the application using normal methods, a standard PDF file is generated.

This PDF file is named `.<output_name>.pdf` by default, where `<output_name>` is the name of the output file that was generated in the PDF1 step.

Normal termination methods include reaching the end of the execution for the main function.

Related information

 Profile-directed feedback

 -qpdf1, -qpdf2

 Training with typical data sets

 Dumping snapshot PDF profiling information during execution

Dumping snapshot PDF profiling information during execution:

Before you begin

Compile some or all of the source files in a program with the **-qpdf1** option.

About this task

In addition to getting PDF profiling information that is written to one or more PDF files upon normal termination, you can dump PDF profiling information to one or more PDF snapshot files during execution. This is especially useful when the application is to be terminated abnormally, for example, when you end a process by using SIGKILL or a system call `exit()`, `_Exit()`, or `abort()`.

Procedure

1. Define environment variable `PDF_SIGNAL_TO_DUMP` as a signal value that is an integer in the range of `SIGRTMIN` and `SIGRTMAX` inclusive. This value is read during program initialization.
2. Run the application that was generated in the PDF1 step.
3. Send the user-defined signal value as a trigger to dump PDF profiling information to PDF snapshot files. You can send the user-defined signal value multiple times for each process, and the corresponding PDF snapshot file is overwritten each time. The running application processes continue running until normal termination.

Results

A PDF snapshot file is created for each process with suffix `_snapshot.<pid>`, and it is named `.<output_name>_pdf_snapshot.<pid>` by default, where `<output_name>` is the name of the output file that is generated in the PDF1 step and `<pid>` is the ID of the process.

If the application creates more than one process, equivalent number of PDF data files are generated when each process receives the signal.

If multiple PDF snapshot files are generated, you must merge the PDF snapshot files for multiple processes by using the **mergepdf** command before linking or recompiling the program with **-qpdf2**.

If the application ends normally by executing exit handlers, a standard PDF file named `.<output_name>_pdf` is also generated.

Example

In this example, program `myprogram` has a parent process and a child process. You can dump snapshot PDF profiling information to files during execution and use the merged PDF file to fine-tune the optimizations as follows:

1. Compile `myprogram.f` with **-qpdf1** and name the executable file as `myprogram`.

```
xlf -O2 -qpdf1 -o myprogram myprogram.f
```
2. Define environment variable `PDF_SIGNAL_TO_DUMP` as 52, which is in the range of `SIGRTMIN` and `SIGRTMAX` inclusive.

```
export PDF_SIGNAL_TO_DUMP=52
```
3. Run the compiled application.

```
./myprogram < sample.data &
```

The following process ID is displayed:

```
[138705] ./myprogram &
```

4. Send the user-defined signal 52 to dump PDF profiling information by using the **kill** command.

Note: The `kill` command does not terminate the processes when the signal value is recognized.

```
kill -s 52 138705
```

Because the application creates a parent process and a child process, both processes receive the signal value. The following messages are displayed for both processes:

```
PDFRunTime: Caught user signal "52", dumping PDF data ... Done.  
PDFRunTime: Caught user signal "52", dumping PDF data ... Done.
```

Two PDF snapshot files that are suffixed with process ID, `.myprogram_pdf_snapshot.138705` and `.myprogram_pdf_snapshot.138706`, are created, where 138706 is a child process of 138705.

5. Merge PDF data for the two processes as `.myprogram_pdf`.

```
mergepdf .myprogram_pdf_snapshot.* -o .myprogram_pdf
```

6. Recompile `myprogram.f` by using the same compiler options as step 1, but change `-qpdf1` to `-qpdf2`. `.myprogram_pdf` is used to fine-tune the optimizations.

```
xlf -O2 -qpdf2 -o myprogram myprogram.f
```

Related information in the *XL Fortran Compiler Reference*



`-qpdf1`, `-qpdf2`



`mergepdf`

Recompiling or linking with `-qpdf2`

Recompile or link your program by using the same compiler options as before, but change `-qpdf1` to `-qpdf2`. This step is called the PDF2 step.

If you want to optimize the entire application, you can do the PDF2 step at executable level in the link step and create executable files for your programs. For details, see “Executable level profile-directed feedback” on page 20.

In addition to optimizing entire application, you can do the PDF2 step at object level in the compile time and create object files for your programs. This can be an advantage for applications where patches or updates are distributed as object files or libraries rather than as executables. In this case, you cannot enable interprocedural analysis (IPA) optimizations. For details, see “Object level profile-directed feedback” on page 21.

Usage

The accumulated profiling information is used to fine-tune the optimizations. The resulting program contains no profiling overhead and runs at full speed. You must ensure the PDF file that is fed into the PDF2 step is the one that is generated in the PDF training step. For example, when the `-qpdf1=pdfname=file_path` option is used during the PDF1 step, you must use the same `-qpdf2=pdfname=file_path` option during the PDF2 step for the compiler to recognize the correct PDF file. This rule also applies to the `-qpdf[1|2]=exename` and `-qpdf[1|2]=defname` options.

You are highly recommended to use the same optimization level at all compilation steps for a particular program. Otherwise, the PDF process cannot optimize your program correctly and might even slow it down. All compiler settings that affect optimization must be the same, including any supplied by configuration files.

You can modify your source code and use the **-qpdf1** and **-qpdf2** options to compile your program. Old profiling information can still be preserved and used during the second stage of the PDF process. The compiler issues a list of warnings but the compilation does not stop. An information message is also issued with a number in the range of 0 - 100 to indicate how outdated the old profiling information is. If you have not changed your program between the **-qpdf1** and **-qpdf2** phases, the number is 100, which means that all the profiling information can be used to optimize the program. If the number is 0, it means that the profiling information is completely outdated, and the compiler cannot take advantage of any information. When the number is less than 100, you can choose to recompile your program with the **-qpdf1** option and regenerate the profiling information.

If the compiler cannot read any PDF files in this step, the compiler issues error message 1586-401 but continues the compilation. If you want the compiler to stop the compilation, specify **-qhaltonmsg=1586-401**.

If you want to erase the PDF information, use the **cleanpdf** command.

Related information in the *XL Fortran Compiler Reference*



Profile-directed feedback



-qpdf1, **-qpdf2**



-O, **-qoptimize**



-qreport



cleanpdf

Executable level profile-directed feedback:

About this task

When you compile your program with **-qpdf2**, the **-qipa=level=0** option is enabled by default, so IPA and PDF optimization is done in the link step.

It is recommended that you use the **-qpdf2** option to link the object files that are created during the PDF1 step without recompiling your program. Using this approach, you can save considerable compilation time and achieve the same optimization result as if you had recompiled your program during the PDF2 step.

When option **-O4**, **-O5**, or any level of option **-qipa** is in effect, and you specify the **-qpdf1** or **-qpdf2** option at the link step but not at the compile step, the compiler issues a warning message. The message indicates that you must recompile your program to get all the profiling information.

Examples

1. Set the PDFDIR environment variable

```
export PDFDIR=$HOME/project_dir
```
2. Compile most of the files with **-qpdf1**

```
xlf -qpdf1 -O3 -c file1.f file2.f file3.f
```
3. Compile the file that does not need optimization without **-qpdf1**

```
xlf -c file4.f
```
4. Link the PDF object files (file1.o, file2.o, and file3.o) with the non-PDF object file (file4.o)

```
xlf -qpdf1 -O3 file1.o file2.o file3.o file4.o
```

5. Run the resulting application several times with different input data

```
./a.out < polar_orbit.data
./a.out < elliptical_orbit.data
./a.out < geosynchronous_orbit.data
```
6. Link all the object files into the final application with **-qpdf2**.







```
xlf -qpdf2 -O3 file1.o file2.o file3.o file4.o
```

Instead of step 6 in this example, you can recompile your program with **-qpdf2**.

```
xlf -qpdf2 -O3 file1.f file2.f file3.f file4.f
```

Both recompiling and linking your program with **-qpdf2** can use the accumulated profiling information to fine-tune the optimizations.

Related information

-  Profile-directed feedback
-  -qpdf1, -qpdf2
-  Recompiling or linking with -qpdf2
-  Object level profile-directed feedback
-  -O, -qoptimize
-  -qipa

Object level profile-directed feedback: About this task

In addition to optimizing entire executables, profile-directed feedback (PDF) can also be applied to specific object files. This approach can be an advantage in applications where patches or updates are distributed as object files or libraries rather than as executables. Also, specific areas of functionality in your application can be optimized without the process of relinking the entire application. In large applications, you can save the time and trouble that otherwise need to be spent relinking the application.

The process for using object level PDF is essentially the same as the executable level PDF process but with a small change to the PDF2 step. For object level PDF, compile your program by using the **-qpdf1** option, run the resulting application with representative data, compile the program again with the **-qpdf2** option. You need to specify **-qnoipa** with **-qpdf2**, which means you cannot use interprocedural analysis (IPA) optimizations and object level PDF at the same time.

If you specify **-qpdf2 -qnoipa**, object level PDF optimization is done in the compile step. You must take either one of the following actions to ensure that the compiler can recognize the correct PDF file:

- In the PDF1 step, specify **-qpdf1=defname** to revert the PDF file name to `._pdf`. Thus, the compiler looks for `._pdf` in the PDF2 step.
- In the PDF2 step, specify **-qpdf2=pdfname=file_path**, where *file_path* is the path and name of the generated PDF file.

The following steps outline this process:

1. Compile your program by using the **-qpdf1** option. For example:

```
xlf -c -O3 -qpdf1 file1.f file2.f file3.f
```

In this example, the optimization level **-O3** is used, which is a moderate level of optimization.

2. Link the object files to get an instrumented executable:

```
xlf -O3 -qpdf1 file1.o file2.o file3.o
```

3. Run the instrumented executable with sample data that is representative of the data you want to optimize for.

```
a.out < sample_data
```

4. Compile the program again by using the **-qpdf2** option. Specify the **-qnoipa** option so that the linking step is skipped and PDF optimization is applied to the object files rather than to the entire executable.

```
xlf -c -O3 -qpdf2 -qnoipa file1.f file2.f file3.f
```

The resulting output of this step are object files optimized for the sample data processed by the original instrumented executable. In this example, the optimized object files would be file1.o, file2.o, and file3.o. These object files can be linked by using the system loader **ld** or by omitting the **-c** option in the PDF2 step.

Related information



Profile-directed feedback



-qpdf1, -qpdf2



Recompiling or linking with -qpdf2



Executable level profile-directed feedback



-O, -qoptimize



-qipa

Vector technology

Vector technology is a PowerPC technology for accelerating the performance-driven, high-bandwidth communications and computing applications. You can use the vector technology to get dramatic performance improvement for your applications.

There are two ways of using the vector technology: hand coding and automatic vectorization. Automatic vectorization often brings the best performance when you write the code in the right way, but appropriate hand coding can provide additional performance improvement.

The following example shows the difference between a simple array element addition and a vectorized version of the same loop.

Array element addition without using the vector technology:

```
subroutine myadd(n)
  integer :: i, n
  real(4), dimension(n) :: a, b, c

  do i=1, n
    a(i) = b(i) + c(i)
  enddo
end subroutine
```

Modified array element addition utilizing the vector technology:

```

subroutine myadd_vector(n)
  integer :: j, n
! vector_size is a constant; for real(4) it must be 16/4 = 4
! n must be a multiple of vector_size
  vector(real(4)), dimension(n/vector_size) :: v_a, v_b, v_c

  do j=1, n/vector_size
    v_a(j) = vec_add(v_b(j), v_c(j))
  enddo
end subroutine

```

In the vectorized version of the code, the data type is replaced by the vector data type. The loop range is reduced from n to $n/\text{vector_size}$. With the vector technology, the operation, $v_a(j)=\text{vec_add}(v_b(j), v_c(j))$, is executed in a single machine instruction for each vector. Without the vector technology, the same operation requires multiple instructions costing several processor clock cycles. Therefore, the vector technology can improve the performance of an application.

This section provides general information about vector technology with the following three subsections:

- “Vector technology information”
- “Explicitly calling vector libraries for vectorization” on page 24
- “Auto-vectorization limitations” on page 25

Vector technology information

This section provides links to all of the information about the vector technology and categorize them into the following types:

- Using vector technology with hand coding
- Using vector technology with auto-vectorization

Using vector technology with hand coding

The following table lists the information about using the vector technology with hand coding and provides the links to the detailed information in different documents.

Table 8. Language features for using vector technology with hand coding:

Information you need	Sections you can read
Intrinsic data types	Vector (IBM extension) in <i>XL Fortran Language Reference</i>
Vector type declaration statement	Vector (IBM extension) in <i>XL Fortran Language Reference</i>
Vector intrinsic procedures	Vector intrinsic procedures (IBM extension) in <i>XL Fortran Language Reference</i>
Using the vector libraries	Using the vector libraries

Using vector technology with auto-vectorization

The following table lists the information about compiler options for auto-vectorization and provides the links to the detailed information in different documents.

Table 9. Information about compiler options for auto-vectorization

To do...	Read...
Enable automatic generation of vector instructions for processors that support them.	-qsimd in <i>XL Fortran Compiler Reference</i>
Perform high-order transformations (HOT) during optimization.	-qhot in <i>XL Fortran Compiler Reference</i>
Produce listing files and understand how sections of code have been optimized.	<ul style="list-style-type: none"> • -qlistfmt in <i>XL Fortran Compiler Reference</i> • -qreport in <i>XL Fortran Compiler Reference</i> • Using compiler reports to diagnose optimization opportunities • Parsing compiler reports with development tools
Ensure that optimizations done by default, do not alter certain program semantics related to strict IEEE floating-point conformance.	-qstrict in <i>XL Fortran Compiler Reference</i>
Tuning for your target architecture using -qarch and -qtune.	<ul style="list-style-type: none"> • Tuning for your target architecture • Using -qtune

The following table lists the directive and compiler option that you can use to prohibit auto-vectorization and provides the links to the detailed information in different documents.

Table 10. Directive and compiler option for auto-vectorization

To do...	Read...
Prohibit the compiler from auto-vectorizing the loop immediately following the directive.	NOVECTOR in <i>XL Fortran Language Reference</i>
Disable auto-vectorization.	-qsimd in <i>XL Fortran Compiler Reference</i>

Some optimization processes are related to auto-vectorization, you can use compiler options to control these optimizations. The following table lists these optimization processes and provides the links to the detailed information in different documents.

Table 11. Optimizations related to auto-vectorization

To learn about...	Read...
The High-order transformation (HOT)	<ul style="list-style-type: none"> • High-order transformation (HOT) • An intermediate step: adding -qhot suboptions at level 3
The Interprocedural analysis (IPA)	The IPA process

Explicitly calling vector libraries for vectorization

To use the vector technology in your applications, you can either rewrite the algorithm manually or rely on the automatic vectorization of the compiler. Although automatic vectorization can provide the highest performing solution, proper hand coding can also bring good performance.

The following example shows how to explicitly call the vector libraries to make use of the vector functionality provided by the target hardware.

```

function dotp(x,y,n) result(s)
    real*8 x(*),y(*),s
    vector(real(8)) sv,xv,yv
    integer i,n

    sv = vec_splats(0.000)
    do i=1,n,2
        xv = vec_xld2(0,x(i))
        yv = vec_xld2(0,y(i))
        sv = vec_madd(xv,yv,sv)
    enddo
    s = vec_extract(sv,0)+vec_extract(sv,1)
    if (mod(n,2) .eq. 1) then
        s = s + x(n)*y(n)
    endif
end function

program dot
    real*8 x(100),y(100),s
    integer i
    do i=1,100
        x(i)=0.5*i
        y(i)=2.0
    enddo
    s = dotp(x,y,100)
    print *,s
end

```

The program performs the dot product for two arrays of REAL. At each iteration, two elements from the arrays are loaded into two REAL vector variables. The program then uses a multiply add operation to calculate the product of the two vectors and add the product with the previous sum. At the end of the loop the two elements of the vector that hold the partial sums are added to form the complete sum value. If the size of the input vectors do not evenly fit in the vector variables, a single scalar product is performed to complete the dot product computation.

Auto-vectorization limitations

When you use the auto-vectorization, you might find that some transformations cannot be performed. If you compile with **-qhot** and **-qlistfmt=xml=transforms** or **-qlistfmt=xml=all**, you can get a compiler report that lists the reasons why some transformations were not performed. For detailed information about the possible reasons, see [Using compiler reports to diagnose optimization opportunities](#).

This section uses two code examples to illustrate why auto-vectorization cannot be performed under certain situations.

Example 1:

```

program try
    real*8 x(100)
    integer i
    x(1)=9
    do i=2,100
        x(i)=x(i-1)
    enddo
end

```

The $x(i)=x(i-1)$ statement violates the restriction that "a loop cannot be automatically parallelized if one of its variables carries a dependency". $x(i)$ and $x(i-1)$ depend on each other in this sample, which makes the loop non-vectorizable.

Example 2:

```
program try
  real*8 x(100)
  integer i
  do i=1,100,5
    x(i)=i + 8;
    x(i+1)=i + 9;
    x(i+2)=i + 12;
    x(i+3)=i + 15;
  enddo
end
```

The following statements violate the restriction that auto-vectorization cannot be performed if the loop contains a non stride one store.

```
x(i)=i + 8;
x(i+1)=i + 9;
x(i+2)=i + 12;
x(i+3)=i + 15;
```

In each iteration of the loop, four elements in the array x are accessed and one element is skipped. This continues until the end of the loop, which makes the loop non-vectorizable.

Using compiler reports to diagnose optimization opportunities

You can use the `-qlistfmt` option to generate a compiler report in XML or HTML format. It provides information about how your program is optimized. You can also use the `genhtml` utility to convert an existing XML report to HTML format. This information helps you understand your application codes and tune codes for better performance.

The compiler report in XML format can be viewed in a browser that supports XSLT. If you compile with the `stylesheet` suboption, for example, `-qlistfmt=xml=all:stylesheet=xstyle.xsl`, the report contains a link to a stylesheet that renders the XML readable. By reading the report, you can detect opportunities to further optimize your code. You can also create tools to parse this information.

By default, the name of the report is `a.xml` for XML format, and `a.html` for HTML format. You can use the `-qlistfmt=xml=filename` or `-qlistfmt=html=filename` option to override the default name.

Inline reports

If you compile with `-qinline` and one of `-qlistfmt=xml=inlines`, `-qlistfmt=html=inlines`, `-qlistfmt=xml`, or `-qlistfmt=html`, the generated compiler report includes a list of inline attempts during compilation. The report also specifies the type of attempt and its outcome.

For each function that the compiler has attempted to inline, there is an indication of whether the inline was successful. The report might contain any number of reasons why a named function has not been successfully inlined. Some examples of these reasons are as follows:

- `FunctionTooBig` - The function is too big to be inlined.

- RecursiveCall - The function is not inlined because it is recursive.
- ProhibitedByUser - Inlining was not performed because of a user-specified pragma or directive.
- CallerIsNoopt - No inlining was performed because the caller was compiled without optimization.
- WeakAndNotExplicitlyInline - The calling function is weak and not marked as inline.

For a complete list of the possible reasons, see the Inline optimization types section of the XML schema help file named XMLContent.html in the /opt/ibm/xlf/15.1.4/listings/ directory. The Japanese and Chinese versions of the help file, XMLContent-Japanese.utf8.html and XMLContent-Chinese.utf8.html, are included in this directory as well.

Loop transformations

If you compile with **-qhot** and one of **-qlistfmt=xml=transforms**, **-qlistfmt=html=transforms**, **-qlistfmt=xml** or **-qlistfmt=html**, the generated compiler report includes a list of the transformations performed on all loops in the file during compilation. The report also lists the reasons why transformations were not performed in some cases:

- Reasons why a loop cannot be automatically parallelized
- Reasons why a loop cannot be unrolled
- Reasons why SIMD vectorization failed

For a complete list of the possible transformation problems, see the Loop transformation types section of the XML schema help file named XMLContent.html in the /opt/ibm/xlf/15.1.4/listings/ directory.

Data reorganizations

If you compile with **-qhot** and one of **-qlistfmt=xml=data**, **-qlistfmt=html=data**, **-qlistfmt=xml**, or **-qlistfmt=html**, the generated compiler report includes a list of data reorganizations performed on the program during compilation. Here are some examples of data reorganizations:

- Array splitting
- Array coalescing
- Array interleaving
- Array transposition
- Common block splitting
- Memory merge

For each of these reorganizations, the report contains details about the name of the data, file names, line numbers, and the region names.

Profile-directed feedback reports

If you compile with **-qpdf2** and one of **-qlistfmt=xml=pdf**, **-qlistfmt=html=pdf**, **-qlistfmt=xml**, or **-qlistfmt=html**, the generated compiler report includes the following information:

- Loop iteration counts
- Block and call counts

- Cache misses (if compiled with `-qpdf1=level=2`)

Related information:

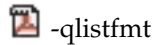

Parsing compiler reports with development tools

You can write tools to parse the compiler reports produced in XML format to help you find opportunities to improve application performance.

The compiler includes an XML schema that you can use to create a tool to parse the compiler reports and display aspects of your code that might represent performance improvement opportunities. The schema, `xllisting.xsd`, is located in the `/opt/ibm/xlf/15.1.4/listings/` directory. This schema helps present the information from the report in a tree structure.

You can also find a schema help file named `XMLContent.html` that helps you understand the schema details. The Japanese and Chinese versions of the help file, `XMLContent-Japanese.utf8.html` and `XMLContent-Chinese.utf8.html`, are in the same directory.

Tracing procedures in your code

You can instruct the compiler to insert calls to the tracing procedures that you have defined to aid in debugging or timing the execution of other procedures.

To trace procedures in your program, you must specify which procedures to trace. You must also provide your own tracing procedures. If you enable tracing without providing tracing procedures, you will get linker errors about undefined symbols called `__func_trace_enter`, `__func_trace_exit`, and possibly `__func_trace_catch`.

Specifying which procedures to trace

The `-qfunctrace` compiler option controls tracing for all non-inlined user-defined procedures and all outlined compiler-generated procedures in your program. If you are interested in tracing specific external or module procedures, you can use the `-qfunctrace+` and `-qfunctrace-` compiler options. You can also specify the `NOFUNCTRACE` directive to disable the tracing of entire modules, external procedures, module procedures, or internal procedures.

What can be traced

Tracing applies to programs, external procedures, non-intrinsic module procedures, and internal procedures.

Compiler-generated procedures are not traced unless they were generated for outlined user code, such as an OpenMP program. In those cases, the name of the outlined procedure contains the name of the original user procedure as a prefix.

Inlined procedures and statement functions cannot be traced because they do not exist in the executable.

To avoid infinite recursion, user-defined tracing procedures cannot be traced. Similarly, tracing must be disabled for procedures called from user-defined tracing procedures.

How to write tracing procedures

You can implement the tracing procedures in Fortran, C, or C++.

To implement the tracing procedures in Fortran, the characteristics of the procedures must be the same as those specified in the following interface:

```
SUBROUTINE routine_name(procedure_name, file_name, line_number, id)
  USE, INTRINSIC :: iso_c_binding
  CHARACTER(*), INTENT(IN) :: procedure_name
  CHARACTER(*), INTENT(IN) :: file_name
  INTEGER(C_INT), INTENT(IN) :: line_number
  TYPE(C_PTR), INTENT(INOUT) :: id
END SUBROUTINE
```

where `routine_name` is the name of an external or module procedure.

You must then tell the compiler to use your subroutine as a tracing procedure in one of the following ways:

- Using the `-qfunctrace_xlf_enter`, `-qfunctrace_xlf_exit`, or `-qfunctrace_xlf_catch` compiler options.
- Using the `FUNCTTRACE_XLF_ENTER`, `FUNCTTRACE_XLF_EXIT`, or `FUNCTTRACE_XLF_CATCH` directives.

When you specify these options or directives, XL Fortran generates wrapper procedures called `__func_trace_enter`, `__func_trace_exit`, and `__func_trace_catch` that call your corresponding tracing procedure. These wrappers allow interoperability with C and C++ by converting the dummy arguments from the C prototype to the interface described earlier. `routine_name` must therefore not be named `__func_trace_enter`, `__func_trace_exit`, or `__func_trace_catch`. In addition, your program must not contain more than one of each of the tracing procedures.

Writing the tracing procedures in C or C++ requires that you provide the `__func_trace_enter`, `__func_trace_exit`, and `__func_trace_catch` procedures directly. They must have the following prototypes:

- `void __func_trace_enter(const char *const procedure_name, const char *const file_name, int line_number, void **const id);`
- `void __func_trace_exit(const char *const procedure_name, const char *const file_name, int line_number, void **const id);`
- `void __func_trace_catch(const char *const procedure_name, const char *const file_name, int line_number, void **const id);`

Note: If you write the tracing procedures in C++, they must be declared extern "C".

XL Fortran inserts calls to your tracing procedures on procedure entry and exit. It passes the name of the procedure being traced, the name of the file containing the entry or exit point being traced, and the line number. It also passes the address of a static pointer that is initialized to `C_NULL_PTR` at the beginning of the program. This pointer allows you to store arbitrary data in the entry tracing procedure and access this data in the exit and catch procedures. See the Examples section for detail. Because this pointer resides in static memory, extra steps might be needed when tracing threaded or recursive procedures.

Sample tracing procedures

XL Fortran provides sample tracing procedures in the `/opt/ibm/xlf/15.1.0/samples/functrace` directory. You can use these procedures for simple tracing, or you can modify them for more complex tracing.

- `tracing_routines.c`: Provides tracing procedures written in C. This file is useful when you do not require access to Fortran modules, and when there is a possibility of recursive input / output.
- `tracing_routines.f90`: Provides tracing procedures written in Fortran. This file is useful when you need access to Fortran modules or intrinsics in your tracing procedures.

The following example illustrates the use of the samples for simple tracing:

```
> cat helloworld.f
print *, 'hello world'
end
> cc -c /opt/ibm/xlf/15.1.0/samples/functrace/tracing_routines.c
> xlf95 helloworld.f -qfunctrace tracing_routines.o
** _main   === End of Compilation 1 ===
1501-510  Compilation successful for file helloworld.f.
> ./a.out
{ _main (helloworld.f:1)
  hello world
} _main (helloworld.f:2)

>
```

Tracing limitations

The procedure tracing functionality has the following limitations:

- A procedure cannot be traced separately from its **ENTRY** points. Either all are traced or none are. The name of the procedure is passed to the tracing procedure even when tracing the **ENTRY** point. The line number helps distinguish what is being traced in this case.
- The Fortran standard requires pure procedures to have no side effects. The compiler uses this assumption when optimizing your program. If you enable tracing of a pure procedure, your tracing procedure must not change the program state in a way that creates a side effect.
- The Fortran standard imposes limits on recursive input/output. If you write your tracing procedures in Fortran, you must be careful not to break these rules.

The following example has a print statement where an I/O item is the result of a function call (`foo`). It is illegal for the tracing procedure in this case to have I/O on an external file:

```
> cat recursive.f
integer function test()
  test = 1
end function

integer test
print *, test() ! test must not have I/O on external unit
end
> xlf95 -c /opt/ibm/xlf/15.1.0/samples/functrace/tracing_routines.f90
** my_func_trace_enter   === End of Compilation 1 ===
** my_func_trace_exit    === End of Compilation 2 ===
** my_func_trace_catch   === End of Compilation 3 ===
1501-510  Compilation successful for file tracing_routines.f90.
> xlf95 recursive.f tracing_routines.o -qfunctrace
** test   === End of Compilation 1 ===
** _main  === End of Compilation 2 ===
```

```

1501-510 Compilation successful for file recursive.f.
> ./a.out
{ _main (recursive.f:6)
XL Fortran (I/O initialization): I/O recursion detected.
Aborted
>

```

Note: You can work around this by writing the tracing procedure in C. For an example, see the `tracing_routines.c` sample file described in section “Sample tracing procedures” on page 30.

- When optimizing your program, the compiler reorders code and removes dead code. As a result, the line number passed to the tracing procedure might not be accurate when optimization is enabled.

Examples

In the following example, `-qfunctrace` is used to measure the time spent in each external procedure. The `FUNCTRACE_XLF_ENTER` and `FUNCTRACE_XLF_EXIT` directives are used to specify procedures `my_enter` and `my_exit` as the tracing procedures. The `NOFUNCTRACE` directive is used to disable tracing of `main_program`:

```

> cat example.f
! Designate my_enter as a tracing procedure that should be called
! on procedure entry
!ibm* functrace_xlf_enter
subroutine my_enter(procedure_name, file_name, line_number, id)
  use, intrinsic :: iso_c_binding
  use, intrinsic :: xlfutility
  character(*), intent(in) :: procedure_name, file_name
  integer(c_int), intent(in) :: line_number
  type(c_ptr), intent(inout) :: id

  integer(kind=time_size), pointer :: enter_count

  ! Store the time we entered the procedure being traced into id.
  if (.not. c_associated(id)) then
    allocate(enter_count)
    enter_count = time_()
    id = c_loc(enter_count)
  end if

  print *, 'Entered procedure ', procedure_name, ' at ( ', &
          file_name, ' :', line_number, ').'
end subroutine

! Designate my_exit as a tracing procedure that should be called
! on procedure exit
!ibm* functrace_xlf_exit
subroutine my_exit(procedure_name, file_name, line_number, id)
  use, intrinsic :: iso_c_binding
  use, intrinsic :: xlfutility
  character(*), intent(in) :: procedure_name, file_name
  integer(c_int), intent(in) :: line_number
  type(c_ptr), intent(inout) :: id

  integer(kind=time_size), pointer :: enter_count
  integer(kind=time_size) exit_count, duration

  ! id should have been associated in my_enter with the time we
  ! entered the procedure being traced. Find the elapsed time.
  if (c_associated(id)) then
    exit_count = time_()
    call c_f_pointer(id, enter_count)

```

```

        duration = exit_count - enter_count
    else
        stop "error!"
    endif

    print *, 'Leaving procedure ', procedure_name, ' at ( ', &
           file_name, ' : ', line_number, ').'
    print *, 'Spent', duration, 'seconds in ', procedure_name, '.'
end subroutine

! sub2 will be traced
subroutine sub2
    call sleep_(3)
end subroutine

! sub1 will be traced
subroutine sub1
    call sleep_(5)
    call sub2
end subroutine

! Do not want to trace main_program
!ibm* nofunctrace
program main_program
    call sub1
end program
> xlf95 example.f -qfunctrace
** my_enter   === End of Compilation 1 ===
** my_exit   === End of Compilation 2 ===
** sub2      === End of Compilation 3 ===
** sub1      === End of Compilation 4 ===
** main_program === End of Compilation 5 ===
1501-510 Compilation successful for file example.f.
> ./a.out
Entered procedure sub1 at ( example.f : 59 ).
Entered procedure sub2 at ( example.f : 54 ).
Leaving procedure sub2 at ( example.f : 55 ).
Spent 3 seconds in sub2.
Leaving procedure sub1 at ( example.f : 61 ).
Spent 8 seconds in sub1.
>

```

Related information

- For details about the **-qfunctrace** compiler option, see **-qfunctrace** in the *XL Fortran Compiler Reference*.
- For details about **-qfunctrace_xlf_catch**, **-qfunctrace_xlf_enter**, or **-qfunctrace_xlf_exit** compiler options, see the Detailed descriptions of the XL Fortran compiler options section in the *XL Fortran Compiler Reference*.
- For details about the **FUNCTRACE_XLF_CATCH**, **FUNCTRACE_XLF_ENTER**, and **FUNCTRACE_XLF_EXIT** directives, see Detailed directive descriptions section in the *XL Fortran Language Reference*.
- For details about the **NOFUNCTRACE** directive, see **NOFUNCTRACE** in the *XL Fortran Language Reference*.

Getting more performance

The XL compiler family offers other strategies and tuning alternatives for increasing performance.

Whether you are already optimizing at **-O5**, or you are looking for more opportunities to increase performance without the resource costs of optimizing at higher levels, the XL compiler family offers other strategies and tuning alternatives. For more information, see the following topics:

- Tuning XL compiler applications
- Advanced optimization concepts
- Optimizing your SMP code

Beyond performance: effective programming techniques

Applications that perform well begin with applications that are written well. See the following topics for information about writing better code; whether your goal is to make your code more portable, more easily optimized, or interoperable with other languages.

- Chapter 4, “Managing code size,” on page 47
- Chapter 6, “Compiler-friendly programming techniques,” on page 57
- Chapter 8, “Parallel programming with XL Fortran,” on page 79
- Chapter 9, “Interlanguage calls,” on page 259

Chapter 2. Tuning XL compiler applications

Included as part of the XL Fortran optimization suite are options you can use to instruct the compiler to generate code that executes optimally on a given processor or architecture family, and to instruct the compiler on the execution characteristics of your application.

The better you can convey those characteristics, the more precisely the compiler can tune and optimize your application. This section assumes that you have already begun optimizing your application using the strategies found in *Optimizing your applications*.

Tuning for your target architecture

By default, the compiler generates code that runs on all supported systems, though this code does not run optimally on all supported systems. By selecting options to target the appropriate architectures, you can optimize your application to suit the broadest possible selection of relevant processors, a range of processors within a given family, or a specific processor.

The compiler options in the *Options for targeting your architecture* table introduce how you can control optimizations affecting individual aspects of your target architecture. This section also goes into further detail on how you can use some of those options to ensure your application provides the best possible performance on those targets.

Table 12. Options for targeting your architecture

Option	Behavior
-qarch	Selects a family of processor architectures, or a specific architecture that the compiler will generate machine instructions for. If you specify multiple architecture settings, only the last architecture is considered valid.
-qtune	Focuses optimizations for execution on a given processor without restricting the processor architectures that your application can execute on. If you specify multiple architecture settings, only the last architecture is considered valid. You can also use -qtune to specify the processor SMT level that the program will execute on.
-qcache	Defines a specific cache or memory geometry. Selecting a predefined optimization level like -O2 sets default values for -qcache suboptions.

In addition to targeting the correct architecture for your application, it is important to select the right level of optimization. Combining the appropriate architecture settings with an optimization level that fits your application can vastly enhance performance. If you have not already done so, consult *Optimizing your applications* in addition to this section.

Using **-qarch**

Using **-qarch** you can select a machine architecture or a family of architectures on which you can run your application. Selecting the correct **-qarch** suboption is crucial to influencing chip-level optimization as the choice of **-qarch** suboption controls:

- The list of machine instructions available to the compiler when generating object code.
- The characteristics and capabilities of the hardware the compiler will model when optimizing.
- Optimization trade-offs and opportunities in individual instruction selection and instruction sequence selection
- The default setting of the **-qtune** option.

Architecture selection is important at all optimization levels. Even at low optimization levels like **-O0** and **-O2**, specifying the correct target architecture can be beneficial to performance. Specifying the correct target allows the compiler to select more efficient machine instructions and generate instruction sequences that perform best for a particular machine.

The **-qarch** suboptions allow you to specify individual processors or a family of processors with common instruction sets or subsets. The choice of processor gives you the flexibility of compiling your application to execute optimally on a particular machine, or to execute on a wide variety of machines while still applying as much architecture-specific optimization as possible. The less specific your choice of architecture, the fewer machine instructions available to the compiler when generating code. A less specific choice can also limit the number of hardware intrinsic functions available to your application. A more specific choice of architecture, can make available more instructions and hardware intrinsic functions. The *XL Fortran Compiler Reference* details the specific chip architectures and architecture families available.

When compiling your application, using a consistent or compatible **-qarch** setting for all files will ensure that you are getting the most from your architecture targets. If you are using **-qipa** link-time optimizations, the architecture setting you specify on the link step overrides the compile step setting.

You must ensure that your application executes only on machines that support your **-qarch** settings. Executing your application on other machines can produce incorrect results, even if your application appears to run without trapping.

Using **-qtune**

The **-qtune** option focuses optimizations for execution on a given processor without restricting the processor architectures that your application can execute on, generating machine instructions consistent with your **-qarch** architecture choice. Using **-qtune** also guides the optimizer in performing transformations, such as instruction scheduling, so that the resulting code executes most efficiently on your chosen **-qtune** architecture. The **-qtune** option tunes code to run on one particular processor architecture, and includes only specific processors as suboptions. The **-qtune** option does not support suboptions representing families of processors.

Use **-qtune** to specify the most common or critical processor where your application executes.

If you need to create a single binary file that runs on a range of PowerPC hardware, consider using the **-qtune=balanced** option. With this option in effect, optimization decisions made by the compiler are not targeted to a specific version of hardware. Instead, tuning decisions try to include features that are generally helpful across a broad range of hardware and avoid those optimizations that may be harmful on some hardware. Note that you should verify the performance of code compiled with the **-qtune=balanced** option before distributing it.

You can also use **-qtune** to specify the processor SMT level that the program will execute on.

You can also use **-qtune** to specify the processor SMT level that the program will execute on.

Using **-qcache**

The **-qcache** option allows you to instruct the optimizer on the memory cache layout of your target architecture. There are several suboptions you can specify to describe cache characteristics such as:

- The types of cache available
- The cache size
- Cache-miss penalties

The **-qcache** option is only effective if you understand the cache characteristics of the execution environment of your application. Before using **-qcache**, look at the options section of the listing file with the **-qlist** option to see if the current cache settings are acceptable. The settings appear in the listing when you compile with **-qlistopt**. If you are unsure about how to interpret this information, do not use **-qcache**, and allow the compiler to use default cache settings.

If you do not specify **-qcache**, the compiler makes cache assumptions based on your **-qarch** and **-qtune** settings. If you compile with the **-qcache=auto** suboption, the default at optimization levels **-O4** and **-O5**, the compiler detects the cache characteristics of your compilation machine and tunes cache optimizations for that cache layout. If you do specify **-qcache**, also specify **-qhot**, or an option such as **-O4** that implies **-qhot**. The optimizations that **-qhot** performs are designed to take advantage of your **-qcache** settings.

Before you finish tuning

Consult the following list to ensure that you are getting the most out of your target machine options.

- Do not specify a **-qarch** option that is incompatible with your hardware. This can produce unexpected results.
- Specify a **-qarch** setting that represents the largest common instruction set available to the machines that your application will execute on.
- If you are executing your application on multiple machines, choose the **-qtune** suboption that aligns with the machine you expect your application to run on most frequently or where performance is most important.
- If compiling with **-qcache**, specify **-qhot** as well, which can take advantage of your cache settings.

Further option driven tuning

You can use options to convey the characteristics of your application to the compiler, tuning the optimizations that the compiler will apply. Option driven tuning is a process that can require experimentation to find the right combination of options to increase the performance of your application.

The XL compilers support many options that allow you to assert that your application will not follow certain standard language rules in some instances. The compiler assumes language standard compliance and can perform unsafe optimizations if your application is not compliant. Standards-conforming

applications are more easily optimized and more portable, but when full compliance is not possible, use the appropriate options to ensure your code is optimized safely.

For complete compiler option syntax, see the *XL Fortran Compiler Reference*.

Options for providing application characteristics

This section provides a list of options that can dictate a wide variety of characteristics about your application to the compiler including floating-point and loop behaviors.

Option Description

-qalias

Supports several suboptions that can help the compiler analyze the characteristics of your application. For more information on aliasing, see Advanced optimization concepts.

noaryovrlp

Asserts that your application contains no array assignments between storage associated (overlapping) arrays.

nointptr

Asserts that your application does not make use of integer (Cray) pointers.

nopteovrlp

Asserts that your application does not contain pointee variables that refer to any data objects that are not pointee variables. Also, that your application does not contain two pointee variables that can refer to the same storage location.

std

Asserts that your application follows all language rules for variable aliasing. This is the default compiler setting. Specify **-qalias=nostd** if your application does not follow all variable aliasing rules.

-qassert

Includes the following suboptions that can be useful for providing some loop characteristics of your application.

nodeps

Asserts that the loops in your application do not contain loop carried dependencies.

itercnt=*number*

Gives the optimizer a value to use when estimating the number of iterations for loops where it cannot determine that value.

-qddim

Forces the compiler to reevaluate the bounds of a pointee array each time the application references the array. Specify this option only if your application performs dynamic dimensioning of pointee arrays.

-qdirectstorage

Asserts that your application accesses write-through-enabled or cache-inhibited storage.

-qfloat

Provides the compiler with floating-point characteristics for your application. The following suboptions are particularly useful.

nans Asserts that your application makes use of signaling NaN

(not-a-number) floating-point values. Normal floating-point operations do not create these values, your application must create signalling NaNs.

rrm Prohibits optimization transformations that assume the floating-point rounding mode must be the default setting round-to-nearest. If your application changes the rounding mode in any way, specify this option.

-qflttrap

Controls various aspects of floating-point exception handling that your application can require if it attempts to detect or handle such exceptions. If your application enables floating point trapping without using **-qflttrap**, you must use the **-qfloat=fenv** option.

-qiee Specifies the floating-point rounding mode when evaluating expressions at compile time. This option is important if your application requires a non-default rounding mode in order to have consistency between compile-time evaluation and runtime evaluation.

You can also specify **-y** to set the compile-time floating-point rounding mode.

-qlibansi

Asserts that any external function calls in your compilation that have the same name as standard C library function calls, such as malloc or memcpy, are in fact those functions and are not a user-written function with that name.

-qlibmpi

Asserts that all functions with Message Passing Interface (MPI) names are in fact MPI functions and not a user function with different semantics.

-qonetrip

Asserts that all DO loops in your application will execute at least one iteration. You can also specify this behavior with **-1**.

-qnostrictieemod

Relaxes certain rules required by the Fortran 2003 standard related to the use of the IEEE intrinsic modules. Specify this option if your application does not use these modules.

-qstrict_induction

Prevents optimization transformations that would be unsafe if DO loop integer iteration count variables overflow and become negative. Few applications contain algorithms that require this option.

-qthreaded

Informs the compiler that your application will execute in a multithreaded/SMP environment. Using an **_r** invocation, like **xlf_r**, adds this option automatically.

-qnounwind

Informs the compiler that the stack will not be unwound while any routine in your application is active. The **-qnounwind** option enables prologue tailoring optimization, which reduces the number of saves and restores of nonvolatile registers.

-qnozerosize

Asserts that this application does not require checking for zero-sized arrays when performing array operations.

Options to control optimization transformations

There are many options available to you in addition to the base set found in the Optimizing your applications section. Some of these options prevent an optimization that can be unsafe for certain applications or enable one that is safe for your application, but is not normally available as part of the optimization process.

Option Description

-qcompact

Chooses a reduction of final code size over a reduction in execution time. You can use this option to constrain the optimizations of **-O2** and higher. For more information on restriction code size, see the Managing code size section.

-qfdpr Prepares your object code for additional optimization by the FDPR[®] object code optimizer.

-qsimd=auto

Makes use of the vector capabilities of processors.

-qfloat

This option provides a number of suboptions for controlling the optimizations to your floating-point calculations.

norsqrt

Prevents the replacement of the division of the result of a square-root calculation with a multiplication by the reciprocal of the square root.

nostrictmaf

Prevents certain floating-point multiply-and-add instructions where the sign of signed zero value would not be preserved and rounding is in the wrong direction.

-qipa Includes many suboptions that can assist the IPA optimizations while analyzing your application. If you are using the **-qipa** option or higher optimization levels that imply IPA, it is to your benefit to examine the suboptions available.

-qmaxmem

Limits the memory available to certain memory-intensive optimizations at low levels. Specify **-qmaxmem=-1** to remove these memory limits.

-qnoprefetch

Prevents the insertion of prefetching machine instructions into your application during optimization.

-qinline

Exerts control over inlining optimization transformations. For more information on inlining, see the Advanced optimization concepts section.

-qsmallstack

Instructs the compiler to limit the use of stack storage in your application. This can increase heap usage.

-qsmp

Produces code for an SMP system. This option also searches for opportunities to increase performance by automatically parallelizing your code. The Parallel programming with XL Fortran section contains more information on writing parallel code.

-qstacktemp

Limits certain compiler temporaries allocated on the stack. Those not allocated on the stack will be allocated on the heap. This option is useful for applications that use enough stack space to exceed stack user or system limits.

-qstrict

Limits optimizations to strict adherence to implied program semantics. This often prevents the compiler from ignoring certain little-used rules in the IEEE floating-point specification that few applications require for correct behavior. For example, reordering or reassociating a sequence of floating-point calculations can cause floating-point exceptions at an unexpected location or mask them completely. The **-qstrict** option includes suboptions that refine the control of the transformations performed by the optimizers. Do not use this option unless your application requires strict adherence as **-qstrict** and its suboptions can severely inhibit optimization.

-qunroll

Independently controls loop unrolling. At **-O3** and higher, **-qunroll** is a default setting.

Options to assist with performance analysis

The compiler provides a set of options that can help you analyze the performance aspects of your application. These options are most useful when you are selecting your level of optimization and tuning the optimization process to the particular characteristics of your application.

-d Informs the compiler that you want to preserve the preprocessed versions of your compilation files. Typically these files would have a **.F** extension.

-g Inserts debugging information into your object code. You can use different **-g** levels to balance between debug capability and compiler optimization.

-p Inserts appropriate profiling information into your object code to make using tools for performance analysis possible. You can also specify this behavior with **-pg**.

-qlinedebug

An option similar to **-g**, this option inserts only minimal debugging information into your object code such as function names and line number information.

-qlist Produces a listing file containing a pseudo-assembly listing of your object code.

-qlistfmt

Creates a compiler report to assist with finding optimization opportunities.

-qreport

Inserts information in the listing file showing the transformations done by certain optimizations.

-S Produces a **.s** file containing the assembly version of the **.o** file produced by the compilation.

-qshowpdf

Enables the optimization process to insert additional profiling information into the compiled application. You can use the **showpdf** utility to view part of the profiling information of your application in text or XML format. For more information about profile-directed feedback (PDF), see Profile-directed feedback.

-qtbtable

Limits the amount of debugging traceback information in object files, which reduces the size of the program. Use **-qtbtable=full** if you intend to analyze your application with a profiling utility.

Options that can inhibit performance

Some compiler options are necessary for some applications to produce correct or repeatable results. Usually, these options instruct the compiler to enforce very strict language semantics that few applications require. Others are supported by the compiler to allow compilation of code that does not conform to language standards. Avoid these options if you are trying to increase the runtime performance of your application. In cases where these options are enabled by default, you must disable them to increase performance. You can specify **-qlistopt** to show, in the listing file, the settings of each of these options.

The following list summarizes the options that can inhibit performance. Each option is described in the *XL Fortran Compiler Reference*.

- -qalias=nostd
- -qcompact
- -qfloat=nosqrt, -qfloat=nostrictmaf, -qfloat=rrm
- -qsimd=noauto
- -qnoprefetch
- -qnounroll
- -qsmallstack
- -qstacktemp=[value other than 0 or -1]
- -qstrict
- -qstrict_induction
- -qstrictieemod
- -qunwind
- -qxf2008=checkpresence
- -qzerosize
- -qnoinline

Chapter 3. Advanced optimization concepts

After you apply command-line optimizations and tuning that are appropriate to your application and the constraints of your development cycle, you have opportunities to further improve the performance of your application through aliasing and inlining.

Aliasing

An alias occurs when different variables point directly or indirectly to a single area of storage. Aliasing refers to assumptions made during optimization about which variables can point to or occupy the same storage area.

When an alias exists, or the potential for an alias occurs during the optimization process, pessimistic aliasing occurs. This can inhibit optimizations like dead store elimination and loop transformations on aliased variables. Also, pessimistic aliasing can generate additional loads and stores as the compiler must ensure that any changes to the variable that occur through the alias are not lost.

When aliasing occurs there is less opportunity for optimization transformations to occur on and around aliased variables than variables where no aliasing has taken place. For example, if variables *A*, *B*, and *C* are all aliased, any optimization must assume that a store into or a use of *A* is also a store or a use of *B* and *C*, even if that is not the case. Some of the highest optimization levels can improve alias analysis and remove some pessimistic aliases. However, in all cases, when it is not proven during an optimization transformation that an alias can be removed that alias must be left in place.

Where possible, avoid programming techniques that lead to pessimistic aliasing assumptions. These aliasing assumptions are the single most limiting factor to optimization transformations. The following situations can lead to pessimistic aliasing:

- When you assign a pointer the address of any variable, the pointer can be aliased with globally visible variables and with static variables visible in the pointer's scope.
- When you call a procedure that has dummy arguments passed by reference, aliasing occurs for variables used as actual arguments, and for global variables.
- The compiler will make several worst-case aliasing assumptions concerning variables in common blocks and modules. These assumptions can inhibit optimization.

Some compiler options like `-qalias` can affect aliasing directly. For more information on how to tune the aliasing behavior in your application, see “Options for providing application characteristics” on page 38.

Inlining

Inlining is the process of replacing a subroutine or function call at the call site with the body of the subroutine or function being called. This eliminates call-linkage overhead and can expose significant optimization opportunities.

For example, with inlining, the compiler can replace the subroutine parameters in the function body with the actual arguments passed. Inlining trade-offs can include code bloat and an increase in the difficulty of debugging your source code.

If your application contains many calls to small procedures, the procedure call overhead can sometimes increase the execution time of the application considerably. Specifying the **-qinline** compiler option can reduce this overhead. Additionally, you can use the **-p** or **-pg** options and profiling tools to determine which subprograms your application calls most frequently, and use **-qinline** to list their names to ensure inlining.

The **-qinline** option can perform inlining where the calling and called procedures are in different compilation units. This applies to optimization level **-O5** only.

```
# Let the compiler decide what to inline.
xlf95 -O3 -qinline inline.f

# Encourage the compiler to inline particular subprograms.
xlf95 -O3 -qinline+called_100_times:called_1000_times inline.f
```

Note: **-qipa=inline** is deprecated and no longer supported; it is replaced by **-qinline**.

Finding the right level of inlining

A common occurrence in application optimization is excessive inlining. This can actually lead to a decrease in performance because running larger programs can cause more frequent cache misses and page faults. Because the XL compilers contain safeguards to prevent excessive inlining, this can lead to situations where subprograms you want to inline are not automatically inlined when you specify **-qinline**.

Some common conditions that prevent **-qinline** from inlining particular subprograms are:

- The calling and called procedures are in different compilation units. If so, you can use the **-qinline** option in the link step to enable cross-file inlining. This applies to optimization level **-O5** only.
- After inlining expands a subprogram to a particular limit, the optimizer does not inline subsequent calls to that subprogram.
- Any interface errors, such as different numbers, sizes, or types of arguments or return values, can prevent inlining for a subprogram call. You can also use interface blocks for the procedures being called.
- Actual or potential aliasing of dummy arguments or automatic variables can limit inlining. Consider the following cases:
 - There are more than 31 arguments to the procedure your application is calling.
 - Any automatic variables in the called procedures are involved in an **EQUIVALENCE** statement
 - The same variable argument is passed more than once in the same call. For example, `CALL SUB(X,Y,X)`.
- Some procedures that use computed **GO TO** statements, where any of the corresponding statement labels are also used in an **ASSIGN** statement.

To change the size limits that control inlining, you can specify **-qinline=level=n**, where *n* is 0 through 10. Larger values allow more inlining.

It is possible to inline C/C++ functions into Fortran programs and Fortran functions into C/C++ programs during link time optimizations. You must compile the C/C++ code using the IBM XL C/C++ compilers with **-qinline** and a compatible option set to that used in the IBM XL Fortran compilation.

Chapter 4. Managing code size

Code size is often not a detriment to performance for most XL compiler programmers. For some however, generating compact object code can be as important as generating efficient code.

Oversized programs can affect overall performance by creating a conflict for real storage between pages of virtual storage containing code, and pages of virtual storage containing data. On systems with a small, combined instruction and data cache, cache collisions between code and data can also reduce performance. This section provides suggestions on how to achieve a balance between code efficiency and object-module size, while identifying compiler options that can affect object-module size. Code size tuning is most effective once you have built a stable application and run optimization at **-O2** or higher.

Reasons for tuning for code size include:

- Your application design calls for an implementation with limited real memory, instruction-cache space, or disk space.
- When loading your application, it uses enough memory to create a conflict between code areas and data areas in real memory, and both code and data are frequently paged in and out.
- There are high activity areas in your code large enough that instruction cache and instruction Translation Lookaside Buffer (TLB) misses have a major effect on performance.
- You intend your application to run on a host that serves end users, or in a batch environment with limits on real memory.

Before tuning for code size, it is important for you to determine whether code size is the actual problem. Very large applications tend to have small clusters of high activity and large sections of infrequently accessed code. If a particular code page is not accessed in a particular run, that page is never loaded into memory, and has no negative impact on performance. If you are tuning for code size due to the high activity code segments that cause instruction cache and instruction TLB misses that have a major effect on performance, this can be symptomatic of a program structure that requires improvement or hardware not suited to the resource requirements of the application.

If your data takes up more real storage than is available, reducing code size can improve performance by ensuring that fewer pages of data are paged out as code is paged in. However, data blocking strategies are likely to prove both more effective and easier to implement. Processing data in each page as completely as possible before moving on to the next page can reduce the number of data page misses.

If you are coding an application for a machine with a combined instruction and data cache, you can improve performance by applying the techniques described later in this section, but tuning for data cache management can yield better results than code-size tuning. Also note that highly tuning your code for the cache characteristics of one system can lead to undesirable performance results if you execute your application elsewhere.

Steps for reducing code size

Reducing the code size of your application can have a positive effect on the performance of your application

Consider the following steps for reducing code size:

- Ensure that you have built a stable application that compiles at **-O2** or higher.
- Use performance analysis tools to isolate high activity code segments and tune for performance where appropriate. Basing decisions for code size tuning on an application that has already undergone performance analysis will give you more information on where your application could benefit from code size tuning.
- Use compiler options like **-qcompact** to help reduce code size. See *Compiler option influences on code size* for more information. Also see the following options in the *XL Fortran Compiler Reference*:
 - **-qinline**.
 - The *partition* parameter for **-qipa**.
 - **-qunroll**.

Be aware that optimization can cause code to expand significantly through loop unrolling, invariant **IF** floating, inlining, and other optimizations. The higher your optimization level, the more code size can increase. For more information on finding an optimization level appropriate for your application, see Chapter 1, “Optimizing your applications,” on page 1.

Compiler option influences on code size

High optimization levels can increase code size. You can use other compiler options to influence the size of your code and improve performance.

The **-qipa** compiler option

The **-qipa** option enables interprocedural analysis (IPA) by the compiler. Interprocedural analysis analyzes the relationships between procedures and the code that references those procedures, so that more optimizations within procedures and across procedure references can take place. Interprocedural analysis can decrease code size and improve performance at the same time. In some cases however, IPA inlining can increase code size. Use with discretion.

Related reference:



See interprocedural analysis (IPA) in the *Compiler Reference*

The **-qinline** inlining option

Using the **-qinline** compiler option, you can specify that the compiler consider all procedures, or a particular list of procedures for inlining. Inlining procedures can increase the performance of your application. However, if your program references a procedure from many different locations in the source code, inlining that procedure can increase code size dramatically. You can use **-qnoinline** to disable procedure inlining entirely. You can also partially disable inlining with **-qinline-<procedure_name>**.

Do not assume that all inlining increases code size. When your source code references a very small procedure many times, inlining can reduce code size, because inlining eliminates control transfer and data interface code. In addition, inlining code facilitates other optimizations at the point of inlining, by providing

information on the values of arguments referencing the procedure. If a procedure is very small and is referenced from a number of places, inlining can also increase code locality and reduce code paging.

For details about the **-qinline** compiler option, see **-qinline** in the *XL Fortran Compiler Reference*.

The **-qhot** compiler option

The loop analysis and optimization available when you specify **-qhot** can increase code size. If your application contains many large loops and loop optimization opportunities exist, **-qhot** can increase code size significantly along with performance. Specifying **-qhot=level=0** will perform minimal high-order transformations if code size is an issue. The topic High-order transformation contains more information on using **-qhot** effectively.

The **-qcompact** compiler option

The **-qcompact** compiler option instructs the compiler to avoid certain optimizing transformations that expand the object code. Compiling with **-qcompact**, disables many transformations, including:

- Loop unrolling
- Expansion of fixed-point multiply by more than one instruction
- Inline expansion of some string and memory manipulation functions. In some cases **-qcompact** will avoid inlining opportunities entirely.

Specifying **-qcompact** creates a trade-off between the performance of individual routines in your application, and overall system performance. Suppressing transformations degrades the performance of individual routines, while overall system performance can increase as a more compact program can provide some or all of the following:

- Fewer instruction-cache misses
- Fewer TLB misses for pages of application code
- Fewer page faults for application code

Other influences on code size

In addition to compiler options, there are a number of ways programming and analysis can influence the size of your source code.

High activity areas

Once you apply the techniques discussed earlier in this section, your strategy for further code size reduction depends on your objective. Use profiling tools to locate hot spots in your program; then follow one of the following guidelines:

- If you want to reduce code size to reduce program paging, concentrate on minimizing branches and procedure references within those hot spots.
- If you want to reduce code size to reduce the size of your program's files on disk, concentrate on areas that are *not* hot spots. Remove any expansive optimizations from code that does not contain hot spots.

Computed GOTOs and CASE constructs

A sparse computed **GOTO** can increase code size considerably. In a sparse computed **GOTO**, most statement labels point to the default. Consider the following example where label 10 is the default:

```

      GOTO (10,10,10,10,20,10,10,10,10,30,20,10,10,10,10,
+10,20,10,20,10,20,30,30,10,10,10,10,10,10,20,10,10,...
+10,20,30,10,10,10,30,10,10,10,10,10,10,20,10,30) IA(I)

      GOTO 10
30    CONTINUE
      ! ...
      GOTO 10
20    CONTINUE
      ! ...
10    CONTINUE

```

Although fewer cases are shown, the following **CASE** construct is functionally equivalent to the example above. *N* is the value of the largest integer that the computed **GOTO** or **CASE** construct is testing.

```

      INTEGER IA(10000)
      SELECT CASE (IA(I))
      CASE DEFAULT
        GOTO 10
      CASE (5)
        GOTO 20
      CASE (10)
        GOTO 30
      CASE (11)
        GOTO 20
      ! ...
      CASE (N-10)
        GOTO 30
      CASE (N-2)
        GOTO 20
      CASE (N)
        GOTO 30
      END SELECT

```

In both examples, the compiler builds a branch table in the object file that contains one entry for each possibility from 1 to *N*, where *N* is the largest integer value tested. The data section of the program stores this branch table. If *N* is very large, the table can increase both the size of the object file and the effects of data-cache misses.

If you use a **CASE** construct with a small number of cases and wide gaps between the test values of the cases, the compiler selects a different algorithm to dispatch to the appropriate location, and the resulting code can be more compact than a functionally equivalent computed **GOTO**. The compiler cannot determine that a computed **GOTO** has a default branch point, so the compiler assumes that any value in the range will be selected. In a **CASE** construct, the compiler assumes that cases you do not specify in the construct are handled as default.

Code size with dynamic or static linking

Dynamic or static linking each affect the size of your code, and the resulting performance of your application.

Dynamic linking and code size

When linking your programs, dynamic linking often ensures more compact code than linking statically. Dynamic linking does not include library procedures in your object file. Instead, a reference at run time causes the operating system to locate the dynamic library that contains the procedure, and reference that procedure from the library on the system. Only one copy of the procedure is in memory, even if several programs, or copies of a single program, are accessing the procedure

simultaneously. This can reduce paging overhead. However, any libraries your program references must be present in your application's execution environment.

Note that if your program references high performance libraries like BLAS or ESSL, these procedures are dynamically linked to your program by default.

Static linking and code size

Static linking binds library procedures into your application's object file. This can increase the size of your object file. If your program references only a small portion of the procedures available in a library, static linking can eliminate the need to provide the library to your users. However, static linking ties your application to one version of the library which can be detrimental in situations where your application will execute in different environments, such as different levels of the operating system.

Chapter 5. Debugging optimized code

Debugging optimized programs presents special usability problems. Optimization can change the sequence of operations, add or remove code, change variable data locations, and perform other transformations that make it difficult to associate the generated code with the original source statements.

For example:

Data location issues

With an optimized program, it is not always certain where the most current value for a variable is located. For example, a value in memory might not be current if the most current value is being stored in a register. Most debuggers cannot follow the removal of stores to a variable, and to the debugger it appears as though that variable is never updated, or possibly even never set. This contrasts with no optimization where all values are flushed back to memory and debugging can be more effective and usable.

Instruction scheduling issues

With an optimized program, the compiler might reorder instructions. That is, instructions might not be executed in the order you would expect based on the sequence of lines in the original source code. Also, the sequence of instructions for a statement might not be contiguous. As you step through the program with a debugger, the program might appear as if it is returning to a previously executed line in the code (interleaving of instructions).

Consolidating variable values

Optimizations can result in the removal and consolidation of variables. For example, if a program has two expressions that assign the same value to two different variables, the compiler might substitute a single variable. This can inhibit debug usability because a variable that a programmer is expecting to see is no longer available in the optimized program.

There are a couple of different approaches you can take to improve debug capabilities while also optimizing your program:

Debug non-optimized code first

Debug a non-optimized version of your program first, and then recompile it with your desired optimization options. See “Debugging in the presence of optimization” on page 54 for some compiler options that are useful in this approach.

Use -g level

Use the `-g` level suboption to control the amount of debugging information made available. Increasing it improves debug capability but prevents some optimizations. For more information, see `-g`.

Understanding different results in optimized programs

Here are some reasons why an optimized program might produce different results from one that has not undergone the optimization process:

- Optimized code can fail if a program contains code that is not valid. For example, failure can occur if the program passes an actual argument that also

appears in a common block in the called procedure, or if two or more dummy arguments are associated with the same actual argument. The optimization process relies on your application conforming to language standards.

- If a program that works without optimization fails when you optimize, check the cross-reference listing and the execution flow of the program for variables that are used before they are initialized. Compile with the **-qinitauto=hex_value** or **-qinitialloc=hex_value** option to try to produce the incorrect results consistently. For example, using **-qinitauto=FF** gives **REAL** and **COMPLEX** variables an initial value of "negative not a number" (-NAN). Any operations on these variables will also result in NAN values. Other bit patterns (*hex_value*) might yield different results and provide further clues as to what is going on. Programs with uninitialized variables can appear to work properly when compiled without optimization because of the default assumptions the compiler makes, but such programs might fail when you optimize. Similarly, a program can appear to execute correctly after optimization, but it fails at lower optimization levels or when it is run in a different environment. You can also use the **-qcheck=unset** option and **-qinfo=unset** option to detect variables that are not or might not be initialized.
- Referring to an automatic-storage variable by its address after the owning function has gone out of scope leads to a reference to a memory location that can be overwritten as other auto variables come into scope as new functions are called.

Use with caution debugging techniques that rely on examining values in storage, unless the **-g8** or **-g9** option is in effect and the optimization level is **-O2**. The compiler might have deleted or moved a common expression evaluation. It might have assigned some variables to registers so that they do not appear in storage at all.

Debugging in the presence of optimization

Debug and compile your program with your desired optimization options. Test the optimized program before placing it into production. If the optimized code does not produce the expected results, you can attempt to isolate the specific optimization problems in a debugging session.

The following list presents options that provide specialized information, which can be helpful during the debugging of optimized code:

- qlist** Instructs the compiler to emit an object listing. The object listing includes hex and pseudo-assembly representations of the generated instructions, traceback tables, and text constants.
- qreport**
Instructs the compiler to produce a report of the loop transformations it performed, how the program was parallelized, what inlining was done, and some other transformations. To generate a listing file, you must specify the **-qreport** option with at least one optimization option such as **-qhot**, **-qsmp**, **-qinline**, or **-qsimd**.
- qinfo=HOSTASSOCIATION**
Issues an informational message for an entity that is accessed by host association for the first time. For details, see **-qinfo**.
- qinfo=mt**
Reports potential synchronization issues in parallel code. For details, see **-qinfo**.

-qinfo=unset

Detects automatic variables that are used before they are set, and flags them with informational messages at compile time. For details, see `-qinfo`.

-qipa=list

Instructs the compiler to emit an object listing that provides information for IPA optimization.

-qcheck

Generates code that performs certain types of runtime checking.

-qsmp=noopt

If you are debugging SMP code, `-qsmp=noopt` ensures that the compiler performs only the minimum transformations necessary to parallelize your code and preserves maximum debug capability.

-qkeepparam

Ensures that procedure parameters are stored on the stack even during optimization. This can negatively impact execution performance. The `-qkeepparam` option then provides access to the values of incoming parameters to tools, such as debuggers, simply by preserving those values on the stack.

-qinitalloc

Instructs the compiler to emit code that initializes all allocatable and pointer variables that are allocated but not initialized to a given value.

-qinitauto

Instructs the compiler to emit code that initializes all automatic variables to a given value.

-g, -qdbg

Generates debugging information to be used by a symbolic debugger. You can use different `-g` or `-qdbg` levels to debug optimized code by viewing or possibly modifying accessible variables at selected source locations in the debugger. Higher `-g` or `-qdbg` levels provide a more complete debug support, while lower levels provide higher runtime performance. For details, see `-g` or `-qdbg`.

In addition, you can also use the **SNAPSHOT** directive to ensure that certain variables are visible to the debugger at points in your application. For details, see **SNAPSHOT**.

Chapter 6. Compiler-friendly programming techniques

Writing compiler-friendly code, with both the optimizer and portability in mind, can be as important to the performance of your application as the compilation options that you specify.

General practices

It is not necessary to hand-optimize your code, as hand-optimizing can introduce unusual constructs that can obscure the intentions of your application from the compiler and limit optimization opportunities.

Avoid breaking your program into too many small functions, as this can increase the percentage of time the program spends in dealing with call overhead. If you choose to use many small functions, compiling with **-qipa** can help minimize the impact on performance. Attempting to optimize an application with many small functions without the benefit of **-qipa** can severely limit the scope of other optimizations.

Use command invocations like **xlF90** and **xlF95**, which use **-qnosave**. The **-qnosave** option sets the default storage class of all variables to automatic. This provides more opportunities for optimization. When the **xlF** invocation command is used to compile the **.f**, **.F**, **.f77**, or **.F77** files, the default is **-qsave**. The **f77** and **fort77** invocation commands also use **-qsave** by default. All the other invocation commands use **-qnosave** by default.

Use modules to group related subroutines and functions.

Use module variables instead of common blocks for global storage.

Mark all code that accesses or manipulates data objects by independent I/O processes and independent, asynchronously interrupting processes as **VOLATILE**. For example, mark code that accesses shared variables and pointers to shared variables. Mark your code carefully however, as **VOLATILE** is a barrier to optimization as accessing a **VOLATILE** object forces the compiler to always load the value from storage. This prevents powerful optimizations such as constant propagation or invariant code motion.

The XL compilers support high performance libraries that can provide significant advantages over custom implementations or generic libraries.

Variables and pointers

The effective use of aliasing and of variables and pointers provides opportunities for improved performance and further optimization.

Obey all aliasing rules. Avoid specifying **-qalias=nostd**. For more information on aliasing and how it can affect performance, see “Aliasing” on page 43.

Avoid unnecessary use of global variables and pointers, including module variables and common blocks. When using global variables and pointers in a loop, load them into a local variable before the loop and store them back after. If you do not use the local variable somewhere other than in the loop body, the optimization

process can usually recognize what you are doing and expose more optimization opportunities. Replacing a global variable in a loop with a local variable reduces the possibilities for aliasing.

Use the **INTENT** statement to describe the usage of dummy arguments.

Limit the use of **ALLOCATABLE** objects and **POINTER** variables to situations demanding dynamic memory allocation.

Arrays

Where possible, use local variables instead of global variables for loop index variables and bounds.

Whenever possible, ensure references to arrays or array sections refer to contiguous blocks of storage. Noncontiguous memory array references, when passed as parameters, lead to copy-in and copy-out operations.

F2008 When declaring an array pointer or an assumed-shape array, you can use the **CONTIGUOUS** attribute to ensure that the array elements in order are stored in contiguous memory and not separated by other data objects. An array pointer with the **CONTIGUOUS** attribute can only be pointer associated with a contiguous target. An assumed-shape array with the **CONTIGUOUS** attribute is always contiguous; however, the corresponding actual argument can be contiguous or noncontiguous. If it is noncontiguous, the compiler makes it contiguous by creating a temporary contiguous argument. When the **CONTIGUOUS** attribute is used, the compiler can perform appropriate semantic check and detect invalid codes, which helps you write more optimized codes and enables the compiler to further optimize the runtime performance and storage layout. **F2008**

Keep your array expressions simple so that the optimizer can deduce access patterns more easily and reuse index calculations in whole or in part.

Frequent use of array-to-array assignment and **WHERE** constructs can impact performance by increasing temporary storage and creating loops. Using **-qlist** or **-qreport** can help you understand the performance characteristics of your code, and where applying **-qhot** could be beneficial. If you are already optimizing with **-qipa**, ensure you are using the **list=filename** option, so that the **-qlist** listing file is not overwritten.

Related information

- **F2008** The **CONTIGUOUS** attribute **F2008**

Choosing appropriate variable sizes

Improve the efficiency of your application by choosing the appropriate variable sizes.

When programming SMP applications, use the **CONTAINS** statement only to share thread local storage.

In most cases using **INTEGER(8)** for scalars improves the efficiency of DO loops, subscripting, mathematical calculations and calling conventions when passing objects. However, if your code contains large arrays with values that can fit in an **INTEGER(4)**, using smaller kind parameters can actually improve memory efficiency by reducing memory traffic to load or store data.

Use the lowest floating-point precision appropriate to your application. Higher precisions can reduce performance, so use the **REAL(16)**, or **COMPLEX(16)** data types only when you require extremely high precision.

On systems with VMX, using **REAL(4)** and **-qsimd=auto** provides opportunities for short vectorization that is not available with larger floating-point types. On systems with VSX, **-qsimd=auto** provides opportunities for vectorization on the **REAL(8)** type.

Submodules (Fortran 2008)

The submodule feature provides more structural facilities for modules.

When you compile a source file that contains submodules, a submodule symbol file named *ancestormodulename_submodulename.smod* is generated for each submodule. These output *.smod* files are to be used as input when you compile the descendant submodules.

You can use a module to declare the interfaces of module procedures and the descendant submodules to implement those module procedures. If the implementation of the procedures is changed, but their interfaces remain the same, you are not required to recompile the file that contains the module. An *.smod* file of a submodule is the prerequisite of its descendant submodules only.

A submodule extends a module or another submodule and can have its descendant submodules. You can put entities at intermediate levels that are shared by the descendant submodules at lower levels. Changing these entities cannot change the interpretation of anything that is accessible from the module by use association. Users of modules that embody large complicated concepts can organize components of the concept into submodules. At the same time, they can prevent the privacy of entities that is shared by the submodules and that is not to be displayed to the module users. In addition, putting these shared entities at an intermediate level also prevents cascades of reprocessing and testing if some of them are changed.

Because submodules cannot be accessed by use association, two submodules of different modules can access the ancestor module of each other through use association without causing circular dependency.

Example

The following example illustrates four modules with their descendant submodules and a main program.

- A module *m1*, which has a submodule *m1sub*.
- A module *m2*, which has a submodule *m2sub*, which in turn has a submodule *m2sub2*.
- Modules *m3* and *m4*, which do not have descendant submodules.

The module *m1*, *m2*, and *m4* are defined as follows. Both *m2* and *m4* use *m1* in host associated scope.

```
MODULE m1
  TYPE Base
    INTEGER :: i
  END TYPE

  INTERFACE
```

```

        MODULE SUBROUTINE sub1(i, b) ! Module procedure interface body for sub1
            INTEGER, INTENT(IN) :: i
            TYPE(Base), INTENT(IN) :: b
        END SUBROUTINE
    END INTERFACE
END MODULE

MODULE m2
    USE m1 ! Use association of module m1

    INTERFACE
        REAL MODULE FUNCTION func1() ! Module procedure interface body for func1
        END FUNCTION

        MODULE FUNCTION func2(b) ! Module procedure interface body for func2
            TYPE(Base) :: b
            TYPE(Base) :: func2
        END FUNCTION
    END INTERFACE
END MODULE

MODULE m4
    USE m1 ! Use association of module m1
    TYPE, EXTENDS(Base) :: NewType
    REAL :: j
    END TYPE
END MODULE

```

The submodule `m1sub`, which extends module `m1`, and submodule `m2sub`, which extends module `m2`, are defined as follows. The use association of module `m4` in `m1sub` does not cause circular reference.

```

SUBMODULE (m1) m1sub
    USE m4 ! Use association of module m4

    CONTAINS
        MODULE SUBROUTINE sub1(i, b) ! Implementation of sub1 declared in m1
            INTEGER, INTENT(IN) :: i
            TYPE(Base), INTENT(IN) :: b
            PRINT *, "sub1", i, b
        END SUBROUTINE
    END SUBMODULE

SUBMODULE (m2) m2sub

    CONTAINS
        REAL MODULE FUNCTION func1() ! Implementation of func1 declared in m2
            func1 = 20
        END FUNCTION
    END SUBMODULE

```

The third level submodule `m2sub2`, which extends its parent submodule `m2sub`, is defined as follows.

```

SUBMODULE (m2:m2sub) m2sub2

    CONTAINS
        MODULE FUNCTION func2(b) ! Implementation of func2 declared in m2
            TYPE(Base) :: b
            TYPE(Base) :: func2
            func2 = b
        END FUNCTION
    END SUBMODULE

```

The module `m3` is defined as follows. Type `Base` is still accessible by host association of `m1` in `m2`.

```

MODULE m3
  INTERFACE
    SUBROUTINE interfaceSub1(i, b)
      USE m1
      INTEGER, INTENT(IN) :: i
      TYPE(Base), INTENT(IN) :: b
    END SUBROUTINE

    REAL FUNCTION interfaceFunc1()
    END FUNCTION

    FUNCTION interfaceFunc2(b)
      USE m1
      TYPE(Base) :: b
      TYPE(Base) :: interfaceFunc2
    END FUNCTION
  END INTERFACE

  TYPE Container
    PROCEDURE(interfaceSub1), NOPASS, POINTER :: pp1
    PROCEDURE(interfaceFunc1), NOPASS, POINTER :: pp2
    PROCEDURE(interfaceFunc2), NOPASS, POINTER :: pp3
  END TYPE
END MODULE

```

The program example, which uses m1, m2, and m3, is defined as follows.

```

PROGRAM example
  USE m1
  USE m2
  USE m3
  TYPE(Container) :: c1
  c1%pp1 => sub1
  c1%pp2 => func1
  c1%pp3 => func2

  CALL c1%pp1(10, Base(11))
  PRINT *, "func1", int(c1%pp2())
  PRINT *, "func2", c1%pp3(Base(5))
END PROGRAM

```

When you compile the source files that contain the submodules m1sub, m2sub, and m2sub2, the following submodule symbol files are generated:

```

m1_m1sub.smod
m2_m2sub.smod
m2_m2sub2.smod

```

Related information

- Submodules
- The SUBMODULE statement
- XL Fortran input files
- XL Fortran output files

Chapter 7. High performance libraries

XL Fortran is shipped with the following set of libraries for high-performance mathematical computing:

- **Mathematical Acceleration Subsystem (MASS).** It is a set of libraries of tuned mathematical intrinsic routines that provide improved performance over the corresponding standard system math library routines. MASS is described in “Using the Mathematical Acceleration Subsystem (MASS) libraries.”
- **Basic Linear Algebra Subprograms (BLAS).** They are a subset of routines from IBM's Engineering and Scientific Subroutine Library (ESSL) library, which provides matrix/vector multiplication functions tuned for PowerPC architectures. The BLAS functions are described in “Using the Basic Linear Algebra Subprograms – BLAS” on page 75.

Note that if you are going to link your application with the ESSL libraries, using `-qessl` and IPA allows the optimizer to automatically use ESSL routines.

Using the Mathematical Acceleration Subsystem (MASS) libraries

XL Fortran is shipped with a set of Mathematical Acceleration Subsystem (MASS) libraries for high-performance mathematical computing.

The MASS libraries consist of a library of scalar Fortran routines described in “Using the scalar library” on page 64, a set of vector libraries tuned for specific architectures described in “Using the vector libraries” on page 66, and a set of SIMD libraries tuned for specific architectures described in “Using the SIMD libraries” on page 70. The functions contained in both scalar and vector libraries are automatically called at certain levels of optimization, but you can also call them explicitly in your programs. Note that accuracy and exception handling might not be identical in MASS functions and system library functions.

The MASS functions must run with the default rounding mode and floating-point exception trapping settings.

When you compile programs with any of the following sets of options:

- **`-qhot -qnostrict`**
- **`-qhot -O3 -qstrict=nolibrary`**
- **`-qhot -O3`**
- **`-O4`**
- **`-O5`**

the compiler automatically attempts to vectorize calls to system math functions by calling the equivalent MASS vector functions (with the exceptions of functions `vatan2`, `vsatan2`, `vdnint`, `vdint`, `vcosisin`, `vscosisin`, `vqdrft`, `vsqdrft`, `vrqdrft`, `vsrqdrft`, `vpopcnt4`, `vpopcnt8`, `vexp2`, `vexp2m1`, `vsexp2`, `vsexp2m1`, `vlog2`, `vlog21p`, `vslog2`, and `vslog21p`). If it cannot vectorize, it automatically tries to call the equivalent MASS scalar functions. For automatic vectorization or scalarization, the compiler uses versions of the MASS functions contained in the XLOPT library `libxlopt.a`.

In addition to any of the preceding sets of options, when the `-qipa` option is in effect, if the compiler cannot vectorize, it tries to inline the MASS scalar functions before deciding to call them.

“Compiling and linking a program with MASS” on page 74 describes how to compile and link a program that uses the MASS libraries, and how to selectively use the MASS scalar library functions in conjunction with the regular system libraries.

Related external information

 Mathematical Acceleration Subsystem website, available at <http://www.ibm.com/software/awdtools/mass/>

Using the scalar library

The MASS scalar library `libmass.a` contains an accelerated set of frequently used math intrinsic functions that provide improved performance over the corresponding standard system library functions. The MASS scalar functions are used when you explicitly link `libmass.a`.

If you want to explicitly call the MASS scalar functions, you can take the following steps:

1. Link the MASS scalar library `libmass.a` with your application. For instructions, see “Compiling and linking a program with MASS” on page 74
2. All the MASS scalar routines, except those listed in step 3 are recognized by XL Fortran as intrinsic functions, so no explicit interface block is needed. To provide an interface block for the functions listed in step 3, include `mass.include` in your source file.
3. Include `mass.include` in your source file for the following functions:
 - `acosf`, `acoshf`, `asinf`, `asinhf`, `atan2f`, `atanf`, `atanhf`, `cbrt`, `cbrtf`, `copysign`, `copysignf`, `cosf`, `coshf`, `cosisin`, `erff`, `erfcf`, `expf`, `expm1f`, `hypotf`, `lgammaf`, `logf`, `log10f`, `log1pf`, `rsqrt`, `sinf`, `sincos`, `sinhf`, `tanf`, `tanhf`, and `x**y`

The MASS scalar functions accept double-precision parameters and return a double-precision result, or accept single-precision parameters and return a single-precision result, except `sincos` which gives 2 double-precision results. They are summarized in Table 13.

Table 13. MASS scalar functions

Double-precision function	Single-precision function	Arguments	Description
<code>acos</code>	<code>acosf</code>	(x)	Returns the arccosine of x
<code>acosh</code>	<code>acoshf</code>	(x)	Returns the hyperbolic arccosine of x
	<code>anint</code>	(x)	Returns the rounded integer value of x
<code>asin</code>	<code>asinf</code>	(x)	Returns the arcsine of x
<code>asinh</code>	<code>asinhf</code>	(x)	Returns the hyperbolic arcsine of x
<code>atan2</code>	<code>atan2f</code>	(x, y)	Returns the arctangent of x/y
<code>atan</code>	<code>atanf</code>	(x)	Returns the arctangent of x
<code>atanh</code>	<code>atanhf</code>	(x)	Returns the hyperbolic arctangent of x
<code>cbrt</code>	<code>cbrtf</code>	(x)	Returns the cube root of x
<code>copysign</code>	<code>copysignf</code>	(x, y)	Returns x with the sign of y

Table 13. MASS scalar functions (continued)

Double-precision function	Single-precision function	Arguments	Description
cos	cosf	(x)	Returns the cosine of x
cosh	coshf	(x)	Returns the hyperbolic cosine of x
cosisin		(x)	Returns a complex number with the real part the cosine of x and the imaginary part the sine of x.
dnint		(x)	Returns the nearest integer to x (as a double)
erf	erff	(x)	Returns the error function of x
erfc	erfcf	(x)	Returns the complementary error function of x
exp	expf	(x)	Returns the exponential function of x
expm1	expm1f	(x)	Returns (the exponential function of x) - 1
hypot	hypotf	(x,y)	Returns the square root of $x^2 + y^2$
lgamma	lgammaf	(x)	Returns the natural logarithm of the absolute value of the Gamma function of x
log	logf	(x)	Returns the natural logarithm of x
log10	log10f	(x)	Returns the base 10 logarithm of x
log1p	log1pf	(x)	Returns the natural logarithm of (x + 1)
rsqrt		(x)	Returns the reciprocal of the square root of x
sin	sinf	(x)	Returns the sine of x
sincos		(x,s,c)	Sets s to the sine of x and c to the cosine of x
sinh	sinhf	(x)	Returns the hyperbolic sine of x
sqrt		(x)	Returns the square root of x
tan	tanf	(x)	Returns the tangent of x
tanh	tanhf	(x)	Returns the hyperbolic tangent of x
x**y		(x,y)	Returns x raised to the power y

The MASS library interfaces include the following features:

- The scalar functions have generic interfaces so that the same name (the name used for the real*8 function in previous versions) can be called with either real*4 or real*8 arguments.
- The scalar functions are marked pure. You can call them from pure procedures.
- The scalar functions are marked elemental. You can call them with an array argument and apply them to all the array elements.
- The intent of the argument is specified to assist in compiler error checking.

The following example shows the XL Fortran interface declaration of the acos and acosf scalar functions:

```
INTERFACE acos
  PURE ELEMENTAL REAL*8 FUNCTION acos (x)
    REAL*8, value :: x
```

```

END FUNCTION

PURE ELEMENTAL REAL*4 FUNCTION acosf (x)
  REAL*4, value :: x
END FUNCTION
END INTERFACE

```

The following example shows the XL Fortran interface declaration for the `rsqrt` scalar function:

```

INTERFACE
  ! Returns the reciprocal of the square root of x.
  REAL(8) FUNCTION rsqrt(x)
    REAL(8), value :: x
  END FUNCTION
END INTERFACE

```

Although most of the scalar MASS functions have separate implementations tuned for optimal performance with `real*4` and `real*8` arguments, the functions `cosisin`, `rsqrt`, and `sincos` have only `real*8` versions. These functions have only the `real*8` interface in `mass.include`, but they can be called with `real*4` or `real*8` arguments and will operate correctly.

Notes:

- The trigonometric functions (`sin`, `cos`, `tan`) return NaN (Not-a-Number) for large arguments (where the absolute value is greater than $2^{50}\pi$).
- In some cases, the MASS functions are not as accurate as the ones in the `libm.a` library, and they might handle edge cases differently (`sqrt(Inf)`, for example).
- For accuracy comparisons with `libm.a`, see Product documentation (manuals) in the Product support content section of the Mathematical Acceleration Subsystem website.

Related external information

 Mathematical Acceleration Subsystem website, available at <http://www.ibm.com/software/awdtools/mass/>

Using the vector libraries

If you want to explicitly call any of the MASS vector functions, you can do so by including `massv.include` in your source files and linking your application with the appropriate vector library. Information about linking is provided in “Compiling and linking a program with MASS” on page 74.

The vector libraries shipped with XL Fortran are listed below:

libmassv.a

The generic vector library that runs on any supported POWER® processor. Unless your application requires this portability, use the appropriate architecture-specific library below for maximum performance.

libmassvp8.a

Contains functions that are tuned for the POWER8® architecture.

The single-precision and double-precision floating-point functions contained in the vector libraries are summarized in Table 14 on page 67. The integer functions contained in the vector libraries are summarized in Table 15 on page 68.

With the exception of a few functions (described in the following paragraph), all of the floating-point functions in the vector libraries accept three arguments:

- A double-precision (for double-precision functions) or single-precision (for single-precision functions) vector output argument.
- A double-precision (for double-precision functions) or single-precision (for single-precision functions) vector input argument.
- An integer vector-length argument.

The functions are of the form

function_name (*y,x,n*)

where *y* is the target vector, *x* is the source vector, and *n* is the vector length. The arguments *y* and *x* are assumed to be double-precision for functions with the prefix *v*, and single-precision for functions with the prefix *vs*. As an example, the following code outputs a vector *y* of length 500 whose elements are $\exp(x(i))$, where $i=1,\dots,500$:

```
include 'massv.include'

real(8) x(500), y(500)
integer n
n = 500
...
call vexp (y, x, n)
```

The functions *vdiv*, *vsincos*, *vpow*, and *vatan2* (and their single-precision versions, *vsdiv*, *vssincos*, *vspow*, and *vsatan2*) take four arguments. The functions *vdiv*, *vpow*, and *vatan2* take the arguments (*z,x,y,n*). The function *vdiv* outputs a vector *z* whose elements are $x(i)/y(i)$, where $i=1,\dots,n$. The function *vpow* outputs a vector *z* whose elements are $x(i)^{y(i)}$, where $i=1,\dots,n$. The function *vatan2* outputs a vector *z* whose elements are $\text{atan}(x(i)/y(i))$, where $i=1,\dots,n$. The function *vsincos* takes the arguments (*y,z,x,n*), and outputs two vectors, *y* and *z*, whose elements are $\sin(x(i))$ and $\cos(x(i))$, respectively.

In *vcosisin*(*y,x,n*) and *vscosisin*(*y,x,n*), *x* is a vector of *n* elements and the function outputs a vector *y* of *n* complex(8) (for *vcosisin*) or complex(4) (for *vscosisin*) elements of the form $(\cos(x(i)),\sin(x(i)))$.

Table 14. MASS floating-point vector library functions

Double-precision function	Single-precision function	Arguments	Description
<i>vacos</i>	<i>vsacos</i>	(<i>y,x,n</i>)	Sets <i>y</i> (<i>i</i>) to the arc cosine of <i>x</i> (<i>i</i>), for $i=1,\dots,n$
<i>vacosh</i>	<i>vsacosh</i>	(<i>y,x,n</i>)	Sets <i>y</i> (<i>i</i>) to the hyperbolic arc cosine of <i>x</i> (<i>i</i>), for $i=1,\dots,n$
<i>vasin</i>	<i>vsasin</i>	(<i>y,x,n</i>)	Sets <i>y</i> (<i>i</i>) to the arc sine of <i>x</i> (<i>i</i>), for $i=1,\dots,n$
<i>vasinh</i>	<i>vsasinh</i>	(<i>y,x,n</i>)	Sets <i>y</i> (<i>i</i>) to the arc hyperbolic sine of <i>x</i> (<i>i</i>), for $i=1,\dots,n$
<i>vatan2</i>	<i>vsatan2</i>	(<i>z,x,y,n</i>)	Sets <i>z</i> (<i>i</i>) to the arc tangent of <i>x</i> (<i>i</i>)/ <i>y</i> (<i>i</i>), for $i=1,\dots,n$
<i>vatanh</i>	<i>vsatanh</i>	(<i>y,x,n</i>)	Sets <i>y</i> (<i>i</i>) to the arc hyperbolic tangent of <i>x</i> (<i>i</i>), for $i=1,\dots,n$
<i>vcbirt</i>	<i>vscbrt</i>	(<i>y,x,n</i>)	Sets <i>y</i> (<i>i</i>) to the cube root of <i>x</i> (<i>i</i>), for $i=1,\dots,n$
<i>vcos</i>	<i>vscos</i>	(<i>y,x,n</i>)	Sets <i>y</i> (<i>i</i>) to the cosine of <i>x</i> (<i>i</i>), for $i=1,\dots,n$
<i>vcosh</i>	<i>vscosh</i>	(<i>y,x,n</i>)	Sets <i>y</i> (<i>i</i>) to the hyperbolic cosine of <i>x</i> (<i>i</i>), for $i=1,\dots,n$
<i>vcosisin</i>	<i>vscosisin</i>	(<i>y,x,n</i>)	Sets the real part of <i>y</i> (<i>i</i>) to the cosine of <i>x</i> (<i>i</i>) and the imaginary part of <i>y</i> (<i>i</i>) to the sine of <i>x</i> (<i>i</i>), for $i=1,\dots,n$
<i>vdint</i>		(<i>y,x,n</i>)	Sets <i>y</i> (<i>i</i>) to the integer truncation of <i>x</i> (<i>i</i>), for $i=1,\dots,n$
<i>vdiv</i>	<i>vsdiv</i>	(<i>z,x,y,n</i>)	Sets <i>z</i> (<i>i</i>) to <i>x</i> (<i>i</i>)/ <i>y</i> (<i>i</i>), for $i=1,\dots,n$

Table 14. MASS floating-point vector library functions (continued)

Double-precision function	Single-precision function	Arguments	Description
vdnint		(y,x,n)	Sets y(i) to the nearest integer to x(i), for i=1,..,n
verf	vserf	(y,x,n)	Sets y(i) to the error function of x(i), for i=1,..,n
verfc	vserfc	(y,x,n)	Sets y(i) to the complimentary error function of x(i), for i=1,..,n
vexp	vsexp	(y,x,n)	Sets y(i) to the exponential function of x(i), for i=1,..,n
vexp2	vsexp2	(y,x,n)	Sets y(i) to 2 raised to the power of x(i), for i=1,..,n
vexpm1	vsexpm1	(y,x,n)	Sets y(i) to (the exponential function of x(i)) -1, for i=1,..,n
vexp2m1	vsexp2m1	(y,x,n)	Sets y(i) to (2 raised to the power of x(i)) -1, for i=1,..,n
vhypot	vshypot	(z,x,y,n)	Sets z(i) to the square root of the sum of the squares of x(i) and y(i), for i=1,..,n
vlog	vslog	(y,x,n)	Sets y(i) to the natural logarithm of x(i), for i=1,..,n
vlog2	vslog2	(y,x,n)	Sets y(i) to the base-2 logarithm of x(i), for i=1,..,n
vlog10	vslog10	(y,x,n)	Sets y(i) to the base-10 logarithm of x(i), for i=1,..,n
vlog1p	vslog1p	(y,x,n)	Sets y(i) to the natural logarithm of (x(i)+1), for i=1,..,n
vlog21p	vslog21p	(y,x,n)	Sets y(i) to the base-2 logarithm of (x(i)+1), for i=1,..,n
vpow	vspow	(z,x,y,n)	Sets z(i) to x(i) raised to the power y(i), for i=1,..,n
vqdrft	vsqdrft	(y,x,n)	Sets y(i) to the 4th root of x(i), for i=1,..,n
vrcbrt	vsrbrt	(y,x,n)	Sets y(i) to the reciprocal of the cube root of x(i), for i=1,..,n
vrec	vsrec	(y,x,n)	Sets y(i) to the reciprocal of x(i), for i=1,..,n
vrqdrft	vsrqdrft	(y,x,n)	Sets y(i) to the reciprocal of the 4th root of x(i), for i=1,..,n
vrsqrt	vsrsqrt	(y,x,n)	Sets y(i) to the reciprocal of the square root of x(i), for i=1,..,n
vsin	vssin	(y,x,n)	Sets y(i) to the sine of x(i), for i=1,..,n
vsincos	vssincos	(y,z,x,n)	Sets y(i) to the sine of x(i) and z(i) to the cosine of x(i), for i=1,..,n
vsinh	vssinh	(y,x,n)	Sets y(i) to the hyperbolic sine of x(i), for i=1,..,n
vsqrt	vssqrt	(y,x,n)	Sets y(i) to the square root of x(i), for i=1,..,n
vtan	vstan	(y,x,n)	Sets y(i) to the tangent of x(i), for i=1,..,n
vtanh	vstanh	(y,x,n)	Sets y(i) to the hyperbolic tangent of x(i), for i=1,..,n

Integer functions are of the form *function_name* (x, n), where x is a vector of 4-byte (for vpopcnt4) or 8-byte (for vpopcnt8) numeric objects (integer or floating-point), and n is the vector length.

Table 15. MASS integer vector library functions

Function	Description	Interface
vpopcnt4	Returns the total number of 1 bits in the concatenation of the binary representation of x(i), for i=1,..,n, where x is vector of 32-bit objects	integer*4 function vpopcnt4 (x, n) integer*4 x(*), n

Table 15. MASS integer vector library functions (continued)

Function	Description	Interface
vpopcnt8	Returns the total number of 1 bits in the concatenation of the binary representation of x(i), for i=1,...,n, where x is vector of 64-bit objects	integer*4 function vpopcnt8 (x, n) integer*8 x(*) integer*4 n

The following example shows XL Fortran interface declarations for some of the MASS single-precision and double-precision functions:

```

INTERFACE vsqrt
  ! Sets y(i) to the square root of x(i), for i=1,...,n
  PURE SUBROUTINE vsqrt (y, x, n)
    REAL*8, INTENT(OUT) :: y(*)
    REAL*8, INTENT(IN)  :: x(*)
    INTEGER*4, INTENT(IN) :: n
  END SUBROUTINE

  PURE SUBROUTINE vssqrt (y, x, n)
    REAL*4, INTENT(OUT) :: y(*)
    REAL*4, INTENT(IN)  :: x(*)
    INTEGER*4, INTENT(IN) :: n
  END SUBROUTINE
END INTERFACE

```

Overlap of input and output vectors

In most applications, the MASS vector functions are called with disjoint input and output vectors; that is, the two vectors do not overlap in memory. Another common usage scenario is to call them with the same vector for both input and output parameters (for example, vsin (y, y, n)). Other kinds of overlap (where input and output vectors are neither disjoint nor identical) should be avoided, since they might produce unexpected results:

- For calls to vector functions that take one input and one output vector (for example, vsin (y, x, n)):

The vectors x(1:n) and y(1:n) must be either disjoint or identical, or unexpected results might be obtained.
- For calls to vector functions that take two input vectors (for example, vatan2 (y, x1, x2, n)):

The previous restriction applies to both pairs of vectors y,x1 and y,x2. That is, y(1:n) and x1(1:n) must be either disjoint or identical; and y(1:n) and x2(1:n) must be either disjoint or identical.
- For calls to vector functions that take two output vectors (for example, vsincos (y1, y2, x, n)):

The above restriction applies to both pairs of vectors y1,x and y2,x. That is, y1(1:n) and x(1:n) must be either disjoint or identical; and y2(1:n) and x(1:n) must be either disjoint or identical. Also, the vectors y1(1:n) and y2(1:n) must be disjoint.

Alignment of input and output vectors

To get the best performance from the POWER8 vector libraries, align the input and output vectors on 8-byte (or better, 16-byte) boundaries.

Consistency of MASS vector functions

All the functions in the MASS vector libraries are consistent, in the sense that a given input value will always produce the same result, regardless of its position in the vector, and regardless of the vector length.

Related external information

 Mathematical Acceleration Subsystem website, available at <http://www.ibm.com/software/awdtools/mass/>

Using the SIMD libraries

The MASS SIMD library `libmass_simdp8.a` contains a set of frequently used math intrinsic functions that provide improved performance over the corresponding standard system library functions. If you want to use the MASS SIMD functions, you can do so as follows:

1. Provide the interfaces for the functions by including `mass_simd.include` in your source files.
2. Link the MASS SIMD library `libmass_simdp8.a` with your application. For instructions, see “Compiling and linking a program with MASS” on page 74.

The single-precision MASS SIMD functions accept single-precision arguments and return single-precision results. Likewise, the double-precision MASS SIMD functions accept double-precision arguments and return double-precision results. They are summarized in Table 16.

Table 16. MASS SIMD functions

Double-precision function	Single-precision function	Description	Double-precision function interface	Single-precision function interface
<code>acosd2</code>	<code>acosf4</code>	Computes the arc cosine of each element of <code>vx</code> .	<code>vector(real(8)) function acosd2(vx)</code> <code>vector(real(8)), value :: vx</code>	<code>vector(real(4)) function acosf4(vx)</code> <code>vector(real(4)), value :: vx</code>
<code>acoshd2</code>	<code>acoshf4</code>	Computes the arc hyperbolic cosine of each element of <code>vx</code> .	<code>vector(real(8)) function acoshd2(vx)</code> <code>vector(real(8)), value :: vx</code>	<code>vector(real(4)) function acoshf4(vx)</code> <code>vector(real(4)), value :: vx</code>
<code>asind2</code>	<code>asinf4</code>	Computes the arc sine of each element of <code>vx</code> .	<code>vector(real(8)) function asind2(vx)</code> <code>vector(real(8)), value :: vx</code>	<code>vector(real(4)) function asinf4(vx)</code> <code>vector(real(4)), value :: vx</code>
<code>asinhd2</code>	<code>asinhf4</code>	Computes the arc hyperbolic sine of each element of <code>vx</code> .	<code>vector(real(8)) function asinhd2(vx)</code> <code>vector(real(8)), value :: vx</code>	<code>vector(real(4)) function asinhf4(vx)</code> <code>vector(real(4)), value :: vx</code>
<code>atand2</code>	<code>atanf4</code>	Computes the arc tangent of each element of <code>vx</code> .	<code>vector(real(8)) function atand2(vx)</code> <code>vector(real(8)), value :: vx</code>	<code>vector(real(4)) function atanf4(vx)</code> <code>vector(real(4)), value :: vx</code>
<code>atan2d2</code>	<code>atan2f4</code>	Computes the arc tangent of each element of <code>vx/vy</code> .	<code>vector(real(8)) function atan2d2(vx,vy)</code> <code>vector(real(8)), value :: vx, vy</code>	<code>vector(real(4)) function atan2f4(vx,vy)</code> <code>vector(real(4)), value :: vx, vy</code>

Table 16. MASS SIMD functions (continued)

Double-precision function	Single-precision function	Description	Double-precision function interface	Single-precision function interface
atanhd2	atanhf4	Computes the arc hyperbolic tangent of each element of vx.	vector(real(8)) function atanh2(vx) vector(real(8)), value :: vx	vector(real(4)) function atanhf4(vx) vector(real(4)), value :: vx
cbrtd2	cbrtf4	Computes the cube root of each element of vx	vector(real(8)) function cbrtd2(vx) vector(real(8)), value :: vx	vector(real(4)) function cbrtf4(vx) vector(real(4)), value :: vx
cosd2	cosf4	Computes the cosine of each element of vx.	vector(real(8)) function cosd2(vx) vector(real(8)), value :: vx	vector(real(4)) function cosf4(vx) vector(real(4)), value :: vx
coshd2	coshf4	Computes the hyperbolic cosine of each element of vx.	vector(real(8)) function coshd2(vx) vector(real(8)), value :: vx	vector(real(4)) function coshf4(vx) vector(real(4)), value :: vx
cosisind2	cosisinf4	Computes the cosine and sine of each element of x, and stores the results in y and z as follows: cosisind2 (x, y, z) sets the elements of y to cos(x1), sin(x1), and the elements of z to cos(x2), sin(x2), where x1, x2 are the elements of x. cosisinf4 (x,y,z) sets the elements of y to cos(x1), sin(x1), cos(x2), sin(x2), and the elements of z to cos(x3), sin(x3), cos(x4), sin(x4), where x1, x2, x3, x4 are the elements of x.	subroutine cosisind2 (x, y, z) vector(real(8)), value :: x vector(real(8)) y, z	subroutine cosisinf4 (x, y, z) vector(real(4)), value :: x vector(real(4)) y, z
divd2	divf4	Computes the quotient vx/vy.	vector(real(8)) function divd2(vx, vy) vector(real(8)), value :: vx, vy	vector(real(4)) function divf4(vx, vy) vector(real(4)), value :: vx, vy

Table 16. MASS SIMD functions (continued)

Double-precision function	Single-precision function	Description	Double-precision function interface	Single-precision function interface
erfcd2	erfcf4	Computes the complementary error function of each element of vx.	vector(real(8)) function erfcd2(vx) vector(real(8)), value :: vx	vector(real(4)) function erfcf4(vx) vector(real(4)), value :: vx
erfd2	erff4	Computes the error function of each element of vx.	vector(real(8)) function erfd2(vx) vector(real(8)), value :: vx	vector(real(4)) function erff4(vx) vector(real(4)), value :: vx
expd2	expf4	Computes the exponential function of each element of vx.	vector(real(8)) function expd2(vx) vector(real(8)), value :: vx	vector(real(4)) function expf4(vx) vector(real(4)), value :: vx
exp2d2	exp2f4	Computes 2 raised to the power of each element of vx.	vector(real(8)) function exp2d2(vx) vector(real(8)), value :: vx	vector(real(4)) function exp2f4(vx) vector(real(4)), value :: vx
expm1d2	expm1f4	Computes (the exponential function of each element of vx) - 1.	vector(real(8)) function expm1d2(vx) vector(real(8)), value :: vx	vector(real(4)) function exp2m1f4(vx) vector(real(4)), value :: vx
exp2m1d2	exp2m1f4	Computes (2 raised to the power of each element of vx) - 1.	vector(real(8)) function exp2m1d2(vx) vector(real(8)), value :: vx	vector(real(4)) function exp2m1f4(vx) vector(real(4)), value :: vx
hypotd2	hypotf4	For each element of vx and the corresponding element of vy, computes $\sqrt{vx*vx + vy*vy}$.	vector(real(8)) function hypotd2(vx,vy) vector(real(8)), value :: vx, vy	vector(real(4)) function hypotf4(vx,vy) vector(real(4)), value :: vx, vy
lgammad2	lgammaf4	Computes the natural logarithm of the absolute value of the Gamma function of each element of vx .	vector(real(8)) function lgammad2(vx) vector(real(8)), value :: vx	vector(real(4)) function lgammaf4(vx) vector(real(4)), value :: vx
logd2	logf4	Computes the natural logarithm of each element of vx.	vector(real(8)) function logd2(vx) vector(real(8)), value :: vx	vector(real(4)) function logf4(vx) vector(real(4)), value :: vx

Table 16. MASS SIMD functions (continued)

Double-precision function	Single-precision function	Description	Double-precision function interface	Single-precision function interface
log2d2	log2f4	Computes the base-2 logarithm of each element of vx.	vector(real(8)) function log2d2(vx) vector(real(8)), value :: vx	vector(real(4)) function log2f4(vx) vector(real(4)), value :: vx
log10d2	log10f4	Computes the base-10 logarithm of each element of vx.	vector(real(8)) function log10d2(vx) vector(real(8)), value :: vx	vector(real(4)) function log10f4(vx) vector(real(4)), value :: vx
log1pd2	log1pf4	Computes the natural logarithm of each element of (vx + 1).	vector(real(8)) function log1pd2(vx) vector(real(8)), value :: vx	vector(real(4)) function log1pf4(vx) vector(real(4)), value :: vx
log21pd2	log21pf4	Computes the base-2 logarithm of each element of (vx + 1).	vector(real(8)) function log21pd2(vx) vector(real(8)), value :: vx	vector(real(4)) function log21pf4(vx) vector(real(4)), value :: vx
powd2	powf4	Computes each element of vx raised to the power of the corresponding element of vy.	vector(real(8)) function powd2(vx, vy) vector(real(8)), value :: vx, vy	vector(real(4)) function powf4(vx, vy) vector(real(4)), value :: vx, vy
qdrtd2	qdrtf4	Computes the quad root of each element of vx.	vector(real(8)) function qdrtd2(vx) vector(real(8)), value :: vx	vector(real(4)) function qdrtf4(vx) vector(real(4)), value :: vx
rcbrtd2	rcbrtf4	Computes the reciprocal of the cube root of each element of vx.	vector(real(8)) function rcbrtd2(vx) vector(real(8)), value :: vx	vector(real(4)) function rcbrtf4(vx) vector(real(4)), value :: vx
recipd2	recipf4	Computes the reciprocal of each element of vx.	vector(real(8)) function recipd2(vx) vector(real(8)), value :: vx	vector(real(4)) function recipf4(vx) vector(real(4)), value :: vx
rqdrtd2	rqdrtf4	Computes the reciprocal of the quad root of each element of vx.	vector(real(8)) function rqdrtd2(vx) vector(real(8)), value :: vx	vector(real(4)) function rqdrtf4(vx) vector(real(4)), value :: vx
rsqrtd2	rsqrtf4	Computes the reciprocal of the square root of each element of vx.	vector(real(8)) function rsqrtd2(vx) vector(real(8)), value :: vx	vector(real(4)) function rsqrtf4(vx) vector(real(4)), value :: vx

Table 16. MASS SIMD functions (continued)

Double-precision function	Single-precision function	Description	Double-precision function interface	Single-precision function interface
sincosd2	sincosf4	Computes the sine and cosine of each element of vx.	subroutine sincosd2(vx, vs, vc) vector(real(8)), value :: vx vector(real(8)) vs, vc	subroutine sincosf4(vx, vs, vc) vector(real(4)), value :: vx vector(real(4)) vs, vc
sind2	sinf4	Computes the sine of each element of vx.	vector(real(8)) function sind2(vx) vector(real(8)), value :: vx	vector(real(4)) function sinf4(vx) vector(real(4)), value :: vx
sinhd2	sinhf4	Computes the hyperbolic sine of each element of vx.i	vector(real(8)) function sinhd2(vx) vector(real(8)), value :: vx	vector(real(4)) function sinhf4(vx) vector(real(4)), value :: vx
sqrtd2	sqrtof4	Computes the square root of each element of vx.	vector(real(8)) function sqrtd2(vx) vector(real(8)), value :: vx	vector(real(4)) function sqrtof4(vx) vector(real(4)), value :: vx
tand2	tanf4	Computes the tangent of each element of vx.	vector(real(8)) function tand2(vx) vector(real(8)), value :: vx	vector(real(4)) function tanf4(vx) vector(real(4)), value :: vx
tanhd2	tanhf4	Computes the hyperbolic tangent of each element of vx.	vector(real(8)) function tanhd2(vx) vector(real(8)), value :: vx	vector(real(4)) function tanhf4(vx) vector(real(4)), value :: vx

The MASS SIMD library interfaces include the following features:

- The SIMD functions are marked pure. You can call them from pure procedures.
- The intent of the argument is specified to assist in compiler error checking.

The following example shows the XL Fortran interface declarations of some of MASS SIMD library functions:

```

INTERFACE
  PURE VECTOR(REAL*4) FUNCTION acosf4 (x)
    VECTOR(REAL*4), value :: x
  END FUNCTION

  PURE VECTOR(REAL*4) FUNCTION atan2f4 (x,y)
    VECTOR(REAL*4), value :: x,y
  END FUNCTION

  PURE SUBROUTINE sincosf4 (x,s,c)
    VECTOR(REAL*4), value :: x
    VECTOR(REAL*4), INTENT(OUT) :: s,c
  END SUBROUTINE
END INTERFACE

```

Compiling and linking a program with MASS

To compile an application that calls the functions in the following MASS libraries, specify the corresponding library names on the **-l** link option.

Table 17. The scalar, vector, and SIMD MASS library

MASS library	Library name
Scalar library	mass

Table 17. The scalar, vector, and SIMD MASS library (continued)

MASS library	Library name
Vector library	<code>mass_simdp8</code>
SIMD library	<code>massv</code> or <code>massvp8</code>

For example, if the MASS libraries are installed in the default directory, you can use one of the following commands:

Link object file `progf` with scalar library `libmass.a` and vector library `libmassv.a`

```
xlf progf.f -o progf -lmass -lmassv
```

Link object file `progf` with SIMD library `libmass_simdp8.a`

```
xlf progf.f -o progf -lmass_simdp8
```

Using `libmass.a` with the math system library

If you want to use the `libmass.a` scalar library for some functions and the normal math library `libm.a` for other functions, follow this procedure to compile and link your program:

1. Use the `ar` command to extract the object files of the wanted functions from `libmass.a`. For most functions, the object file name is the function name followed by `.s64.o`.¹ For example, to extract the object file for the `tan` function, the command would be:

```
ar -x tan.s64.o libmass.a
```
2. Archive the extracted object files into another library:

```
ar -qv libfasttan.a tan.s64.o
ranlib libfasttan.a
```
3. Create the final executable using `xlf`, specifying `-lfasttan` instead of `-lmass`:

```
xlf sample.f -o sample -Ldir_containing_libfasttan -lfasttan
```

This links only the `tan` function from MASS (now in `libfasttan.a`) and the remainder of the math functions from the standard system library.

Exceptions:

1. The `sin` and `cos` functions are both contained in the object file `sincos.s64.o`. The `cosisin` and `sincos` functions are both contained in the object file `cosisin.s64.o`.
2. The XL Fortran `**` (exponentiation) operator is contained in the object file `dxys64.o`.

Note: The `cos` and `sin` functions will both be exported if either one is exported. `cosisin` and `sincos` will both be exported if either one is exported.

Using the Basic Linear Algebra Subprograms – BLAS

Four Basic Linear Algebra Subprograms (BLAS) functions are shipped with XL Fortran in the `libxlopt` library.

The functions consist of the following:

- `SGEMV` (single-precision) and `DGEMV` (double-precision), which compute the matrix-vector product for a general matrix or its transpose
- `SGEMM` (single-precision) and `DGEMM` (double-precision), which perform combined matrix multiplication and addition for general matrices or their transposes

Note: Some error-handling code has been removed from the BLAS functions in `libxlopt`, and no error messages are emitted for calls to these functions.

“BLAS function syntax” describes the interfaces for the XL Fortran BLAS functions, which are similar to those of the equivalent BLAS functions shipped in IBM's Engineering and Scientific Subroutine Library (ESSL); for more detailed information and examples of usage of these functions, you may want to consult the *Engineering and Scientific Subroutine Library Guide and Reference*, available at the Engineering and Scientific Subroutine Library (ESSL) and Parallel ESSL web page.

“Linking the libxlopt library” on page 78 describes how to link to the XL Fortran `libxlopt` library if you are also using a third-party BLAS library.

BLAS function syntax

The interfaces for the SGEMV and DGEMV functions are as follows:

```
CALL SGEMV(trans, m, n, alpha, a, lda, x, incx, beta, y, incy)
```

```
CALL DGEMV(trans, m, n, alpha, a, lda, x, incx, beta, y, incy)
```

The parameters are as follows:

trans

is a single character indicating the form of the input matrix *a*, where:

- 'N' or 'n' indicates that *a* is to be used in the computation
- 'T' or 't' indicates that the transpose of *a* is to be used in the computation

m represents:

- the number of rows in input matrix *a*
- the length of vector *y*, if 'N' or 'n' is used for the *trans* parameter
- the length of vector *x*, if 'T' or 't' is used for the *trans* parameter

The number of rows must be greater than or equal to zero, and less than or equal to the leading dimension of the matrix *a* (specified in *lda*)

n represents:

- the number of columns in input matrix *a*
- the length of vector *x*, if 'N' or 'n' is used for the *trans* parameter
- the length of vector *y*, if 'T' or 't' is used for the *trans* parameter

The number of columns must be greater than or equal to zero.

alpha

is the scaling constant α

a is the input matrix of single-precision (for SGEMV) or double-precision (for DGEMV) real values

lda

is the leading dimension of the array specified by *a*. The number of rows must be greater than or equal to zero, and less than the leading dimension of the matrix *a* (specified in *lda*).

x is the input vector of single-precision (for SGEMV) or double-precision (for DGEMV) real values.

incx

is the stride for vector *x*. It can have any value.

beta

is the scaling constant β

y is the output vector of single-precision (for SGEMV) or double-precision (for DGEMV) real values.

incy

is the stride for vector *y*. It must not be zero.

Note: Vector *y* must have no common elements with matrix *a* or vector *x*; otherwise, the results are unpredictable.

The prototypes for the SGEMM and DGEMM functions are as follows:

```
CALL SGEMM(transa, transb, l, n, m, alpha, a, lda, b, ldb, beta, c, ldc)
```

```
CALL DGEMM(transa, transb, l, n, m, alpha, a, lda, b, ldb, beta, c, ldc)
```

The parameters are as follows:

transa

is a single character indicating the form of the input matrix *a*, where:

- 'N' or 'n' indicates that *a* is to be used in the computation
- 'T' or 't' indicates that the transpose of *a* is to be used in the computation

transb

is a single character indicating the form of the input matrix *b*, where:

- 'N' or 'n' indicates that *b* is to be used in the computation
- 'T' or 't' indicates that the transpose of *b* is to be used in the computation

l represents the number of rows in output matrix *c*. The number of rows must be less than or equal to the leading dimension of *c*.

n represents the number of columns in output matrix *c*. The number of columns must be greater than or equal to zero.

m represents:

- the number of columns in matrix *a*, if 'N' or 'n' is used for the *transa* parameter
- the number of rows in matrix *a*, if 'T' or 't' is used for the *transa* parameter

and:

- the number of rows in matrix *b*, if 'N' or 'n' is used for the *transb* parameter
- the number of columns in matrix *b*, if 'T' or 't' is used for the *transb* parameter

m must be greater than or equal to zero.

alpha

is the scaling constant α

a is the input matrix *a* of single-precision (for SGEMM) or double-precision (for DGEMM) real values

lda

is the leading dimension of the array specified by *a*. The leading dimension must be greater than zero. If *transa* is specified as 'N' or 'n', the leading dimension must be greater than or equal to 1. If *transa* is specified as 'T' or 't', the leading dimension must be greater than or equal to the value specified in *m*.

b is the input matrix *b* of single-precision (for SGEMM) or double-precision (for DGEMM) real values.

ldb

is the leading dimension of the array specified by *b*. The leading dimension must be greater than zero. If *transb* is specified as 'N' or 'n', the leading dimension must be greater than or equal to the value specified in *m*. If *transa* is specified as 'T' or 't', the leading dimension must be greater than or equal to the value specified in *n*.

beta

is the scaling constant β

c is the output matrix *c* of single-precision (for SGEMM) or double-precision (for DGEMM) real values.

ldc

is the leading dimension of the array specified by *c*. The leading dimension must be greater than zero. If *transb* is specified as 'N' or 'n', the leading dimension must be greater than or equal to the value specified in *l*.

Note: Matrix *c* must have no common elements with matrices *a* or *b*; otherwise, the results are unpredictable.

Linking the libxlopt library

By default, the `libxlopt` library is linked with any application you compile with XL Fortran. However, if you are using a third-party BLAS library, but want to use the BLAS routines shipped with `libxlopt`, you must specify the `libxlopt` library before any other BLAS library on the command line at link time. For example, if your other BLAS library is called `libblas`, you would compile your code with the following command:

```
xlf app.f -lxlopt -lblas
```

The compiler will call the `SGEMV`, `DGEMV`, `SGEMM`, and `DGEMM` functions from the `libxlopt` library, and all other BLAS functions in the `libblas` library.

Chapter 8. Parallel programming with XL Fortran

Parallel programming with XL Fortran involves a combination of compiling, setting of runtime options, and optimization of your code, by incorporating SMP directives and by using the pthreads library module.



XL Fortran supports the OpenMP specification, as understood and interpreted by IBM as well as the POSIX 1003.1-1996 standard.

Note: IBM implementation of OpenMP in XL Fortran is an extension to the standard Fortran language.

Compiling your parallelized code

To compile parallelized code, you must specify the **-qsmp** compiler option. When compiling with **-qsmp**, the driver links the libraries found on the **smplibraries** line in the active stanza of your configuration file.

If you specify **-qsmp**, you must use an appropriate invocation command. Use any of the following invocations to compile SMP code or to ensure that the compiler links threadsafe libraries:

- **xlf_r**
- **xlf90_r**
- **xlf95_r**
- **xlf2003_r**
- **xlf2008_r**
-  **CUDA Fortran** **xlcuf**  **CUDA Fortran**

Related reference:

 See **-qsmp** in the Compiler Reference

The **_OPENMP C** preprocessor macro and conditional compilation

You can use sentinels to mark specific lines of an XL Fortran program for conditional compilation. This allows you to port code that contains statements that are only valid or applicable in an SMP environment to a non-SMP environment. You can do this using conditional compilation lines, or the **_OPENMP C** preprocessor macro. This macro is defined when the C preprocessor is invoked and you specify the **-qsmp=omp** compiler option. See Passing Fortran files through the C preprocessor in the *Editing, Compiling, Linking, and Running XL Fortran Programs* section of the *XL Fortran Compiler Reference* for an example of using this macro.

The following example uses conditional compilation lines to hide OpenMP runtime routines. You cannot easily compile code that calls OpenMP runtime routines in a non-OpenMP environment without using conditional compilation. Since calls to the runtime routines are not directives, they cannot be hidden by the **!\$OMP** trigger. If you do not compile the example with **-qsmp=omp**, the variable that stores the number of threads is assigned the value of 8.

Example of conditional compilation lines

```

PROGRAM PAR_MAT_MUL
!$ USE OMP_LIB
IMPLICIT NONE
INTEGER(KIND=8)                ::I,J,NTHREADS
INTEGER(KIND=8),PARAMETER      ::N=60
INTEGER(KIND=8),DIMENSION(N,N) ::AI,BI,CI
INTEGER(KIND=8)                ::SUMI

COMMON/DATA/ AI,BI,CI
!$OMP THREADPRIVATE (/DATA/)

!$OMP PARALLEL
  FORALL(I=1:N,J=1:N) AI(I,J) = (I-N/2)**2+(J+N/2)
  FORALL(I=1:N,J=1:N) BI(I,J) = 3-((I/2)+(J-N/2)**2)
!$OMP MASTER
  NTHREADS=8
!$  NTHREADS=OMP_GET_NUM_THREADS()
!$OMP END MASTER
!$OMP END PARALLEL

!$OMP PARALLEL DEFAULT(PRIVATE),COPYIN(AI,BI),SHARED(NTHREADS)
!$OMP DO
  DO I=1,NTHREADS
    CALL IMAT_MUL(SUMI)
  ENDDO
!$OMP END DO
!$OMP END PARALLEL

END

```

For information on using sentinels, see Conditional compilation in the *XL Fortran Language Reference*.

Setting runtime options

When you write parallel code, set the necessary XLSMPOPTS environment variables, and the environment variables for OpenMP.

XLSMPOPTS

The **XLSMPOPTS** environment variable allows you to specify options that affect SMP execution. You can declare **XLSMPOPTS** by using the following **bash** command format:

```

▶▶ XLSMPOPTS= [ " ] runtime_option_name = option_setting [ " ] ▶▶

```

You can specify option names and settings in uppercase or lowercase. You can add blanks before and after the colons and equal signs to improve readability. However, if the **XLSMPOPTS** option string contains imbedded blanks, you must enclose the entire option string in double quotation marks (").

You can specify the following runtime options with the **XLSMPOPTS** environment variable:

Scheduling options

When the SMP run time is used to divide the iteration space of a loop through auto-parallelization, a scheduling algorithm is used to assign iterations to the threads in the parallel region. Each thread receives and executes a contiguous

range of iterations, which is called a block or a chunk. Threads might finish their blocks of work at different speeds. After completing the assigned work, threads can be assigned more work or go to sleep. The chunk size can be controlled in some algorithms; doing so is a trade-off between overhead and load balancing.

Note: Use the `OMP_SCHEDULE` environment variable for loops that are explicitly assigned to runtime schedule type with the **OpenMP** schedule clause.

schedule=static[=*n*]

The iteration space is divided into blocks of *n* contiguous iterations. The final block might have fewer than *n* iterations. If *n* is unspecified, its default value is $\text{FLOOR}(\text{number_of_iterations} / \text{number_of_threads})$. The first $\text{REMAINDER}(\text{number_of_iterations} / \text{number_of_threads})$ chunks have one more iteration. Each thread is assigned a separate chunk.

The blocks are assigned in a round-robin fashion to threads in the parallel region until there are no remaining blocks. A thread that completes all its blocks goes to sleep. This is also known as block-cyclic scheduling, or cyclic scheduling when *n* has the value 1.

schedule=dynamic[=*n*]

The iteration space is divided into chunks that contain *n* contiguous iterations each. The final chunk might contain fewer than *n* iterations. If *n* is not specified, the chunk contains one iteration.

Each thread is initially assigned one chunk. After threads complete their assigned chunks, they are assigned remaining chunks on a "first-come, first-do" basis.

schedule=affinity[=*n*]

The iteration space is divided into number-of-thread-in-parallel-region partitions. Each partition has $\text{CEILING}(\text{number-of-iterations} / \text{number-of-thread-in-parallel-region})$ contiguous iterations. The final partition might have fewer iterations. The partitions are further divided into blocks, each with *n* iterations. If *n* is unspecified, its default value is $\text{CEILING}(\text{number-of-iterations-in-partition} / 2)$; that is, each partition is divided into two blocks.

Each thread is assigned a partition. Each thread completes blocks within its local partition until no blocks remain in its partition. If blocks remain in other partitions, but a thread completes all blocks in its local partition, the thread might complete blocks in another thread's partition. A thread goes to sleep if it completes its blocks and no blocks remain.

Note: This option has been deprecated and might be removed in a future release. Instead, you can use the **guided** option.

schedule=guided[=*n*]

The iteration space is divided into blocks of successively smaller size. Each block is sized to the larger of *n* and $\text{CEILING}(\text{number-of-iterations-remaining} / \text{number-of-thread-in-parallel-region})$. The final chunk might contain fewer than *n* iterations. If *n* is unspecified, its default value is 1.

Each thread is initially assigned one block. As threads complete their work, they are assigned remaining blocks on a "first-come, first-serve" basis. A thread goes to sleep if it completes its blocks and no blocks remain.

schedule=auto

The compiler and runtime might select any algorithm to assign work to threads. A different algorithm might be selected for different loops. In addition, a different algorithm might be selected if the run time is updated.

The **OMP_SCHEDULE** environment variable affects only the constructs with a **schedule(runtime)** clause specified.

Parallel execution options

parthds=num

Specifies the number of threads (*num*) to be used for parallel execution of code that you compiled with the **-qsmp** option. By default, this is equal to the number of online processors. There are some applications that cannot use more than some maximum number of processors. There are also some applications that can achieve performance gains if they use more threads than there are processors.

This option allows you full control over the number of execution threads. The default value for *num* is 1 if you did not specify **-qsmp**. Otherwise, it is the number of online processors on the machine. For more information, see the **NUM_PARTHDS** intrinsic function in the *XL Fortran Language Reference*.

Note: This option has been deprecated and might be removed in a future release.

usrthds=num

Specifies the maximum number of threads (*num*) that you expect your code will explicitly create if the code does explicit thread creation. The default value for *num* is 0. For more information, see the **NUM_PARTHDS** intrinsic function in the *XL Fortran Language Reference*.

Note: This option has been deprecated and might be removed in a future release.

stack=num

Specifies the largest amount of space in bytes (*num*) that a thread's stack will need. The default value for *num* is 4194304.

Set **stack=num** so it is within the acceptable upper limit. *num* can be up to the limit imposed by system resources or the stack size ulimit, whichever is smaller. An application that exceeds the upper limit may cause a segmentation fault.

Note: This option has been deprecated and might be removed in a future release. Instead, you can use the **OMP_STACKSIZE** environment variable.

stackcheck[=num]

Enables stack overflow checking for worker threads at runtime. *num* is the size in bytes that you specify, and it must be a nonnull positive number. When the remaining stack size is less than *num*, a runtime

warning message is issued. If you do not specify a value for *num*, the default value is 4096 bytes. Note that this option only has an effect when **-qsmp=stackcheck** has also been specified at compile time. See **-qsmp** in the *XL Fortran Compiler Reference* for more information.

startproc=cpu_id

Enables thread binding and specifies the *cpu_id* to which the first thread binds. If the value provided is outside the range of available processors, the SMP run time issues a warning message and no threads are bound.

Note: This option has been deprecated and might be removed in a future release. Instead, you can use the **OMP_PLACES** environment variable.

procs=cpu_id[,cpu_id,...]

Enables thread binding and specifies a list of *cpu_id* to which the threads are bound.

Note: This option has been deprecated and might be removed in a future release. Instead, you can use the **OMP_PLACES** environment variable.

stride=num

Specifies the increment used to determine the *cpu_id* to which subsequent threads bind. *num* must be greater than or equal to 1. If the value provided causes a thread to bind to a CPU outside the range of available processors, a warning message is issued and no threads are bound.

Note: This option has been deprecated and might be removed in a future release. Instead, you can use the **OMP_PLACES** environment variable.

Performance tuning options

When a thread completes its work and there is no new work to do, it can go into either a "busy-wait" state or a "sleep" state. In "busy-wait", the thread keeps executing in a tight loop looking for additional new work. This state is highly responsive but harms the overall utilization of the system. When a thread sleeps, it completely suspends execution until another thread signals it that there is work to do. This state provides better utilization of the system but introduces extra overhead for the application.

The **xlsmp** runtime library routines use both "busy-wait" and "sleep" states in their approach to waiting for work. You can control these states with the **spins**, **yields**, and **delays** options.

During the busy-wait search for work, the thread repeatedly scans the work queue up to *num* times, where *num* is the value that you specified for the option **spins**. If a thread cannot find work during a given scan, it intentionally wastes cycles in a delay loop that executes *num* times, where *num* is the value that you specified for the option **delays**. This delay loop consists of a single meaningless iteration. The length of actual time this takes will vary among processors. If the value **spins** is exceeded and the thread still cannot find work, the thread will yield the current time slice (time allocated by the processor to that thread) to the other threads. The thread will yield its time slice up to *num* times, where *num* is the number that you specified for the option **yields**. If this value *num* is exceeded, the thread will go to sleep.

In summary, the ordered approach to looking for work consists of the following steps:

1. Scan the work queue for up to **spins** number of times. If no work is found in a scan, then loop **delays** number of times before starting a new scan.
2. If work has not been found, then yield the current time slice.
3. Repeat the above steps up to **yields** number of times.
4. If work has still not been found, then go to sleep.

The syntax for specifying these options is as follows:

spins[=*num*]

where *num* is the number of spins before a yield. The default value for **spins** is **100**.

yields[=*num*]

where *num* is the number of yields before a sleep. The default value for **yields** is **10**.

delays[=*num*]

where *num* is the number of delays while busy-waiting. The default value for **delays** is **500**.

Zero is a special value for **spins** and **yields**, as it can be used to force complete busy-waiting. Normally, in a benchmark test on a dedicated system, you would set both options to zero. However, you can set them individually to achieve other effects.

For instance, on a dedicated 8-way SMP, setting these options to the following:

```
parthds=8 : schedule=dynamic=10 : spins=0 : yields=0
```

results in one thread per CPU, with each thread assigned chunks consisting of 10 iterations each, with busy-waiting when there is no immediate work to do.

Options to enable and control dynamic profiling

You can use dynamic profiling to reevaluate the compiler's decision to parallelize loops in a program. The three options you can use to do this are: **parthreshold**, **seqthreshold**, and **profilefreq**.

parthreshold=*num*

Specifies the time, in milliseconds, below which each loop must execute serially. If you set **parthreshold** to 0, every loop that has been parallelized by the compiler will execute in parallel. The default setting is 0.2 milliseconds, meaning that if a loop requires fewer than 0.2 milliseconds to execute in parallel, it should be serialized.

Typically, **parthreshold** is set to be equal to the parallelization overhead. If the computation in a parallelized loop is very small and the time taken to execute these loops is spent primarily in the setting up of parallelization, these loops should be executed sequentially for better performance.

seqthreshold=*num*

Specifies the time, in milliseconds, beyond which a loop that was previously serialized by the dynamic profiler should revert to being a parallel loop. The default setting is 5 milliseconds, meaning that if a loop requires more than 5 milliseconds to execute serially, it should be parallelized.

seqthreshold acts as the reverse of **parthreshold**.

profilefreq=num

Specifies the frequency with which a loop should be revisited by the dynamic profiler to determine its appropriateness for parallel or serial execution. Loops in a program can be data dependent. The loop that was chosen to execute serially with a pass of dynamic profiling may benefit from parallelization in subsequent executions of the loop, due to different data input. Therefore, you need to examine these loops periodically to reevaluate the decision to serialize a parallel loop at run time.

The allowed values for this option are the numbers from 0 to 32. If you set **profilefreq** to one of these values, the following results will occur.

- If **profilefreq** is 0, all profiling is turned off, regardless of other settings. The overheads that occur because of profiling will not be present.
- If **profilefreq** is 1, loops parallelized automatically by the compiler will be monitored every time they are executed.
- If **profilefreq** is 2, loops parallelized automatically by the compiler will be monitored every other time they are executed.
- If **profilefreq** is greater than or equal to 2 but less than or equal to 32, each loop will be monitored once every *n*th time it is executed.
- If **profilefreq** is greater than 32, then 32 is assumed.

It is important to note that dynamic profiling is not applicable to user-specified parallel loops (for example, loops for which you specified the **PARALLEL DO** directive).

Related information:

“OMP_PLACES” on page 91

“OMP_STACKSIZE” on page 97

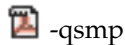

Environment variables for OpenMP

The following environment variables, which are included in the OpenMP standard, allow you to control the execution of parallel code.

Note: If you specify both the **XL SMP_OPTS** environment variable and an OpenMP environment variable, the OpenMP environment variable takes precedence.

OMP_DISPLAY_ENV

When a program that uses the OpenMP runtime library is invoked and the **OMP_DISPLAY_ENV** environment variable is set, the OpenMP runtime library displays the values of the internal control variables (ICVs) associated with the environment variables and the build-specific information about the runtime library.

OMP_DISPLAY_ENV is useful in the following cases:

- When the runtime library is statically linked with an OpenMP program, you can use **OMP_DISPLAY_ENV** to check the version of the library that is used during link time.
- When the runtime library is dynamically linked with an OpenMP program, you can use **OMP_DISPLAY_ENV** to check the library that is used at run time.
- You can use **OMP_DISPLAY_ENV** to check the current setting of the runtime environment.

By default, no information is displayed.

The syntax of this environment variable is as follows:



Note: The values **TRUE**, **FALSE**, **VERBOSE** are not case-sensitive.

TRUE

Displays the OpenMP version number defined by the `_OPENMP` macro and the initial ICV values for the OpenMP environment variables.

FALSE

Instructs the runtime environment not to display any information.

VERBOSE

Displays build-specific information, ICV values associated with OpenMP environment variables, and the setting of the **XLSMPOPTS** environment variable.

Usage

When **OMP_DISPLAY_ENV** is **TRUE**, the initial ICV values for the OpenMP environment variables are displayed. If **OMP_PLACES** is set to **cores** or **threads**, the **OMP_PLACES** value is displayed in the format of **cores** or **threads** followed by the number of places in brackets; for example, **OMP_PLACES='cores(4)'**. For custom **OMP_PLACES**, each resource is displayed individually in each place, followed by the keyword **custom**; for example, **OMP_PLACES='{4,5,6,7},{8,9,10,11}' custom**.

When **OMP_DISPLAY_ENV** is **VERBOSE**, the output includes a section that is delineated by the lines `OPENMP DISPLAY AFFINITY BEGIN` and `OPENMP DISPLAY AFFINITY END`. This section includes a verbose display of the **OMP_PLACES** value, where each resource for each place is displayed individually, followed by **cores**, **threads**, or **custom** as appropriate. This section also displays information on **THREADS_PER_PLACE** in the format of a comma-separated list of the individual **THREADS_PER_PLACE** value for each place; for example, **THREADS_PER_PLACE='{2},{2}'**.

Examples

Example 1

If you enter the **export OMP_DISPLAY_ENV=TRUE** command, you get output similar to the following example:

```
OPENMP DISPLAY ENVIRONMENT BEGIN
  OMP_DISPLAY_ENV='TRUE'

  _OPENMP='201107'
  OMP_DYNAMIC='FALSE'
  OMP_MAX_ACTIVE_LEVELS='5'
  OMP_NESTED='FALSE'
  OMP_NUM_THREADS='96'
  OMP_PROC_BIND='FALSE'
  OMP_SCHEDULE='STATIC,0'
```

```
OMP_STACKSIZE='4194304'
OMP_THREAD_LIMIT='96'
OMP_WAIT_POLICY='PASSIVE'
OPENMP_DISPLAY_ENVIRONMENT END
```

Example 2

If you enter the **export OMP_DISPLAY_ENV=VERBOSE** command, you will get output that is similar to the following example:

```
OPENMP_DISPLAY_AFFINITY_BEGIN
OMP_PLACES='{0},{1},{2},{3},{4},{5},{6},{7},{8},{9},{10}' cores
THREADS_PER_PLACE='{1},{1},{1},{1},{1},{1},{1},{1},{1},{1},{1}'
OPENMP_DISPLAY_AFFINITY_END
```

Related information

“XLSMPOPTS” on page 80

“OMP_PLACES” on page 91

“OMP_PROC_BIND” on page 92

OMP_DYNAMIC

The **OMP_DYNAMIC** environment variable controls dynamic adjustment of the number of threads available for the execution of parallel regions.

►► OMP_DYNAMIC = TRUE / FALSE ◀◀

When **OMP_DYNAMIC** is set to **TRUE**, the number of threads that are created and then assigned to a place must not exceed the value of **THREADS_PER_PLACE**. The thread number includes the currently allocated threads of all active parallel regions. Under a given **OMP_PROC_BIND** policy, **THREADS_PER_PLACE** takes precedence in all situations.

When **OMP_DYNAMIC** is set to **FALSE**, if an application requires more threads than the value of **THREADS_PER_PLACE** in any place under a given **OMP_PROC_BIND** policy, the excess threads beyond the value of **THREADS_PER_PLACE** for all such places are assigned with priority to the following places:

1. Places that have not reached **THREADS_PER_PLACE**.
2. Places where the master thread is not running.

Examples

Example 1

Suppose **OMP_THREAD_LIMIT=48** and **OMP_PLACES={0,1,2,3,4,5,6,7},{8,9,10,11,12,13,14,15},{16,17,18,19}**, the **THREADS_PER_PLACE** values are calculated as follows:

$P_0 = \{0,1,2,3,4,5,6,7\}$: size = 8, total size = 20, **THREADS_PER_PLACE** = $\text{floor}((8/20)*48) = \text{floor}(19.2) = 19$

P1={8,9,10,11,12,13,14,15}: size = 8, total size = 20, **THREADS_PER_PLACE** = $\text{floor}((8/20)*48) = \text{floor}(19.2) = 19$

P2={16,17,18,19}: size = 4, total size = 20, **THREADS_PER_PLACE** = $\text{floor}((4/20)*48) = \text{floor}(9.6) = 9$

The number of total allocated threads is 47. Threads are allocated by place size. Because P0 and P1 have the same largest size and P0 comes first in **OMP_PLACES**, threads are allocated starting with P0. The thread allocation order is: P0, P1, P2. Only one thread is unallocated, so it is allocated to P0. Therefore, **THREADS_PER_PLACE**={20},{19},{9}.

Example 2

Suppose **OMP_THREAD_LIMIT**=17 and **OMP_PLACES**={0,1,2,3,0,1,2,3},{4,5,6,7},{8,9,10,11}, the **THREADS_PER_PLACE** values are calculated as follows:

P0={0,1,2,3,0,1,2,3}: size = 8, total size = 16, **THREADS_PER_PLACE** = $\text{floor}((8/16)*17) = \text{floor}(8.5) = 8$

P1={4,5,6,7}: size = 4, total size = 16, **THREADS_PER_PLACE** = $\text{floor}((4/16)*17) = \text{floor}(4.25) = 4$

P2={8,9,10,11}: size = 4, total size = 16, **THREADS_PER_PLACE** = $\text{floor}((4/16)*17) = \text{floor}(4.25) = 4$

The number of total allocated threads is 16. Threads are allocated by place size, so the thread allocation order is: P0, P1, P2. Only one thread is unallocated, so it is allocated to P0. Therefore, **THREADS_PER_PLACE**={9},{4},{4}.

Example 3

Suppose **OMP_THREAD_LIMIT**=394 and **OMP_PLACES**={0,1},{2,3,4,5},{6,7,8,9,10,11},{12,13,14,15},{16,17,18,19,20,21,22,23}, the **THREADS_PER_PLACE** values are calculated as follows:

P0={0,1}: size = 2, total size = 24, **THREADS_PER_PLACE** = $\text{floor}((2/24)*394) = \text{floor}(32.8) = 32$

P1={2,3,4,5}: size = 4, total size = 24, **THREADS_PER_PLACE** = $\text{floor}((4/24)*394) = \text{floor}(65.7) = 65$

P2={6,7,8,9,10,11}: size = 6, total size = 24, **THREADS_PER_PLACE** = $\text{floor}((6/24)*394) = \text{floor}(98.5) = 98$

P3={12,13,14,15}: size = 4, total size = 24, **THREADS_PER_PLACE** = $\text{floor}((4/24)*394) = \text{floor}(65.7) = 65$

P4={16,17,18,19,20,21,22,23}: size = 8, total size = 24, **THREADS_PER_PLACE** = $\text{floor}((8/24)*394) = \text{floor}(131.3) = 131$

The number of total allocated threads is 391. Threads are allocated by place size, so the thread allocation order is: P4, P2, P1, P3, P0. Three threads are unallocated, so the **THREADS_PER_PLACE** values of P4, P2, and P1 are increased by one each. Therefore, **THREADS_PER_PLACE**={32},{66},{99},{65},{132}.

Related information

“OMP_PLACES” on page 91

“OMP_PROC_BIND” on page 92

OMP_MAX_ACTIVE_LEVELS

The **OMP_MAX_ACTIVE_LEVELS** environment variable controls the maximum number of nested active parallel regions. The syntax is as follows:

```
▶▶—OMP_MAX_ACTIVE_LEVELS=n————▶▶
```

n is the maximum number of nested active parallel regions. It must be a positive scalar integer. The maximum number that you can specify is 5.

OMP_NESTED

The **OMP_NESTED** environment variable enables or disables nested parallelism. The syntax is as follows:

```
▶▶—OMP_NESTED=

|       |
|-------|
| FALSE |
| TRUE  |

————▶▶
```

If you set this environment variable to **TRUE**, nested parallelism is enabled, which means that the runtime environment might deploy extra threads to form the team of threads for the nested parallel region. If you set this environment variable to **FALSE**, nested parallelism is disabled, which means nested parallel regions are serialized and run in the current thread.

The default value for **OMP_NESTED** is **FALSE**.

The setting of the **omp_set_nested** subroutine overrides the **OMP_NESTED** setting.

Note: If the number of threads from all regions exceeds the number of available processors, your program might suffer performance degradation.

OMP_NUM_THREADS

The **OMP_NUM_THREADS** environment variable sets the number of threads to use for parallel regions. The syntax of the environment variable is as follows:

```
▶▶—OMP_NUM_THREADS=num_list————▶▶
```

num_list

A list of one or more positive integer values separated by commas.

If you do not set the **OMP_NUM_THREADS** environment variable, the number of processors available is the default value to form a new team for the first encountered parallel construct. By default, any nested constructs are run by one thread.

If *num_list* contains a single value, dynamic adjustment of the number of threads is enabled (**OMP_DYNAMIC** is set to true), a parallel construct without a

NUM_THREADS clause is encountered, the value is the maximum number of threads that can be used to form a new team for the encountered parallel construct.

If *num_list* contains a single value, dynamic adjustment of the number of threads is not enabled (**OMP_DYNAMIC** is set to false), a parallel construct without a **NUM_THREADS** clause is encountered, the value is the exact number of threads that can be used to form a new team for the encountered parallel construct.

If *num_list* contains multiple values, dynamic adjustment of the number of threads is enabled (**OMP_DYNAMIC** is set to true), a parallel construct without a **NUM_THREADS** clause is encountered, the first value is the maximum number of threads that can be used to form a new team for the encountered parallel construct. After the encountered construct is entered, the first value is removed and the remaining values form a new *num_list*. The new *num_list* is in turn used in the same way for any closely nested parallel constructs inside the encountered parallel construct.

If *num_list* contains multiple values, dynamic adjustment of the number of threads is not enabled (**OMP_DYNAMIC** is set to false), a parallel construct without a **NUM_THREADS** clause is encountered, the first value is the exact number of threads that can be used to form a new team for the encountered parallel construct. After the encountered construct is entered, the first value is removed and the remaining values form a new *num_list*. The new *num_list* is in turn used in the same way for any closely nested parallel constructs inside the encountered parallel construct.

Note: If the number of parallel regions is equal to or greater than the number of values in *num_list*, the **omp_get_max_threads** routine returns the last value of *num_list* in the parallel region.

If the number of threads requested exceeds the system resources available, the program stops.

The **omp_set_num_threads** routine sets the first value of *num_list*. The **omp_get_max_threads** routine returns the first value of *num_list*.

If you specify the number of threads for a given parallel region more than once with different settings, the compiler uses the following precedence order to determine which setting takes effect:

1. The number of threads set using the **NUM_THREADS** clause takes precedence over that set using the **omp_set_num_threads** routine.
2. The number of threads set using the **omp_set_num_threads** routine takes precedence over that set using the **OMP_NUM_THREADS** environment variable.
3. The number of threads set using the **OMP_NUM_THREADS** environment variable takes precedence over that set using the **PARTHDS** suboption of the **XLSMPOPTS** environment variable.

Note: The **PARTHDS** suboption of the **XLSMPOPTS** environment variable is deprecated.

Note: In a given parallel region, the **omp_get_max_threads** routine returns the first value of *num_list*, even though the actual number of threads running that parallel region might be different from the first value of *num_list*.

The following example shows how you can set the `OMP_NUM_THREADS` environment variable.

```
export OMP_NUM_THREADS=5,10
export OMP_DYNAMIC=false

! OMP_GET_MAX_THREADS() returns 5 threads
!$omp parallel
! OMP_GET_MAX_THREADS() returns 10 threads
!$omp parallel
! OMP_GET_MAX_THREADS() returns 10 threads
!$omp parallel
! OMP_GET_MAX_THREADS() returns 10 threads
!$omp end parallel
!$omp end parallel
!$omp end parallel
```

OMP_PLACES

The `OMP_PLACES` environment variable specifies a list of places that are available when the OpenMP program is executed. The value of `OMP_PLACES` can be either one of the following values:

- An abstract name that describes a set of places
- An explicit list of places that are described by non-negative numbers

OMP_PLACES syntax

►► `OMP_PLACES=` *place_list* *place_name* ◄◄

where *place_list* takes one of the following syntax forms:

place_list syntax: form 1

►► , ! { *lower_bound* : *length* : *stride* } ◄◄
num

place_list syntax: form 2

►► ! { *lower_bound* : *length* } : *num_places* : *multiplier* ◄◄

where *lower_bound*, *length*, *stride*, *num*, *num_places*, and *multiplier* are positive integers that represent the units of execution that are exposed to the execution environment. The thread number in each place starts with the value that is a multiple of *multiplier*. An exclusion operator `!` excludes the number or place that follows the operator immediately.

place_name syntax

►► *cores* *threads* (*num_places*) ◄◄

threads

Each place contains a hardware thread.

cores Each place contains a core. If **OMP_PLACES** is not set, the default setting is **cores**.

num_places

Is the number of places.

Usage

When requested places are fewer than that are available on the system, the execution environment assigns places in the order of the place list at run time. When requested places are more than that are available on the system, the execution environment assigns the maximum number of places that the system supports at run time.

For a program that contains both OpenMP and OpenMPI code, the OpenMP runtime detects the existence of OpenMPI code by the presence of the **OMPI_COMM_WORLD_RANK** environment variable. If you do not set **OMP_PLACES** explicitly, the compiler sets **OMP_PLACES** to **cores** and removes any unavailable resources from **OMP_PLACES** based on the OpenMPI affinity policy. In addition, **OMP_PROC_BIND** is set to **TRUE**.

For examples on how to set the **OMP_PLACES** environment variable, see examples in **OMP_PROC_BIND**.

OMP_PROC_BIND

The **OMP_PROC_BIND** environment variable controls the thread affinity policy and whether OpenMP threads can be moved between places. With the thread affinity feature, you can have a fine-grained control of how threads are bound and distributed to places. Three thread affinity policies exist: **MASTER**, **CLOSE**, and **SPREAD**.

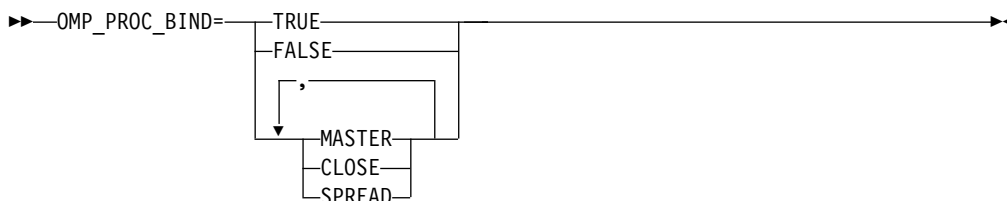
OMP_PROC_BIND syntax**TRUE**

Binds the threads to places.

FALSE

Allows threads to be moved between places and disables thread affinity.

MASTER

Instructs the execution environment to assign the threads in the team to the same place as the master thread.

CLOSE

Instructs the execution environment to assign the threads in the team to the places that are close to the place of the parent thread. The place partition is not changed by this policy. Each implicit task inherits the *place-partition-var* ICV of

the parent implicit task. Suppose T threads in the team are assigned to P places in the parent's place partition, the threads are assigned as follows:

- If T is less than or equal to P , the master thread executes on the place of the parent thread. The thread with the next smallest thread number executes on the next place in the place partition, and so on, with wrap around with respect to the place partition of the master thread.
- If T is greater than P , each place contains at least $S = \text{floor}(T/P)$ consecutive threads. The first S threads with the smallest thread number (including the master thread) are assigned to the place of the parent thread. The next S threads with the next smallest thread numbers are assigned to the next place in the place partition, and so on, with wrap around with respect to the place partition of the master thread. When P does not divide T evenly, each remaining thread is assigned to a subpartition in the order of the place list.

SPREAD

Instructs the execution environment to spread a set of T threads as evenly as possible among P places of the parent's place partition at run time. The thread distribution mechanism is as follows:

- If T is less than or equal to P , the parent partition is divided into T subpartitions, where each subpartition contains at least $S = \text{floor}(P/T)$ consecutive places. A single thread is assigned to each subpartition. The master thread executes on the place of the parent thread and is assigned to the subpartition that includes that place. The thread with the next smallest thread number is assigned to the first place in the next subpartition, and so on, with wrap around with respect to the original place partition of the master thread.
- If T is greater than P , the parent's partition is divided into P subpartitions, where each subpartition contains a single place. Each place contains at least $S = \text{floor}(T/P)$ consecutive threads. The first S threads with the smallest thread number (including the master thread) are assigned to the subpartition that contains the place of the parent thread. The next S threads with the next smallest thread numbers are assigned to the next place in the place partition, and so on, with wrap around with respect to the original place partition of the master thread. When P does not divide T evenly, each remaining thread is assigned to a subpartition in the order of the place list.

where,

Place

is a hardware unit that holds an unordered set of processors on which one or more threads can execute.

Place list

is an ordered list that describes all places that are available to the applications.

Place partition

is an ordered list that corresponds to a contiguous interval in the place list. The places in the partition are available for a given parallel region.

When **OMP_PROC_BIND** is set to **TRUE**, **MASTER**, **CLOSE**, or **SPREAD**, a place can be assigned with up to **THREADS_PER_PLACE** threads. Each remaining thread is assigned to a place in the order of the place list.

For each place in **OMP_PLACES**, **THREADS_PER_PLACE** is a positive integer and is calculated in the following way:

$THREADS_PER_PLACE = \text{floor}(\frac{\text{the number of resources in that place}}{\text{the total number of resources (including duplicated resources)}} * OMP_THREAD_LIMIT)$

After `THREADS_PER_PLACE` is calculated for each place in this manner, if the sum of all the `THREADS_PER_PLACE` values is less than `OMP_THREAD_LIMIT`, each `THREADS_PER_PLACE` is increased by one, starting from the largest place to the smallest place, until `OMP_THREAD_LIMIT` is reached. Places that are equivalent in size are ordered according to their order in `OMP_PLACES`.

Usage

By default, the `OMP_PROC_BIND` environment variable is not set.

If the initial thread cannot be bound to the first place in the OpenMP place list, the runtime execution environment issues a message and assigns threads according to the default place list.

The `OMP_PROC_BIND` and `XLSMPOPTS` environment variables interact with each other according to the following rules:

Table 18. Thread binding rule summary

OMP_PROC_BIND settings	XLSMPOPTS settings	Thread binding results
OMP_PROC_BIND is not set	XLSMPOPTS is not set	Threads are not bound.
	XLSMPOPTS is set to startproc/stride or procs ²	Threads are bound according to the settings in XLSMPOPTS .
	XLSMPOPTS setting is invalid	Threads are not bound.
OMP_PROC_BIND = TRUE	XLSMPOPTS is not set	Threads are bound.
	XLSMPOPTS is set to startproc/stride or procs ²	Threads are bound according to the settings in XLSMPOPTS ¹ .
	XLSMPOPTS setting is invalid	Threads are bound.
OMP_PROC_BIND = FALSE	XLSMPOPTS is not set	Threads are not bound.
	XLSMPOPTS is set (startproc/stride or procs ²)	
	XLSMPOPTS setting is invalid	
Note:		
1. If procs is set and the number of CPU IDs specified is smaller than the number of threads that are used by the program, the remaining threads are also bound to the listed CPU IDs but not in any particular order. If XLSMPOPTS=startproc is used, the value specified by startproc is smaller than the number of CPUs, and the value that is specified by stride causes a thread to bind to a CPU outside the range of available places, some of the threads are bound and some are not.		
2. The startproc/stride and procs suboptions of XLSMPOPTS are deprecated.		

The `OMP_PROC_BIND` environment variable provides a portable way to control whether OpenMP threads can be migrated. The **startproc/stride** or **procs** suboption of the `XLSMPOPTS` environment variable, which is an IBM extension, provides a finer control to bind OpenMP threads to places. If portability of your application is important, use only the `OMP_PROC_BIND` environment variable to control thread binding.

When `OMP_PROC_BIND` is set to `MASTER`, `CLOSE`, or `SPREAD`, the suboption settings `startproc/stride` or `procs` of `XLSMPOPTS` are ignored.

For a program that contains both OpenMP and OpenMPI code, the OpenMP runtime detects the existence of OpenMPI code by the presence of the `OMPI_COMM_WORLD_RANK` environment variable. If you do not set `OMP_PLACES` explicitly, the compiler sets `OMP_PROC_BIND` to be `TRUE`.

Examples

The following examples demonstrate the thread binding and thread affinity results when you compile `myprogram.f` with different environment variable settings.

`myprogram.f`

```
PROGRAM MYPROGRAM
  !... ..
END PROGRAM MYPROGRAM
```

Environment variable settings 1

```
OMP_NUM_THREADS=4;
OMP_PROC_BIND=MASTER;
OMP_PLACES='{0:4},{4:4},{8:4},{12:4},{16:4},{20:4},{24:4},{28:4}'
```

Results 1: Every thread in the team is assigned to the place on which the master executes. Four threads are assigned to place 0.

Environment variable settings 2

```
OMP_NUM_THREADS=4;
OMP_PROC_BIND=close;
OMP_PLACES='{0:4},{4:4},{8:4},{12:4},{16:4},{20:4},{24:4},{28:4}'
```

Results 2: The thread is assigned to a place that is close to the place of the parent thread. The thread assignment is as follows:

- OMP thread 0 is assigned to place 0
- OMP thread 1 is assigned to place 1
- OMP thread 2 is assigned to place 2
- OMP thread 3 is assigned to place 3

Environment variable settings 3

```
OMP_NUM_THREADS=4;
OMP_PROC_BIND=spread;
OMP_PLACES='{0:4},{4:4},{8:4},{12:4},{16:4},{20:4},{24:4},{28:4}'
```

Results 3: The number of threads 4 is smaller than the number of places 8, so four subpartitions are formed. 8 is evenly divided by 4, so the thread assignment is as follows:

- OMP thread 0 is assigned to place 0
- OMP thread 1 is assigned to place 2
- OMP thread 2 is assigned to place 4
- OMP thread 3 is assigned to place 6

Environment variable settings 4

```
OMP_NUM_THREADS=5;
OMP_PROC_BIND=spread;
OMP_PLACES='{0:4},{4:4},{8:4},{12:4},{16:4},{20:4},{24:4},{28:4}'
```

Results 4: The number of threads 5 is smaller than the number of places 8, so five subpartitions are formed. 8 is not evenly divided by 5, so threads are assigned to the places in order. The thread assignment is as follows:

- OMP thread 0 is assigned to place 0
- OMP thread 1 is assigned to place 2
- OMP thread 2 is assigned to place 4
- OMP thread 3 is assigned to place 6
- OMP thread 4 is assigned to place 7

Environment variable settings 5

```
OMP_NUM_THREADS=8;
OMP_PROC_BIND=spread;
OMP_PLACES='{0:4},{4:4},{8:4},{12:4}'
```

Results 5: The number of threads 8 is greater than the number of places 4, so four subpartitions are formed. 8 is evenly divided by 4, so two threads are assigned to each subpartition. The thread assignment is as follows:

- OMP thread 0 and thread 1 are assigned to place 0
- OMP thread 2 and thread 3 are assigned to place 1
- OMP thread 4 and thread 5 are assigned to place 2
- OMP thread 6 and thread 7 are assigned to place 3

Environment variable settings 6

```
OMP_NUM_THREADS=7;
OMP_PROC_BIND=spread;
OMP_PLACES='{0:4},{4:4},{8:4},{12:4}'
```

Results 6: The number of threads 7 is greater than the number of places 4, so four subpartitions are formed. 7 is not evenly divided by 4, so one thread ($\text{floor}(7/4)=1$) is assigned to each subpartition. The thread assignment is as follows:

- OMP thread 0 is assigned to place 0
- OMP thread 1 and thread 2 are assigned to place 1
- OMP thread 3 and thread 4 are assigned to place 2
- OMP thread 5 and thread 6 are assigned to place 3

Related reference:

- “PROC_BIND” on page 171
- “omp_get_proc_bind()” on page 190

Related information:

- “XLSMPOPTS” on page 80
- “OMP_PLACES” on page 91

OMP_SCHEDULE

The **OMP_SCHEDULE** environment variable applies to the **PARALLEL DO** and work-sharing **DO** directives that have a schedule type of **RUNTIME**. The syntax is as follows:

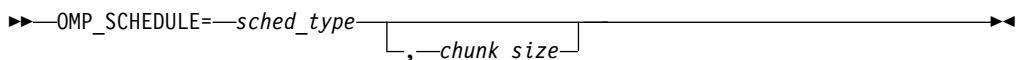

sched_type

is either **AUTO**, **DYNAMIC**, **GUIDED**, or **STATIC**. See the “**SCHEDULE**” on page 175 clause for a description of these scheduling parameters.

chunk_size

is a positive, scalar integer that represents the chunk size.

This environment variable is ignored for the **PARALLEL DO** and work-sharing **DO** directives that have a schedule type other than **RUNTIME**.

If you do not specify a schedule type either at compile time through a directive, or at run time through the **OMP_SCHEDULE** environment variable or the **SCHEDULE** option of the **XLSMPOPTS** environment variable, the default schedule type is **AUTO**, which delegates scheduling decision to the compiler and runtime system. You cannot specify *chunk_size* when the schedule type is set to **AUTO**.

If you specify both the **SCHEDULE** option of the **XLSMPOPTS** environment variable and the **OMP_SCHEDULE** environment variable, the **OMP_SCHEDULE** environment variable takes precedence.

The following examples show how you can set the **OMP_SCHEDULE** environment variable:

```
export OMP_SCHEDULE="DYNAMIC"  
export OMP_SCHEDULE="GUIDED,4"  
export OMP_SCHEDULE="STATIC"  
export OMP_SCHEDULE="AUTO"
```

OMP_STACKSIZE

The **OMP_STACKSIZE** environment variable specifies the size of the stack for threads created by the OpenMP run time. The syntax is as follows:

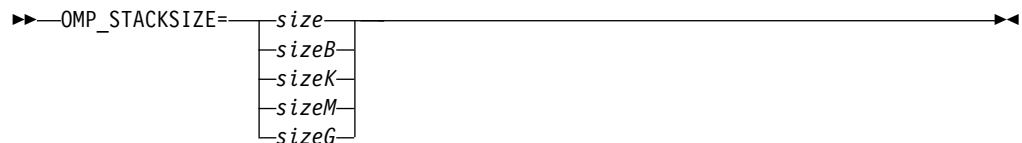

size is a positive integer that specifies the size of the stack for threads that are created by the OpenMP run time.

"B", "K", "M", "G"

are letters that specify whether the given size is in Bytes, Kilobytes, Megabytes, or Gigabytes.

If only *size* is specified and none of *"B", "K", "M", "G"* is specified, *size* is in Kilobytes by default. This environment variable does not control the size of the stack for the initial thread.

The value assigned to the **OMP_STACKSIZE** environment variable is case insensitive and might have leading and trailing white space. The following examples show how you can set the **OMP_STACKSIZE** environment variable.

```
export OMP_STACKSIZE="10M"  
export OMP_STACKSIZE=" 10 M "
```

If the value of **OMP_STACKSIZE** is not set, the initial value is set to the default value. (up to the limit that is imposed by system resources).

If the compiler cannot deliver the stack size specified by the environment variable, or if `OMP_STACKSIZE` does not conform to the valid format, the compiler sets the environment variable to the default value.

The `OMP_STACKSIZE` environment variable takes precedence over the `stack` suboption of the `XLSPMPOPTS` environment variable.

OMP_THREAD_LIMIT

The `OMP_THREAD_LIMIT` environment variable sets the number of OpenMP threads to use for the whole program. The syntax is as follows:

►►—OMP_THREAD_LIMIT—=—*n*—————►►

n The number of OpenMP threads to use for the whole program. It must be a positive scalar integer that is less than 65536.

Usage

When `OMP_THREAD_LIMIT=1`, the parallel regions are run sequentially rather than in parallel. However, when `OMP_THREAD_LIMIT` is much smaller than the number of threads that are required in the program, the parallel region might still run in parallel but with less number of threads. When there are nested parallel regions, some parallel regions might run in parallel, some might run sequentially, and some might run in parallel but with threads that are recycled from other regions.

If `OMP_THREAD_LIMIT` is not defined and `OMP_NESTED=TRUE`, the default value of `OMP_THREAD_LIMIT` is the greater value of either the multiplication of all `OMP_NUM_THREADS` levels or the number of total resources in `OMP_PLACES`.

If `OMP_THREAD_LIMIT` is not defined and `OMP_NESTED=FALSE`, the default value of `OMP_THREAD_LIMIT` is the greater value of either the first level of `OMP_NUM_THREADS` or the number of total resources in `OMP_PLACES`.

If neither `OMP_THREAD_LIMIT` nor `OMP_NESTED` is defined, the default value of `OMP_THREAD_LIMIT` is the number of total resources in `OMP_PLACES`.

Examples

Suppose `OMP_THREAD_LIMIT` is not defined and `OMP_PLACES={0,1,2,3,4,5,6,7},{8,9,10,11,12,13,14,15}`. The number of total resources in `OMP_PLACES` is 16.

Example 1

When `OMP_NESTED=TRUE` and `OMP_NUM_THREADS=2,12`, the default value of `OMP_THREAD_LIMIT` is 24, because the multiplication of all `OMP_NUM_THREADS` levels is 24 and 24 is greater than 16.

Example 2

When `OMP_NESTED=FALSE` and `OMP_NUM_THREADS=2,4`, the default value of `OMP_THREAD_LIMIT` is 16, because the first level of `OMP_NUM_THREADS` is 2 and 16 is greater than 2.

Related information

“OMP_PLACES” on page 91

“OMP_NUM_THREADS” on page 89

“OMP_NESTED” on page 89

OMP_WAIT_POLICY

The **OMP_WAIT_POLICY** environment variable provides hints about the preferred behavior of waiting threads during program execution. The syntax is as follows:

```
▶▶—OMP_WAIT_POLICY={PASSIVE|ACTIVE}—▶▶
```

Use **ACTIVE** if you want waiting threads to mostly be active. That is, the threads consume processor cycles while waiting. For example, waiting threads can spin while waiting. The **ACTIVE** wait policy is recommended for maximum performance on the dedicated machine.

Use **PASSIVE** if you want waiting threads to mostly be passive. That is, the threads do not consume processor cycles while waiting. For example, waiting threads can sleep or yield the processor to other threads.

The default value of **OMP_WAIT_POLICY** is **PASSIVE**.

Note: If you set the **OMP_WAIT_POLICY** environment variable and specify the **SPINS**, **YIELDS**, or **DELAYS** suboptions of the **XLSPMPOPTS** environment variable, **OMP_WAIT_POLICY** takes precedence.

Optimizing your SMP code

Most IBM processors are capable of shared-memory parallel processing. Compile with **-qsmp** to generate the threaded code needed to exploit this capability. The option implies a **-O2** optimization level. The default behavior for the option without suboptions is to do automatic parallelization with optimization.

The most commonly used **-qsmp** suboptions are summarized in the following table.

Commonly used **-qsmp** suboptions

Suboption	Behavior
auto	Instructs the compiler to automatically generate parallel code where possible without user assistance. This option also recognizes all the SMP directives.
omp	Enforces compliance with the OpenMP API for specifying explicit parallelism.
opt	Instructs the compiler to optimize as well as parallelize. The optimization is equivalent to -O2 -qhot in the absence of other optimization options. The default setting of -qsmp is -qsmp=auto:noomp:opt .
suboptions	Other values for the suboption provide control over thread scheduling, nested parallelism, locking, and so on.

Developing and running SMP applications

- By default, the parallelization performed is both user-directed and automatic. Use `-qsmp=omp:noauto` if you are compiling an OpenMP program and do not want automatic parallelization.
- Before using `-qsmp` with automatic parallelization, test your programs using optimization and `-qhot` in a single-threaded manner.
- Always use the reentrant compiler invocations (the `_r` command invocations, like `xlfr_r`) when using `-qsmp`.
- By default, the run time uses all available processors. Do not set the `XLSMPOPTS=PARTHDS` or `OMP_NUM_THREADS` variables unless you want to use fewer than the number of available processors. You might want to set the number of executing threads to a small number or to 1 to ease debugging.

Note: The `XLSMPOPTS=PARTHDS` variable is deprecated.

- If you are using a dedicated machine or node, consider setting `OMP_WAIT_POLICY` to `ACTIVE` or setting the `SPINS` and `YIELDS` variables (suboptions of `XLSMPOPTS`) to 0. Doing so prevents the operating system from intervening in the scheduling of threads across synchronization boundaries such as barriers.
- When debugging an SMP program, try using `-qsmp=noopt` (without `-O`) to make the debugging information produced by the compiler more precise. You can also use the `SNAPSHOT` directive to create additional program points for storage visibility by flushing registers to memory.

An introduction to parallelization directives

These directives allow you to exert control over parallelization. For example, the `PARALLEL DO` directive specifies that the loop immediately following the directive should be run in parallel. All parallelization directives are comment form directives.

For more information on rules and syntax for comment form directives, see Comment and noncomment form directives in the *XL Fortran Language Reference*.

XL Fortran supports a number of SMP directives, divided as follows. To ensure the greatest portability of code, OpenMP directives are recommended where possible. Use the OpenMP *trigger_constant*, `$OMP` for OpenMP directives, but do not use this *trigger_constant* with any other directive. OpenMP directives must not appear in `PURE` and `ELEMENTAL` procedures.

Parallel region construct

Parallel constructs form the foundation of OpenMP based parallel execution in XL Fortran. The `PARALLEL/END PARALLEL` directive pair forms a basic parallel construct. Each time an executing thread enters a parallel region, it creates a team of threads and becomes master of that team. This allows parallel execution to take place within that construct by the threads in that team. The following directives are necessary for a parallel region:

<code>PARALLEL</code>	<code>END PARALLEL</code>
-----------------------	---------------------------

Work-sharing constructs

Work-sharing constructs divide the execution of code enclosed by the construct between threads in a team. For work-sharing to take place, the construct must be

enclosed within the dynamic extent of a parallel region. For further information on work-sharing constructs, see the following directives:

DO	END DO
SECTIONS	END SECTIONS
WORKSHARE	END WORKSHARE
SINGLE	END SINGLE

Combined parallel work-sharing constructs

A combined parallel work-sharing construct allows you to specify a parallel region that already contains a single work-sharing construct. These combined constructs are semantically identical to specifying a parallel construct enclosing a single work-sharing construct. For more information on implementing combined constructs, see the following directives:

PARALLEL DO	END PARALLEL DO
PARALLEL SECTIONS	END PARALLEL SECTIONS
PARALLEL WORKSHARE	END PARALLEL WORKSHARE

Synchronization constructs

The following directives allow you to synchronize the execution of a parallel region by multiple threads in a team:

ATOMIC	
BARRIER	
CRITICAL	END CRITICAL
FLUSH	
ORDERED	END ORDERED
TASKWAIT	

Other OpenMP directives

The following OpenMP directives provide additional SMP functionality:

MASTER	END MASTER
TASK	END TASK
THREADPRIVATE	

Non-OpenMP SMP directives

The following directives provide additional SMP functionality:

DO SERIAL	THREADLOCAL
SCHEDULE	

Deprecated directive

The SMP directive listed in the following table has been deprecated and might be removed in a future release. Use the corresponding OpenMP directive or clause to obtain the same behavior.

Table 19. Deprecated SMP directive

SMP directive name	OpenMP directive/clause name
SCHEDULE	SCHEDULE

The following example shows how to replace the deprecated SMP **SCHEDULE** directive with the OpenMP **SCHEDULE** clause.

The original code that uses the SMP **SCHEDULE** directive is as follows:

```
program loop
  integer, parameter :: N=500
  integer :: i
!SMP$ SCHEDULE(STATIC)
  real :: arr(N)

!SMP$ parallel do
  do i=1, N
    arr(i) = real(i-1)
  enddo
end program
```

To obtain the same behavior, you can use the OpenMP **SCHEDULE** clause, as shown below:

```
program loop
  integer, parameter :: N=500
  integer :: i
  real :: arr(N)

!$OMP parallel do schedule(static)
  do i=1, N
    arr(i) = real(i-1)
  enddo
end program
```

Detailed descriptions of parallelization directives

This section lists, in alphabetical order, all parallelization directives supported by XL Fortran.

For information about directive clauses, see “Directive clauses” on page 155.

ATOMIC

Purpose

You can use the **ATOMIC** directive to access a specific memory location safely within a parallel region. When you use the **ATOMIC** directive, the compiler generates code to ensure that only one thread is accessing the memory location at a time to avoid errors that might occur from simultaneous reads or writes to the same memory location.

Atomic operations are useful when you create multithreaded or concurrent algorithms and data structures. Using atomic constructs, you can write more efficient concurrent algorithms with fewer locks.

An atomic construct supports the following kinds of atomic access:

- Atomic update
Updates the value of a variable atomically. Allows only one thread to write to a shared variable at a time, avoiding errors from simultaneous writes to the same variable.
- Atomic read
Reads the value of a variable atomically. The value of a shared variable can be read safely, avoiding the danger of reading an intermediate value of the variable when it is accessed simultaneously by a concurrent thread.
- Atomic write
Writes the value of a variable atomically. The value of a shared variable can be written exclusively to avoid errors from simultaneous writes.
- Atomic capture
Updates the value of a variable while capturing the original or final value of the variable atomically.

The **ATOMIC** directive takes effect only if you specify the **-qsmp** compiler option.

Note: The atomic operations are not interoperable between V15.1.1 and V15.1.2. The atomic implementation of V15.1.2 is more efficient.

Syntax

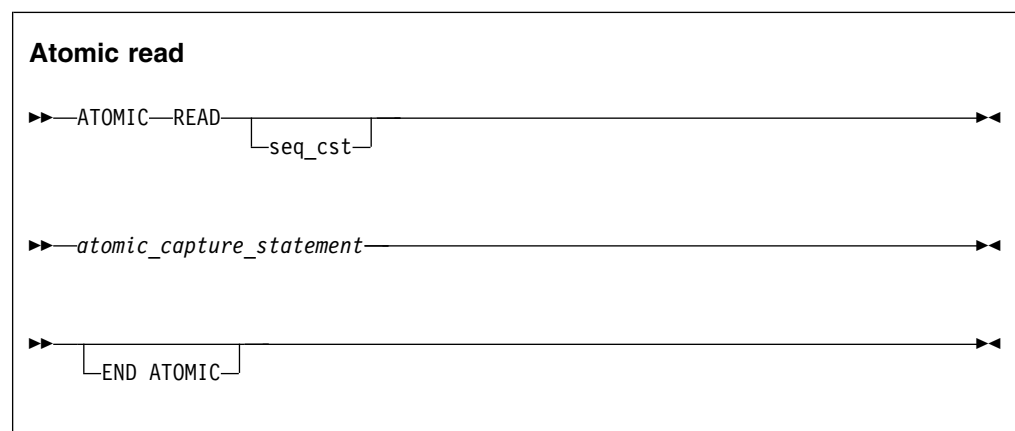
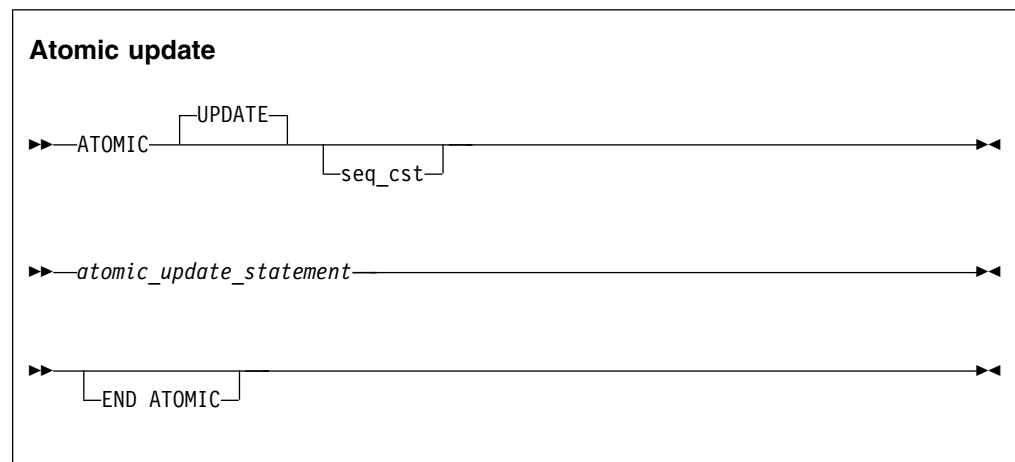

Atomic write

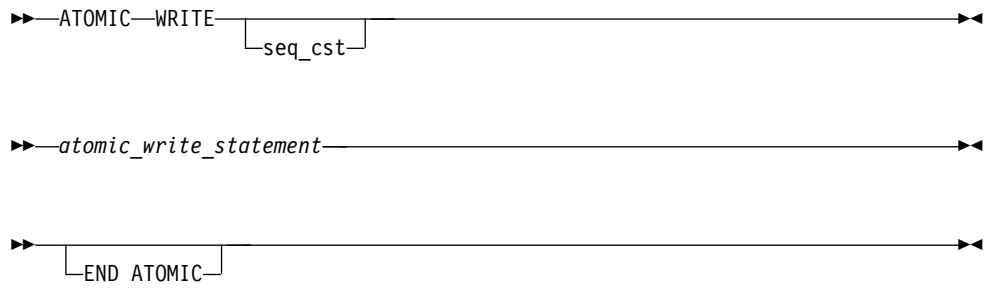

Atomic capture

```
▶▶ ATOMIC CAPTURE [seq_cst] _____▶▶
```

```
▶▶ atomic_update_statement _____▶▶
```

```
▶▶ atomic_capture_statement _____▶▶
```

```
▶▶ END ATOMIC _____▶▶
```

Or

```
▶▶ ATOMIC CAPTURE [seq_cst] _____▶▶
```

```
▶▶ atomic_capture_statement _____▶▶
```

```
▶▶ atomic_update_statement _____▶▶
```

```
▶▶ END ATOMIC _____▶▶
```

Or

```
▶▶ ATOMIC CAPTURE [seq_cst] _____▶▶
```

```
▶▶ atomic_capture_statement _____▶▶
```

```
▶▶ atomic_write_statement _____▶▶
```

```
▶▶ END ATOMIC _____▶▶
```

Note: The last form is to support atomic swap operations.

where:

atomic_update_statement
is one of the following forms:

update_variable = *update_variable* operator *expression*
update_variable = *expression* operator *update_variable*
update_variable = *intrinsic*(*update_variable*, *expression_list*)
update_variable = *intrinsic*(*expression_list*, *update_variable*)

atomic_write_statement

has the following form:

update_variable = *expression*

atomic_capture_statement

has the following form:

capture_variable = *update_variable*

seq_cst

is a clause that supports sequentially atomic operations. It forces atomically performed operations to include an implicit flush operation without a list.

where:

update_variable, *capture_variable*

are both nonpointer, nonallocatable scalar variables of intrinsic type.

intrinsic

is one of **MAX**, **MIN**, **IAND**, **IOR** or **IEOR**.

operator

is one of **+**, **-**, *****, **/**, **.AND.**, **.OR.**, **.EQV.**, **.NEQV.** or **.XOR.**

expression

is a scalar expression that does not reference *update_variable*.

expression_list

is a comma-separated, non-empty list of scalar expressions that do not reference *update_variable*.

Note: If the intrinsic is **IAND**, **IOR**, or **IEOR**, *expression_list* can only contain one expression.

Rules

An **ATOMIC** directive without a clause is equivalent to atomic update, and applies only to the statement that immediately follows it.

All accesses to a certain storage location throughout a concurrent program must be atomic. A non-atomic access to a memory location might break the expected atomic behavior of all atomic accesses to that storage location.

The *expression* in an atomic statement is not evaluated atomically. You must ensure that no race conditions exist in the calculation.

Within the entire program, if you use the **ATOMIC** directive to make references to the storage location of an *update_variable*, all these references must have the same type and type parameters.

capture_variable, *expression*, and *expression_list* must not access the same storage location as *update_variable*.

For atomic capture access, the operation of writing the captured value to the storage location represented by *capture_variable* is not atomic.

The function *intrinsic*, the operator *operator*, and the assignment must be the intrinsic function, operator and assignment, and not a redefined intrinsic function, defined operator or defined assignment.

Examples

Example 1: In this example, multiple threads are updating a counter. **ATOMIC** is used to ensure that no updates are lost.

```
PROGRAM P
  R = 0.0
  !$OMP PARALLEL DO SHARED(R)
    DO I = 1, 10
  !$OMP ATOMIC
    R = R + 1.0
  END DO
  PRINT *,R
END PROGRAM P
```

Expected output:

10.0

Example 2: In this example, an **ATOMIC** directive is required, because it is uncertain which element of array Y is updated in each iteration.

```
PROGRAM P
  INTEGER, DIMENSION(10) :: Y, INDEX
  INTEGER B

  Y = 5
  READ(*,*) INDEX, B
  !$OMP PARALLEL DO SHARED(Y)
    DO I = 1, 10
  !$OMP ATOMIC
    Y(INDEX(I)) = MIN(Y(INDEX(I)),B)
  END DO
  PRINT *, Y
END PROGRAM P
```

Input data:

10 10 8 8 6 6 4 4 2 2 4

Expected output:

5 4 5 4 5 4 5 4 5 4

Example 3: This example demonstrates the usage of atomic capture.

```
FUNCTION fnc(upper) RESULT(ret)
  INTEGER, INTENT(IN) :: upper
  INTEGER :: ret
  INTEGER, SAVE :: iter = 0

  !$OMP ATOMIC CAPTURE
    iter = iter + 1
    ret = iter
  !$OMP END ATOMIC

  IF (ret .GT. upper) THEN
    ret = -1
  ENDIF
END FUNCTION fnc
```

Related reference:

“CRITICAL / END CRITICAL” on page 109

“PARALLEL / END PARALLEL” on page 121

 See `-qsmp` in the Compiler Reference

BARRIER

Purpose

The **BARRIER** directive enables you to synchronize all threads of a team. When a thread encounters a **BARRIER** directive, it will not execute beyond the **BARRIER** until all other threads in the team complete all explicit tasks in the region.

Type

The **BARRIER** directive only takes effect if you specify the `-qsmp` compiler option.

Syntax

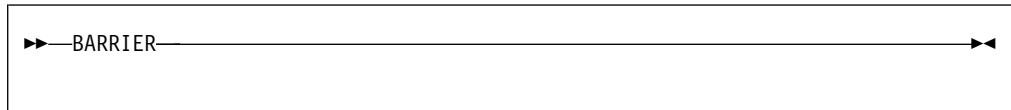

Rules

A **BARRIER** region binds to the closest enclosing **PARALLEL** region.

A **BARRIER** region must not be closely nested inside a **CRITICAL**, **MASTER**, **ORDERED**, **TASK** or work-sharing region.

All threads of the team which are executing the binding parallel region must execute the **BARRIER** region, and they must not continue execution beyond the **BARRIER** until they complete execution of all explicit tasks that are bound to this parallel region.

All **BARRIER** regions and work-sharing region must be encountered in the same order by all threads in the team.

Each **BARRIER** region must be encountered by all threads in a team or by none at all.

In addition to synchronizing the threads in a team, the **BARRIER** directive implies the **FLUSH** directive without the *variable_name_list*.

Examples

An example of the **BARRIER** construct binding to the **PARALLEL** construct. Note: To calculate *C*, we need to ensure that *A* and *B* have been completely assigned to, so threads need to wait.

```
SUBROUTINE SUB1
  INTEGER A(1000), B(1000), C(1000)
!$OMP PARALLEL
!$OMP DO
  DO I = 1, 1000
    A(I) = SIN(I*2.5)
  END DO
!$OMP END DO NOWAIT
!$OMP DO
```

```

        DO J = 1, 10000
          B(J) = X + COS(J*5.5)
        END DO
!$OMP END DO NOWAIT
        ...
!$OMP BARRIER
        C = A + B
!$OMP END PARALLEL
        END

```

Related reference:

“FLUSH” on page 115

“PARALLEL / END PARALLEL” on page 121



See `-qsmp` in the Compiler Reference

CRITICAL / END CRITICAL

Purpose

The **CRITICAL** construct allows you to define independent blocks of code that are to be run by at most one thread at a time. It includes a **CRITICAL** directive that is followed by a block of code and ends with an **END CRITICAL** directive.

Type

The **CRITICAL** and **END CRITICAL** directives only take effect if you specify the `-qsmp` compiler option.

Syntax

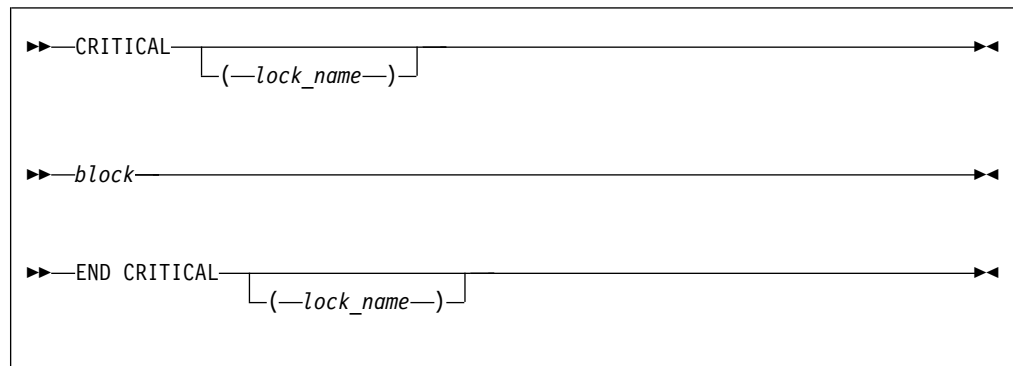

lock_name

provides a way of distinguishing different **CRITICAL** constructs of code.

block

represents the block of code to be executed by at most one thread at a time.

Rules

The optional *lock_name* is a name with global scope. You must not use the *lock_name* to identify any other global entity in the same executable program.

If you specify the *lock_name* on the **CRITICAL** directive, you must specify the same *lock_name* on the corresponding **END CRITICAL** directive.

If you specify the same *lock_name* for more than one **CRITICAL** construct, the compiler will allow only one thread to execute any one of these **CRITICAL** constructs at any one time. **CRITICAL** constructs that have different *lock_names* may be run in parallel.

The same lock protects all **CRITICAL** constructs that do not have an explicit *lock_name*. In other words, the compiler will assign the same *lock_name*, thereby ensuring that only one thread enters any unnamed **CRITICAL** construct at a time.

The *lock_name* must not share the same name as any local entity of Class 1.

It is illegal to branch into or out of a **CRITICAL** construct.

The **CRITICAL** construct may appear anywhere in a program.

Although it is possible to nest a **CRITICAL** construct within a **CRITICAL** region, a deadlock situation may result. The `-qsmp=rec_locks` compiler option can be used to prevent deadlocks. See the *XL Fortran Compiler Reference* for more information. The OpenMP API does not allow nested **CRITICAL** regions to have the same name.

CRITICAL and **END CRITICAL** directives imply the **FLUSH** directive without the *variable_name_list*.

 A **CYCLE** statement must not appear within a **CRITICAL** construct if it belongs to an outer construct.

An **EXIT** statement must not appear within a **CRITICAL** construct if it belongs to that construct or an outer construct. 

Examples

Example 1: This example illustrates the use of a **CRITICAL** construct to update a shared variable inside a parallel region. The **CRITICAL** construct restricts only one thread to execute the code at a time.

```
      EXPR=0
!$OMP PARALLEL DO PRIVATE (I)
      DO I = 1, 100
!$OMP   CRITICAL
          EXPR = EXPR + A(I) * I
!$OMP   END CRITICAL
      END DO
```

Example 2: An example specifying a *lock_name* on the **CRITICAL** construct.

```
!$OMP PARALLEL DO PRIVATE(T)
      DO I = 1, 100
          T = B(I) * B(I-1)
!$OMP   CRITICAL (LOCK)
          SUM = SUM + T
!$OMP   END CRITICAL (LOCK)
      END DO
```

Related reference:

“**ATOMIC**” on page 102

“**FLUSH**” on page 115



See Global entity in the Language Reference

 See Local entity in the Language Reference
“PARALLEL / END PARALLEL” on page 121

 See -qsmp in the Compiler Reference

DO / END DO

Purpose

The **DO** (work-sharing) construct enables you to divide the execution of the loop among the members of the team that encounter it. The **END DO** directive enables you to indicate the end of a **DO** loop that is specified by the **DO** (work-sharing) directive.

The **DO** (work-sharing) and **END DO** directives only take effect when you specify the **-qsmp** compiler option.

Syntax

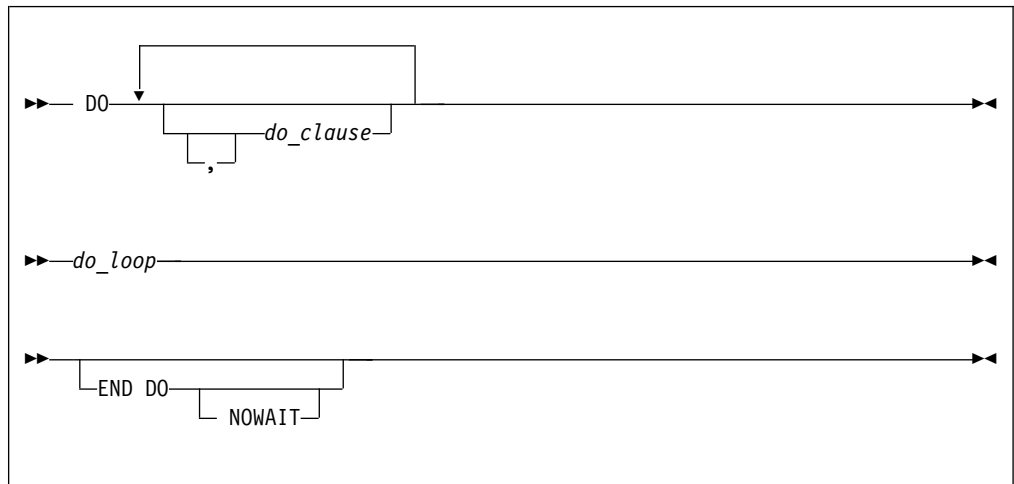

where *do_clause* is:



collapse_clause

See — “COLLAPSE” on page 156.

firstprivate_clause

See — “FIRSTPRIVATE” on page 163.

lastprivate_clause

See — “LASTPRIVATE” on page 165.

ordered_clause

See — “ORDERED” on page 168

private_clause

See — “PRIVATE” on page 169.

reduction_clause

See — “REDUCTION” on page 172

schedule_clause

See — “SCHEDULE” on page 175

Rules

The first noncomment line (not including other directives) that follows the **DO** (work-sharing) directive must be a **DO** loop. This line cannot be an infinite **DO** or **DO WHILE** loop. The **DO** (work-sharing) directive applies only to the **DO** loop that is immediately following the directive, and not to any nested **DO** loops, unless the **COLLAPSE** clause is specified.

The **END DO** directive is optional. If you use the **END DO** directive, it must immediately follow the end of the **DO** loop.

You may have a **DO** construct that contains several **DO** statements. If the **DO** statements share the same **DO** termination statement, and an **END DO** directive follows the construct, you can only specify a work-sharing **DO** directive for the outermost **DO** statement of the construct.

If you specify **NOWAIT** on the **END DO** directive, a thread that completes its iterations of the loop early will proceed to the instructions following the loop. The thread will not wait for the other threads of the team to complete the **DO** loop. If you do not specify **NOWAIT** on the **END DO** directive, each thread will wait for all other threads within the same team at the end of the **DO** loop.

If you do not specify the **NOWAIT** clause, the **END DO** directive implies the **FLUSH** directive without the *variable_name_list*.

All threads in the team must encounter the **DO** (work-sharing) directive if any thread encounters it. A **DO** loop must have the same loop boundary and step value for each thread in the team. All work-sharing constructs and **BARRIER** directives that are encountered must be encountered in the same order by all threads in the team.

A **DO** (work-sharing) directive must not appear within a **CRITICAL**, **MASTER**, or **ORDERED** region. In addition, it must not appear within a work-sharing region or a **TASK** region unless it is bound to another parallel region.

You cannot follow a **DO** (work-sharing) directive by another **DO** (work-sharing) directive. You can only specify one **DO** (work-sharing) directive for a given **DO** loop.

The **DO** (work-sharing) directive cannot appear with either an **INDEPENDENT** or **DO SERIAL** directive for a given **DO** loop.

To ensure that the same assignment of logical iteration numbers to threads is used in two work-sharing loop regions, you can use the **STATIC** schedule of the **SCHEDULE** clause. For details, see “SCHEDULE” on page 175.

Examples

Example 1: An example of several independent **DO** loops within a **PARALLEL** construct. No synchronization is performed after the first work-sharing **DO** loop, because **NOWAIT** is specified on the **END DO** directive.

```
!$OMP PARALLEL
!$OMP DO
    DO I = 2, N
        B(I) = (A(I) + A(I-1)) / 2.0
    END DO
!$OMP END DO NOWAIT
!$OMP DO
    DO J = 2, N
        C(J) = SQRT(REAL(J*J))
    END DO
!$OMP END DO
    C(5) = C(5) + 10
!$OMP END PARALLEL
END
```

Example 2: An example of **SHARED**, and **SCHEDULE** clauses.

```
!$OMP PARALLEL SHARED(A)
!$OMP DO SCHEDULE(STATIC,10)
    DO I = 1, 1000
        A(I) = I * 4
    END DO
!$OMP END DO
!$OMP END PARALLEL
```

Example 3: An example of both a **MASTER** and a **DO** (work-sharing) directive that bind to the closest enclosing **PARALLEL** directive.

```
!$OMP PARALLEL DEFAULT(PRIVATE), SHARED(X)
    Y = 100
!$OMP MASTER
    PRINT *, Y
!$OMP END MASTER
!$OMP DO
    DO I = 1, 10
        X(I) = I
        X(I) = X(I) + Y
    END DO
!$OMP END PARALLEL
END
```

Example 4: An example of both the **FIRSTPRIVATE** and the **LASTPRIVATE** clauses on **DO** (work-sharing) directives.

```
    X = 100

!$OMP PARALLEL PRIVATE(I), SHARED(X,Y)
!$OMP DO FIRSTPRIVATE(X), LASTPRIVATE(X)
    DO I = 1, 80
        Y(I) = X + I
        X = I
    END DO
!$OMP END PARALLEL
END
```

Related reference:

“COLLAPSE” on page 156



See **DO** in the Language Reference

“**DO SERIAL**” on page 114

“FLUSH” on page 115



See INDEPENDENT in the Language Reference

“ORDERED / END ORDERED” on page 119

“PARALLEL / END PARALLEL” on page 121

“PARALLEL DO / END PARALLEL DO” on page 123

DO SERIAL

Purpose

The **DO SERIAL** directive indicates to the compiler that the **DO** loop that is immediately following the directive must not be parallelized. This directive is useful in blocking automatic parallelization for a particular **DO** loop. The **DO SERIAL** directive only takes effect if you specify the **-qsmp** compiler option.

Syntax

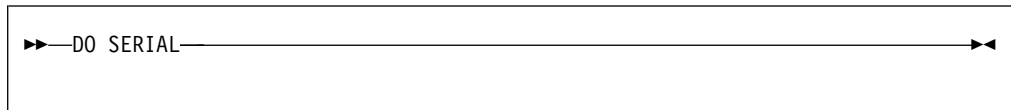

Rules

The first noncomment line (not including other directives) that is following the **DO SERIAL** directive must be a **DO** loop. The **DO SERIAL** directive applies only to the **DO** loop that immediately follows the directive and not to any loops that are nested within that loop.

You can only specify one **DO SERIAL** directive for a given **DO** loop. The **DO SERIAL** directive must not appear with the **DO** (work-sharing), or **PARALLEL DO** directive on the same **DO** loop.

White space is optional between **DO** and **SERIAL**.

You should not use the OpenMP trigger constant with this directive.

Examples

Example 1: An example with nested **DO** loops where the inner loop (the **J** loop) is not parallelized.

```
!$OMP PARALLEL DO PRIVATE(S,I), SHARED(A)
  DO I=1, 500
    S=0
    !SMP$ DOSERIAL
    DO J=1, 500
      S=S+1
    ENDDO
    A(I)=S+I
  ENDDO
```

Example 2: An example with the **DOSERIAL** directive applied in nested loops. In this case, if automatic parallelization is enabled the **I** or **K** loop may be parallelized.

```

      DO I=1, 100
!SMP$ DOSERIAL
      DO J=1, 100
        DO K=1, 100
          ARR(I,J,K)=I+J+K
        ENDDO
      ENDDO
    ENDDO

```

Related reference:

“DO / END DO” on page 111



See DO in the Language Reference

“PARALLEL DO / END PARALLEL DO” on page 123



See -qdirective in the Compiler Reference



See -qsmp in the Compiler Reference

FLUSH

Purpose

The **FLUSH** directive ensures that each thread has access to data generated by other threads. This directive is required because the compiler may keep values in processor registers if a program is optimized. The **FLUSH** directive ensures that the memory images that each thread views are consistent.

The **FLUSH** directive only takes effect if you specify the **-qsmp** compiler option.

You might be able to improve the performance of your program by using the **FLUSH** directive instead of the **VOLATILE** attribute. The **VOLATILE** attribute causes variables to be flushed after every update and before every use, while **FLUSH** causes variables to be written to or read from memory only when specified.

Syntax

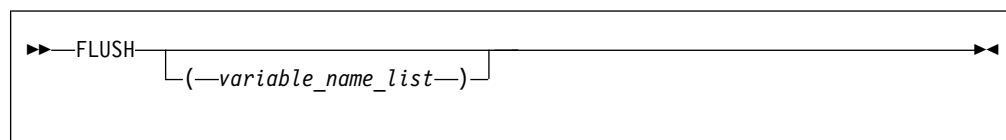

Rules

You can specify this directive anywhere in your code; however, if you specify it outside a parallel region, it is ignored.

If you specify a *variable_name_list*, only the variables in that list are written to or read from memory (assuming that they have not been written or read already). All variables in the *variable_name_list* must be at the current scope and must be thread visible. Thread visible variables can be any of the following:

- Globally visible variables (common blocks and module data)
- Local and host-associated variables with the **SAVE** attribute
- Local variables without the **SAVE** attribute that are specified in a **SHARED** clause in a parallel region within the subprogram

- Local variables without the **SAVE** attribute that have had their addresses taken
- All pointer dereferences
- Dummy arguments

If an item or a subobject of an item in the *variable_name_list* has the **POINTER** attribute, the allocation and association status of the **POINTER** item is flushed, but the pointer target is not.

If an item in the *variable_name_list* is an integer pointer, the pointer is flushed, but the object to which it points is not.

If an item in the *variable_name_list* has the **ALLOCATABLE** attribute and the item is allocated, the allocated object is flushed; otherwise, the allocation status is flushed.

If an item in the *variable_name_list* is of type **C_PTR**, the variable is flushed, but the storage that corresponds to that address is not flushed.

If you do not specify a *variable_name_list*, all thread visible variables are written to or read from memory.

When a thread encounters the **FLUSH** directive, it writes into memory the modifications to the affected variables. The thread also reads the latest copies of the variables from memory if it has local copies of those variables: for example, if it has copies of the variables in registers.

It is not mandatory for all threads in a team to use the **FLUSH** directive. However, to guarantee that all thread visible variables are current, any thread that modifies a thread visible variable should use the **FLUSH** directive to update the value of that variable in memory. If you do not use **FLUSH** or one of the directives that implies **FLUSH** (see below), the value of the variable might not be the most recent one.

The **FLUSH** directive does not imply any ordering between the directive and operations on variables not in the *variable_name_list*. The **FLUSH** directive does not imply any ordering between two or more **FLUSH** constructs if the constructs do not have any variables in common in the *variable_name_list*.

Note that **FLUSH** is not atomic. You must **FLUSH** shared variables that are controlled by a shared lock variable with one directive and then **FLUSH** the lock variable with another. This guarantees that the shared variables are written before the lock variable.

The following directives imply a **FLUSH** directive without the *variable_name_list* unless you specify a **NOWAIT** clause for those directives to which it applies:

- **BARRIER**
- **CRITICAL/END CRITICAL**
- **END DO**
- **END SECTIONS**
- **END SINGLE**
- **END WORKSHARE**
- **PARALLEL/END PARALLEL**
- **PARALLEL DO/END PARALLEL DO**
- **PARALLEL SECTIONS/END PARALLEL SECTIONS**

- **PARALLEL WORKSHARE/END PARALLEL WORKSHARE**
- **ORDERED/END ORDERED**

The **ATOMIC** directive implies a **FLUSH** directive with the *variable_name_list*. The *variable_name_list* contains only the object updated in the **ATOMIC** construct

The following routines imply a **FLUSH** directive without the *variable_name_list*:

- During **OMP_SET_LOCK**, and **OMP_UNSET_LOCK** regions.
- During **OMP_TEST_LOCK**, **OMP_SET_NEST_LOCK**, **OMP_UNSET_NEST_LOCK** and **OMP_TEST_NEST_LOCK** regions, if the region causes the lock to be set or unset.

Examples

In the following example, two threads perform calculations in parallel and are synchronized when the calculations are complete:

```

PROGRAM P
USE OMP_LIB
INTEGER INSYNC(0:1), IAM

!$OMP PARALLEL DEFAULT(PRIVATE) SHARED(INSYNC) NUM_THREADS(2)"
  IAM = OMP_GET_THREAD_NUM()
  INSYNC(IAM) = 0
!$OMP BARRIER
  CALL WORK
!$OMP FLUSH(INSYNC)
  INSYNC(IAM) = 1
!$OMP FLUSH(INSYNC)
  DO WHILE (INSYNC(1-IAM) .eq. 0)
!$OMP FLUSH(INSYNC)
  END DO

!$OMP END PARALLEL

END PROGRAM P

SUBROUTINE WORK
!
  ...
!$OMP FLUSH
END SUBROUTINE WORK

```

! Each thread sets a flag
! once it has
! completed its work.
! One thread waits for
! another to complete
! its work.

! Each thread does indep-
! endent calculations.

! flush work variables
! before INSYNC
! is flushed.

MASTER / END MASTER

Purpose

The **MASTER** construct enables you to define a block of code that will be run by only the master thread of the team. It includes a **MASTER** directive that precedes a block of code and ends with an **END MASTER** directive.

The **MASTER** and **END MASTER** directives only take effect if you specify the **-qsmp** compiler option.

Syntax



block represents the block of code that will be run by the master thread of the team.

Rules

It is illegal to branch into or out of a **MASTER** construct.

A **MASTER** directive binds to the closest enclosing **PARALLEL** region, if one exists.

A **MASTER** directive cannot appear within a work-sharing region or a **TASK** region.

No implied barrier exists on entry to, or exit from, the **MASTER** construct.

Examples

Example 1: An example of the **MASTER** directive binding to the **PARALLEL** directive.

```
!$OMP PARALLEL DEFAULT(SHARED)
!$OMP MASTER
    Y = 10.0
    X = 0.0
    DO I = 1, 4
        X = X + COS(Y) + I
    END DO
!$OMP END MASTER
!$OMP BARRIER
!$OMP DO PRIVATE(J)
    DO J = 1, 10000
        A(J) = X + SIN(J*2.5)
    END DO
!$OMP END DO
!$OMP END PARALLEL
END
```

Related reference:

 See `-qsmp` in the Compiler Reference
“**PARALLEL / END PARALLEL**” on page 121
“**DO / END DO**” on page 111

ORDERED / END ORDERED

Purpose

The **ORDERED / END ORDERED** directives cause the iterations of a block of code within a parallel loop to be executed in the order that the loop would execute in if it was run sequentially. You can force the code inside the **ORDERED** construct to run in a predictable order while code outside of the construct runs in parallel.

The **ORDERED** and **END ORDERED** directives only take effect if you specify the **-qsmp** compiler option.

Syntax

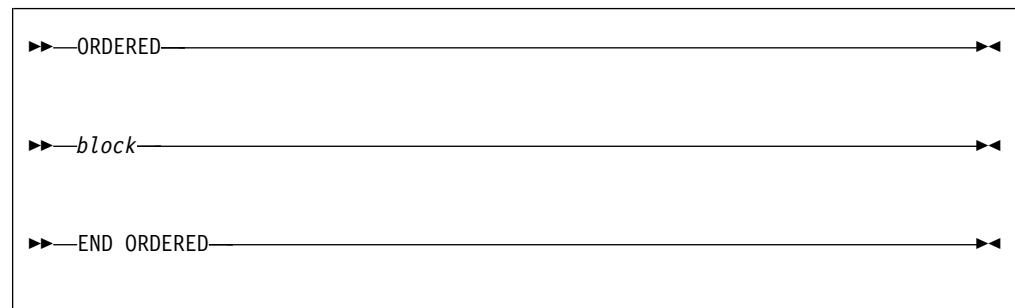

block represents the block of code that will be executed in sequence.

Rules

The **ORDERED** directive can only appear in the dynamic extent of a **DO** or **PARALLEL DO** directive. It is illegal to branch into or out of an **ORDERED** construct.

The **ORDERED** directive binds to the nearest dynamically enclosing **DO** or **PARALLEL DO** directive. You must specify the **ORDERED** clause on the **DO** or **PARALLEL DO** directive to which the **ORDERED** construct binds.

ORDERED constructs that bind to different **DO** directives are independent of each other.

Only one thread can execute an **ORDERED** construct at a time. Threads enter the **ORDERED** construct in the order of the loop iterations. A thread will enter the **ORDERED** construct if all of the previous iterations have either executed the construct or will never execute the construct.

Each iteration of a parallel loop with an **ORDERED** construct can only execute that **ORDERED** construct once. Each iteration of a parallel loop can execute at most one **ORDERED** directive. An **ORDERED** construct cannot appear within the dynamic extent of a **CRITICAL** construct.

The **END ORDERED** directive implies the **FLUSH** directive without the *variable_name_list*

Examples

Example 1: In this example, an **ORDERED** parallel loop counts down.

```
PROGRAM P
!$OMP PARALLEL DO ORDERED
DO I = 3, 1, -1
!$OMP ORDERED
CALL C_PRINT(I) ! print I using routine written in C
!$OMP END ORDERED
END DO
END PROGRAM P
```

The expected output of this program is:

```
3
2
1
```

Example 2: This example shows a program with two **ORDERED** constructs in a parallel loop. Each iteration can only execute a single section.

```
PROGRAM P
!$OMP PARALLEL DO ORDERED
DO I = 1, 3
IF (MOD(I,2) == 0) THEN
!$OMP ORDERED
CALL C_PRINT(I*10) ! print I*10 using routine written in C
!$OMP END ORDERED
ELSE
!$OMP ORDERED
CALL C_PRINT(I) ! print I using routine written in C
!$OMP END ORDERED
END IF
END DO
END PROGRAM P
```

The expected output of this program is:

```
1
20
3
```

Example 3: In this example, the program computes the sum of all elements of an array that are greater than a threshold. **ORDERED** is used to ensure that the results are always reproducible: roundoff will take place in the same order every time the program is executed, so the program will always produce the same results.

```
PROGRAM P
REAL :: A(1000)
REAL :: THRESHOLD = 999.9
REAL :: SUM = 0.0

!$OMP PARALLEL DO ORDERED
DO I = 1, 1000
IF (A(I) > THRESHOLD) THEN
!$OMP ORDERED
SUM = SUM + A(I)
!$OMP END ORDERED
END IF
END DO
END PROGRAM P
```

Note: To avoid bottleneck situations when using the **ORDERED** clause, you can try using **DYNAMIC** scheduling or **STATIC** scheduling with a small chunk size. For more information on scheduling parameters, see the “**SCHEDULE**” on page 175 clause.

Related reference:



- See `-qsmp` in the Compiler Reference
- “**PARALLEL DO / END PARALLEL DO**” on page 123
- “**DO / END DO**” on page 111
- “**CRITICAL / END CRITICAL**” on page 109

PARALLEL / END PARALLEL

Purpose

The **PARALLEL** construct enables you to define a block of code that can be executed by a team of threads concurrently. The **PARALLEL** construct includes a **PARALLEL** directive that is followed by one or more blocks of code, and ends with an **END PARALLEL** directive.

The **PARALLEL** and **END PARALLEL** directives only take effect if you specify the `-qsmp` compiler option.

Syntax

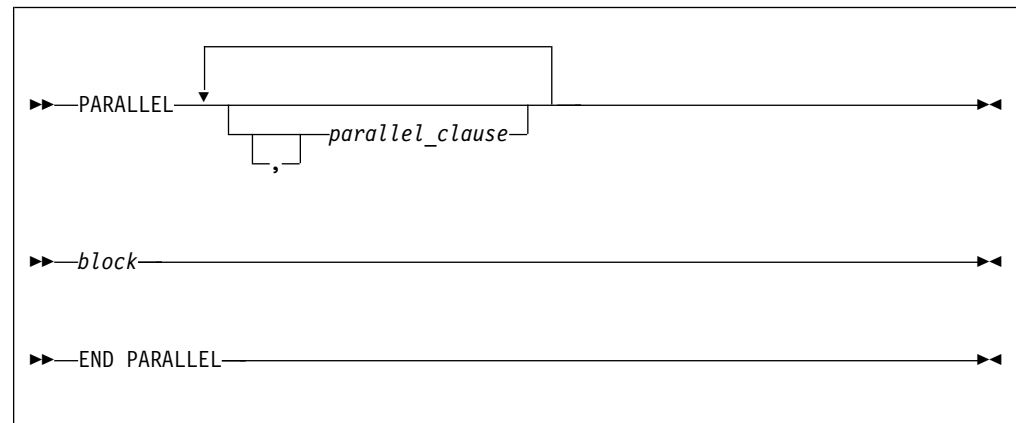

where *parallel_clause* is:



copyin clause

See — “**COPYIN**” on page 159

default **clause**

See — “DEFAULT” on page 161

if **clause**

See — “IF” on page 165

firstprivate **clause**

See — “FIRSTPRIVATE” on page 163.

num_threads **clause**

See — “NUM_THREADS” on page 168.

private **clause**

See — “PRIVATE” on page 169.

proc_bind **clause**

See — “PROC_BIND” on page 171.

reduction **clause**

See — “REDUCTION” on page 172

shared **clause**

See — “SHARED” on page 178

Rules

It is illegal to branch into or out of a **PARALLEL** construct.

The **IF** and **DEFAULT** clauses can appear at most once in a **PARALLEL** directive.

You should be careful when you perform input/output operations in a parallel region. If multiple threads execute a Fortran I/O statement on the same unit, you should make sure that the threads are synchronized. If you do not, the behavior is undefined. See “Parallel I/O issues” on page 293 for more information. Also note that although in the XL Fortran implementation each thread has exclusive access to the I/O unit, the OpenMP specification does not require exclusive access.

Directives that bind to a parallel region will bind to that parallel region even if it is serialized.

The **END PARALLEL** directive implies the **FLUSH** directive without the *variable_name_list* and a **BARRIER** directive.

Examples

Example 1: An example of an outer **PARALLEL** directive with the **PRIVATE** clause enclosing the **PARALLEL** construct. Note: The **SHARED** clause is present on the inner **PARALLEL** construct.

```
!$OMP PARALLEL PRIVATE(X)
!$OMP DO
    DO I = 1, 10
        X(I) = I
!$OMP PARALLEL SHARED (X,Y)
!$OMP DO
    DO K = 1, 10
        Y(K,I) = K * X(I)
    END DO
!$OMP END DO
```

```
!$OMP END PARALLEL
  END DO
!$OMP END DO
!$OMP END PARALLEL
```

Example 2: This example demonstrates the use of the **COPYIN** clause. Each thread created by the **PARALLEL** directive has its own copy of the common block **BLOCK**. The **COPYIN** clause causes the initial value of *FCTR* to be copied into the threads that execute iterations of the **DO** loop.

```
PROGRAM TT
COMMON /BLOCK/ FCTR
INTEGER :: I, FCTR
!$OMP THREADPRIVATE(/BLOCK/)
INTEGER :: A(100)

FCTR = -1
A = 0

!$OMP PARALLEL COPYIN(FCTR)
!$OMP DO
DO I=1, 100
  FCTR = FCTR + I
  CALL SUB(A(I), I)
ENDDO
!$OMP END PARALLEL

PRINT *, A
END PROGRAM

SUBROUTINE SUB(AA, J)
INTEGER :: FCTR, AA, J
COMMON /BLOCK/ FCTR
!$OMP THREADPRIVATE(/BLOCK/) ! EACH THREAD GETS ITS OWN COPY
                              ! OF BLOCK.
AA = FCTR
FCTR = FCTR - J
END SUBROUTINE SUB
```

The expected output is:

```
0 1 2 3 ... 96 97 98 99
```

Related reference:

“FLUSH” on page 115

“PARALLEL DO / END PARALLEL DO”

 See INDEPENDENT in the Language Reference

“THREADPRIVATE” on page 146

“DO / END DO” on page 111

 See -qdirective in the Compiler Reference

 See -qsmp in the Compiler Reference

PARALLEL DO / END PARALLEL DO

Purpose

The **PARALLEL DO** directive enables you to specify which loops the compiler should parallelize. This is semantically equivalent to:

```

!$OMP PARALLEL
!$OMP DO
...
!$OMP ENDDO
!$OMP END PARALLEL

```

and is a convenient way of parallelizing loops. The **END PARALLEL DO** directive allows you to indicate the end of a **DO** loop that is specified by the **PARALLEL DO** directive.

The **PARALLEL DO** and **END PARALLEL DO** directives only take effect if you specify the **-qsmp** compiler option.

Syntax

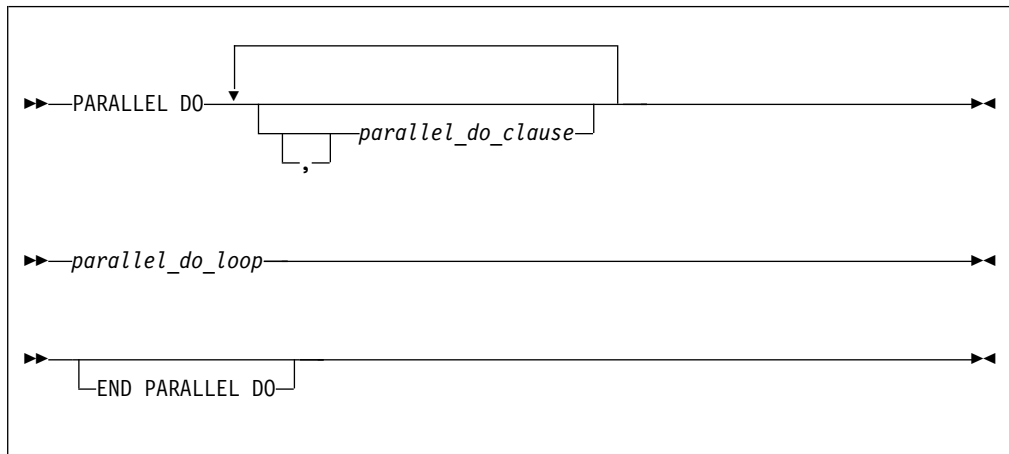

where *parallel_do_clause* is:

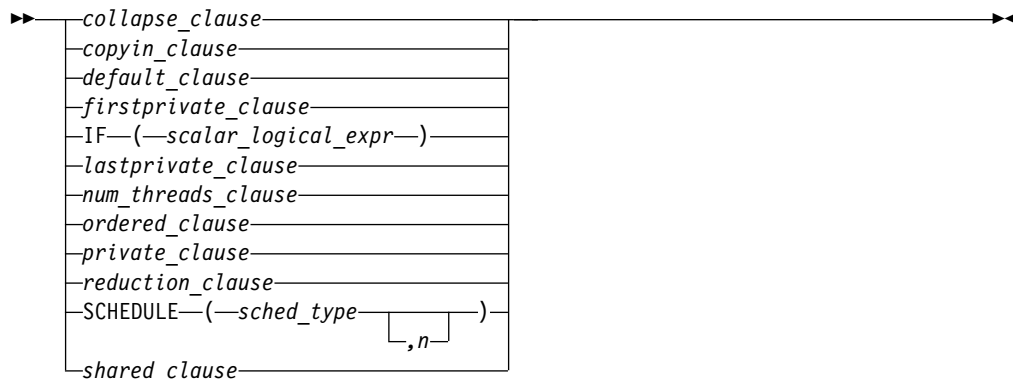

collapse_clause
See — “COLLAPSE” on page 156

copyin_clause
See — “COPYIN” on page 159

default_clause
See — “DEFAULT” on page 161

if_clause
See — “IF” on page 165.

firstprivate_clause
See — “FIRSTPRIVATE” on page 163.

lastprivate_clause
See — “LASTPRIVATE” on page 165.

num_threads_clause
See — “NUM_THREADS” on page 168.

ordered_clause
See — “ORDERED” on page 168

private_clause
See — “PRIVATE” on page 169

reduction_clause
See — “REDUCTION” on page 172

schedule_clause
See — “SCHEDULE” on page 175

shared_clause
See — “SHARED” on page 178

Rules

The first noncomment line (not including other directives) that is following the **PARALLEL DO** directive must be a **DO** loop. This line cannot be an infinite **DO** or **DO WHILE** loop. The **PARALLEL DO** directive applies only to the **DO** loop that is immediately following the directive, and not to any nested **DO** loops, unless the **COLLAPSE** clause is specified.

If you specify a **DO** loop by a **PARALLEL DO** directive, the **END PARALLEL DO** directive is optional. If you use the **END PARALLEL DO** directive, it must immediately follow the end of the **DO** loop.

You may have a **DO** construct that contains several **DO** statements. If the **DO** statements share the same **DO** termination statement, and an **END PARALLEL DO** directive follows the construct, you can only specify a **PARALLEL DO** directive for the outermost **DO** statement of the construct.

You must not follow the **PARALLEL DO** directive by a **DO** (work-sharing) or **DO SERIAL** directive. You can specify only one **PARALLEL DO** directive for a given **DO** loop.

All work-sharing constructs and **BARRIER** directives that are encountered must be encountered in the same order by all threads in the team.

The **PARALLEL DO** directive must not appear with the **INDEPENDENT** directive for a given **DO** loop.

Note: You should use the **PARALLEL DO** directive for maximum portability across multiple vendors. The **PARALLEL DO** directive is a prescriptive directive, while the **INDEPENDENT** directive is an assertion about the characteristics of the loop. (See the **INDEPENDENT** directive in the *XL Fortran Language Reference* for more information.)

The **IF** clause may appear at most once in a **PARALLEL DO** directive.

An **IF** expression is evaluated outside of the context of the parallel construct. Any function reference in the **IF** expression must not have side effects.

By default, a nested parallel loop is serialized, regardless of the setting of the **IF** clause. You can change this default by using the **-qsmp=nested_par** compiler option.

If the **REDUCTION** variable of an inner **DO** loop appears in the **PRIVATE** or **LASTPRIVATE** clause of an enclosing **DO** loop or **PARALLEL SECTIONS** construct, the variable must be initialized before the inner **DO** loop.

A variable that appears in the **REDUCTION** clause of an **INDEPENDENT** directive of an enclosing **DO** loop must not also appear in the *data_scope_entity_list* of the **PRIVATE** or **LASTPRIVATE** clause.

Within a **PARALLEL DO** construct, variables that do not appear in the **PRIVATE** clause are assumed to be shared by default.

You should be careful when you perform input/output operations in a parallel region. If multiple threads execute a Fortran I/O statement on the same unit, you should make sure that the threads are synchronized. If you do not, the behavior is undefined. Also note that although in the XL Fortran implementation each thread has exclusive access to the I/O unit, the OpenMP specification does not require exclusive access.

Directives that bind to a parallel region will bind to that parallel region even if it is serialized.

The **END PARALLEL DO** directive implies the **FLUSH** directive without the *variable_name_list* and a **BARRIER** directive.

Examples

Example 1: A valid example with the **LASTPRIVATE** clause.

```
!$OMP PARALLEL DO PRIVATE(I), LASTPRIVATE (X)
  DO I = 1,10
    X = I * I
    A(I) = X * B(I)
  END DO
PRINT *, X                                ! X has the value 100
```

Example 2: A valid example with the **REDUCTION** clause.

```
!$OMP PARALLEL DO PRIVATE(I), REDUCTION(+:MYSUM)
  DO I = 1, 10
    MYSUM = MYSUM + IARR(I)
  END DO
```

Example 3: A valid example where more than one thread accesses a variable that is marked as **SHARED**, but the variable is used only in a **CRITICAL** construct.

```
!$OMP PARALLEL DO SHARED (X)
  DO I = 1, 10
    A(I) = A(I) * I
  !$OMP CRITICAL
    X = X + A(I)
  !$OMP END CRITICAL
  END DO
```

Example 4: A valid example of the **END PARALLEL DO** directive.

```

      REAL A(100), B(2:100), C(100)
!$OMP PARALLEL DO
      DO I = 2, 100
        B(I) = (A(I) + A(I-1))/2.0
      END DO
!$OMP END PARALLEL DO
!$OMP PARALLEL DO
      DO J = 1, 100
        C(J) = X + COS(J*5.5)
      END DO
!$OMP END PARALLEL DO
      END

```

Related reference:

“COLLAPSE” on page 156



See `-qdirective` in the Compiler Reference



See `-qsmp` in the Compiler Reference



See `DO` in the Language Reference

“`DO / END DO`” on page 111



See `INDEPENDENT` in the Language Reference

“`ORDERED / END ORDERED`” on page 119

“`PARALLEL / END PARALLEL`” on page 121

“`PARALLEL SECTIONS / END PARALLEL SECTIONS`”

“`SCHEDULE`” on page 130

“`THREADPRIVATE`” on page 146

PARALLEL SECTIONS / END PARALLEL SECTIONS

Purpose

The **PARALLEL SECTIONS** construct provides a short form method for including **SECTIONS** directive inside a **PARALLEL** construct.

The **PARALLEL SECTIONS**, **SECTION** and **END PARALLEL SECTIONS** directives only take effect if you specify the **-qsmp** compiler option.

Syntax

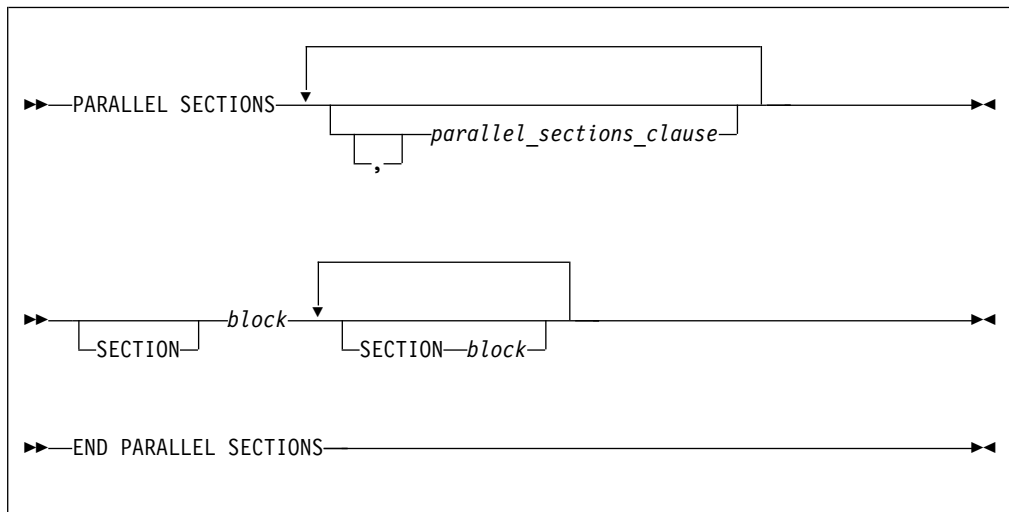

where *parallel_sections_clause* is:



copyin clause

See — “COPYIN” on page 159

default clause

See — “DEFAULT” on page 161

firstprivate clause

See — “FIRSTPRIVATE” on page 163.

if clause

See — “IF” on page 165

lastprivate clause

See — “LASTPRIVATE” on page 165.

num_threads clause

See — “NUM_THREADS” on page 168.

private clause

See — “PRIVATE” on page 169.

proc_bind clause

See — “PROC_BIND” on page 171.

reduction clause

See — “REDUCTION” on page 172

shared clause

See — “SHARED” on page 178

Rules

See the Rules section in “SECTIONS / END SECTIONS” on page 133.

In a **PARALLEL SECTIONS** construct, a variable that appears in the **REDUCTION** clause of an **INDEPENDENT** directive or the **PARALLEL DO** directive of an enclosing **DO** loop must not also appear in the *data_scope_entity_list* of the **PRIVATE** clause.

If the **REDUCTION** variable of the inner **PARALLEL SECTIONS** construct appears in the **PRIVATE** clause of an enclosing **DO** loop or **PARALLEL SECTIONS** construct, the variable must be initialized before the inner **PARALLEL SECTIONS** construct.

Examples

Example 1:

```
!$OMP PARALLEL SECTIONS
!$OMP SECTION
    DO I = 1, 10
        C(I) = MAX(A(I),A(I+1))
    END DO
!$OMP SECTION
    W = U + V
    Z = X + Y
!$OMP END PARALLEL SECTIONS
```

Example 2: In this example, the index variable I is declared as **PRIVATE**. Note also that the first optional **SECTION** directive has been omitted.

```
!$OMP PARALLEL SECTIONS PRIVATE(I)
    DO I = 1, 100
        A(I) = A(I) * I
    END DO
!$OMP SECTION
    CALL NORMALIZE (B)
    DO I = 1, 100
        B(I) = B(I) + 1.0
    END DO
!$OMP SECTION
    DO I = 1, 100
        C(I) = C(I) * C(I)
    END DO
!$OMP END PARALLEL SECTIONS
```

Related reference:

“PARALLEL / END PARALLEL” on page 121

“SECTIONS / END SECTIONS” on page 133



See **INDEPENDENT** in the Language Reference



See **-qdirective** in the Compiler Reference



See **-qsmp** in the Compiler Reference

PARALLEL WORKSHARE / END PARALLEL WORKSHARE

Purpose

The **PARALLEL WORKSHARE** construct provides a short form method for including a **WORKSHARE** directive inside a **PARALLEL** construct.

The **PARALLEL WORKSHARE / END PARALLEL WORKSHARE** directives only take effect if you specify the **-qsmp** compiler option

Syntax

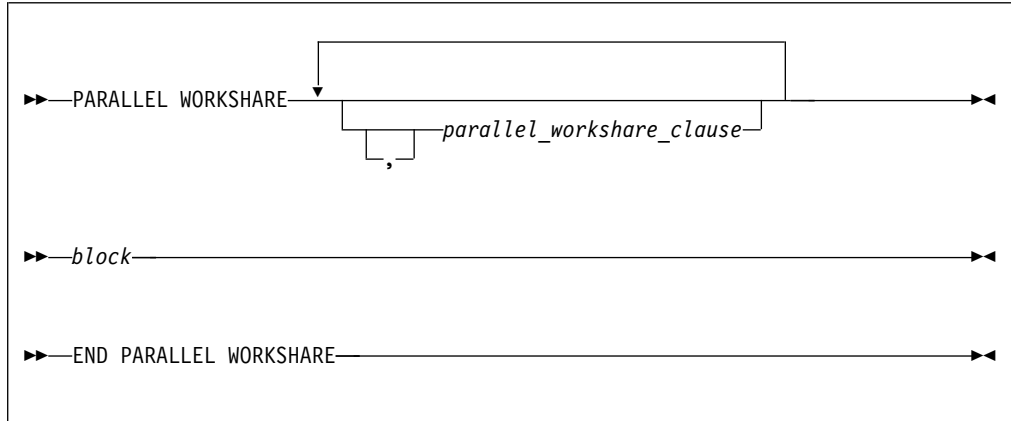

where *parallel_workshare_clause* is any of the directives accepted by either the **PARALLEL** or **WORKSHARE** directives.

Related reference:

“**PARALLEL / END PARALLEL**” on page 121

“**WORKSHARE / END WORKSHARE**” on page 151

SCHEDULE

Purpose

Note: The **SCHEDULE** directive has been deprecated and might be removed in a future release. Use the corresponding OpenMP **SCHEDULE** clause. For more information about the deprecated SMP directives and deprecation examples, see “Deprecated directive” on page 102.

The **SCHEDULE** directive allows the user to specify the chunking method for parallelization. Work is assigned to threads in different manners depending on the scheduling type or chunk size used.

The **SCHEDULE** directive only takes effect if you specify the **-qsmp** compiler option.

Syntax

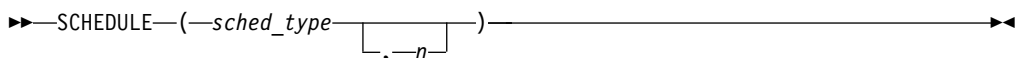

n *n* must be a positive, specification expression. You must not specify *n* for the *sched_type* **RUNTIME**.

sched_type

is **AFFINITY**, **DYNAMIC**, **GUIDED**, **RUNTIME**, or **STATIC**

For more information on *sched_type* parameters, see the **SCHEDULE** clause.

number_of_iterations

is the number of iterations in the loop to be parallelized.

number_of_threads

is the number of threads used by the program.

Rules

The **SCHEDULE** directive must appear in the specification part of a scoping unit.

Only one **SCHEDULE** directive may appear in the specification part of a scoping unit.

The **SCHEDULE** directive applies to the situation when all loops in the scoping unit do not already have explicit scheduling types specified. Individual loops can have scheduling types specified using the **SCHEDULE** clause of the **PARALLEL DO** directive.

Any dummy arguments appearing or referenced in the specification expression for the chunk size *n* must also appear in the **SUBROUTINE** or **FUNCTION** statement and in all **ENTRY** statements appearing in the given subprogram.

If the specified chunk size *n* is greater than the number of iterations, the loop will not be parallelized and will execute on a single thread.

If you specify more than one method of determining the chunking algorithm, the compiler will follow, in order of precedence:

1. **SCHEDULE** clause to the **PARALLEL DO** directive.
2. **SCHEDULE** directive.
3. **schedule** suboption to the **-qsmp** compiler option. See the **-qsmp** option in the *XL Fortran Compiler Reference*.
4. **XLSMPOPTS** runtime option. See “**XLSMPOPTS**” on page 80.
5. runtime default (that is, **STATIC**).

Examples

Example 1. Given the following information:

```
number of iterations = 1000  
number of threads = 4
```

and using the **GUIDED** scheduling type, the chunk sizes would be as follows:

```
250 188 141 106 79 59 45 33 25 19 14 11 8 6 4 3 3 2 1 1 1 1
```

The iterations would then be divided into the following chunks:

```
chunk 1 = iterations 1 to 250  
chunk 2 = iterations 251 to 438  
chunk 3 = iterations 439 to 579  
chunk 4 = iterations 580 to 685  
chunk 5 = iterations 686 to 764  
chunk 6 = iterations 765 to 823  
chunk 7 = iterations 824 to 868  
chunk 8 = iterations 869 to 901
```

```
chunk 9 = iterations 902 to 926
chunk 10 = iterations 927 to 945
chunk 11 = iterations 946 to 959
chunk 12 = iterations 960 to 970
chunk 13 = iterations 971 to 978
chunk 14 = iterations 979 to 984
chunk 15 = iterations 985 to 988
chunk 16 = iterations 989 to 991
chunk 17 = iterations 992 to 994
chunk 18 = iterations 995 to 996
chunk 19 = iterations 997 to 997
chunk 20 = iterations 998 to 998
chunk 21 = iterations 999 to 999
chunk 22 = iterations 1000 to 1000
```

A possible scenario for the division of work could be:

```
thread 1 executes chunks 1 5 10 13 18 20
thread 2 executes chunks 2 7 9 14 16 22
thread 3 executes chunks 3 6 12 15 19
thread 4 executes chunks 4 8 11 17 21
```

Example 2. Given the following information:

```
number of iterations = 100
number of threads = 4
```

and using the **AFFINITY** scheduling type, the iterations would be divided into the following partitions:

```
partition 1 = iterations 1 to 25
partition 2 = iterations 26 to 50
partition 3 = iterations 51 to 75
partition 4 = iterations 76 to 100
```

The partitions would be divided into the following chunks:

```
chunk 1a = iterations 1 to 13
chunk 1b = iterations 14 to 19
chunk 1c = iterations 20 to 22
chunk 1d = iterations 23 to 24
chunk 1e = iterations 25 to 25

chunk 2a = iterations 26 to 38
chunk 2b = iterations 39 to 44
chunk 2c = iterations 45 to 47
chunk 2d = iterations 48 to 49
chunk 2e = iterations 50 to 50

chunk 3a = iterations 51 to 63
chunk 3b = iterations 64 to 69
chunk 3c = iterations 70 to 72
chunk 3d = iterations 73 to 74
chunk 3e = iterations 75 to 75

chunk 4a = iterations 76 to 88
chunk 4b = iterations 89 to 94
chunk 4c = iterations 95 to 97
chunk 4d = iterations 98 to 99
chunk 4e = iterations 100 to 100
```

A possible scenario for the division of work could be:

```
thread 1 executes chunks 1a 1b 1c 1d 1e 4d
thread 2 executes chunks 2a 2b 2c 2d
thread 3 executes chunks 3a 3b 3c 3d 3e 2e
thread 4 executes chunks 4a 4b 4c 4e
```

In this scenario, thread 1 finished executing all the chunks in its partition and then grabbed an available chunk from the partition of thread 4. Similarly, thread 3 finished executing all the chunks in its partition and then grabbed an available chunk from the partition of thread 2.

Example 3. Given the following information:

```
number of iterations = 1000  
number of threads = 4
```

and using the **DYNAMIC** scheduling type and chunk size of 100, the chunk sizes would be as follows:

```
100 100 100 100 100 100 100 100 100 100
```

The iterations would be divided into the following chunks:

```
chunk 1 = iterations 1 to 100  
chunk 2 = iterations 101 to 200  
chunk 3 = iterations 201 to 300  
chunk 4 = iterations 301 to 400  
chunk 5 = iterations 401 to 500  
chunk 6 = iterations 501 to 600  
chunk 7 = iterations 601 to 700  
chunk 8 = iterations 701 to 800  
chunk 9 = iterations 801 to 900  
chunk 10 = iterations 901 to 1000
```

A possible scenario for the division of work could be:

```
thread 1 executes chunks 1 5 9  
thread 2 executes chunks 2 8  
thread 3 executes chunks 3 6 10  
thread 4 executes chunks 4 7
```

Example 4. Given the following information:

```
number of iterations = 100  
number of threads = 4
```

and using the **STATIC** scheduling type, the iterations would be divided into the following chunks:

```
chunk 1 = iterations 1 to 25  
chunk 2 = iterations 26 to 50  
chunk 3 = iterations 51 to 75  
chunk 4 = iterations 76 to 100
```

A possible scenario for the division of work could be:

```
thread 1 executes chunks 1  
thread 2 executes chunks 2  
thread 3 executes chunks 3  
thread 4 executes chunks 4
```

Related reference:

 See DO in the Language Reference

SECTIONS / END SECTIONS

Purpose

The **SECTIONS** construct defines distinct blocks of code to be executed in parallel by threads in the team.

The **SECTIONS** and **END SECTIONS** directives only take effect if you specify the **-qsmp** compiler option.

Syntax

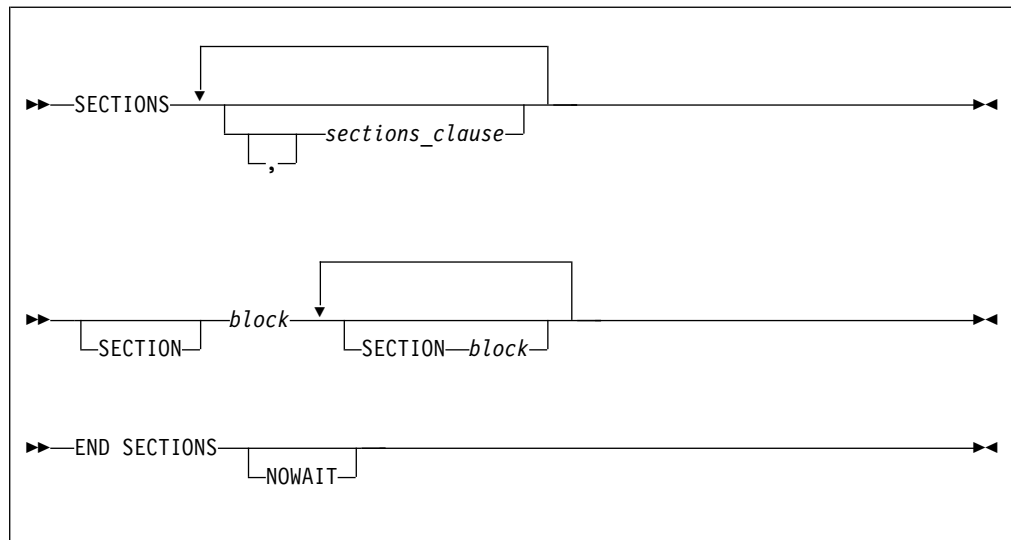

where *sections_clause* is:



firstprivate_clause

See — “FIRSTPRIVATE” on page 163.

lastprivate_clause

See — “LASTPRIVATE” on page 165.

private_clause

See — “PRIVATE” on page 169.

reduction_clause

See — “REDUCTION” on page 172

Rules

The **SECTIONS** construct must be encountered by all threads in a team or by none of the threads in a team. All work-sharing constructs and **BARRIER** directives that are encountered must be encountered in the same order by all threads in the team.

The **SECTIONS** construct includes the delimiting directives, and the blocks of code they enclose. At least one block of code must appear in the construct.

You must specify the **SECTION** directive at the beginning of each block of code except for the first. The end of a block is delimited by either another **SECTION** directive or by the **END SECTIONS** directive.

It is illegal to branch into or out of any block of code that is enclosed in the **SECTIONS** construct. All **SECTION** directives must appear within the lexical extent of the **SECTIONS/END SECTIONS** directive pair.

The scheduling of structured blocks among threads in the team is set so that the first thread arriving is the first thread to execute the block. The compiler determines how to divide the work among the threads based on a number of factors, such as the number of threads in the team and the number of sections to be executed in parallel. In a **SECTIONS** construct, a single thread might execute more than one **SECTION**. It is also possible that a thread in the team might not execute any **SECTION**.

In order for the directive to execute in parallel, you must place the **SECTIONS/END SECTIONS** pair within a parallel region. Otherwise, the blocks will be executed serially.

If you specify **NOWAIT** on the **SECTIONS** directive, a thread that completes its sections early will proceed to the instructions following the **SECTIONS** construct. If you do not specify the **NOWAIT** clause, each thread will wait for all of the other threads in the same team to reach the **END SECTIONS** directive. However, there is no implied **BARRIER** at the start of the **SECTIONS** construct.

You cannot specify a **SECTIONS** directive within the dynamic extent of a **CRITICAL**, **MASTER**, **ORDERED**, or **TASK** directive.

You cannot nest **SECTIONS**, **DO** or **SINGLE** directives that bind to the same **PARALLEL** directive.

BARRIER and **MASTER** directives are not permitted in the dynamic extent of a **SECTIONS** directive.

The **END SECTIONS** directive implies the **FLUSH** directive.

Examples

Example 1: This example shows a valid use of the **SECTIONS** construct within a **PARALLEL** region.

```

      INTEGER :: I, B(500), S, SUM
! ...
      S = 0
      SUM = 0
!$OMP PARALLEL SHARED(SUM), FIRSTPRIVATE(S)
!$OMP SECTIONS REDUCTION(+: SUM), LASTPRIVATE(I)
!$OMP SECTION
      S = FCT1(B(1::2)) ! Array B is not altered in FCT1.
      SUM = SUM + S
! ...
!$OMP SECTION
      S = FCT2(B(2::2)) ! Array B is not altered in FCT2.
      SUM = SUM + S
! ...
!$OMP SECTION
      DO I = 1, 500      ! The local copy of S is initialized
        S = S + B(I)    ! to zero.
      END DO
      SUM = SUM + S
! ...
!$OMP END SECTIONS
! ...

```

```

!$OMP DO REDUCTION(-: SUM)
  DO J=I-1, 1, -1    ! The loop starts at 500 -- the last
                    ! value from the previous loop.
    SUM = SUM - B(J)
  END DO

!$OMP MASTER
  SUM = SUM - FCT1(B(1::2)) - FCT2(B(2::2))
!$OMP END MASTER
!$OMP END PARALLEL
! ...
                                ! Upon termination of the PARALLEL
                                ! region, the value of SUM remains zero.

```

Example 2: This example shows a valid use of nested **SECTIONS**.

```

!$OMP PARALLEL
!$OMP MASTER
  CALL RANDOM_NUMBER(CX)
  CALL RANDOM_NUMBER(CY)
  CALL RANDOM_NUMBER(CZ)
!$OMP END MASTER

!$OMP SECTIONS
!$OMP SECTION
!$OMP PARALLEL
!$OMP SECTIONS PRIVATE(I)
!$OMP SECTION
  DO I=1, 5000
    X(I) = X(I) + CX
  END DO
!$OMP SECTION
  DO I=1, 5000
    Y(I) = Y(I) + CY
  END DO
!$OMP END SECTIONS
!$OMP END PARALLEL

!$OMP SECTION
!$OMP PARALLEL SHARED(CZ,Z)
!$OMP DO
  DO I=1, 5000
    Z(I) = Z(I) + CZ
  END DO
!$OMP END DO
!$OMP END PARALLEL
!$OMP END SECTIONS NOWAIT

! The following computations do not
! depend on the results from the
! previous section.

!$OMP DO
  DO I=1, 5000
    T(I) = T(I) * CT
  END DO
!$OMP END DO
!$OMP END PARALLEL

```

Related reference:

“PARALLEL / END PARALLEL” on page 121

“BARRIER” on page 108

“PARALLEL DO / END PARALLEL DO” on page 123

 See INDEPENDENT in the Language Reference

“THREADPRIVATE” on page 146

 See `-qdirective` in the Compiler Reference

 See `-qsmp` in the Compiler Reference

SINGLE / END SINGLE

Purpose

You can use the **SINGLE / END SINGLE** directive construct to specify that the enclosed code should only be executed by one thread in the team.

The **SINGLE** directive only takes effect if you specify the `-qsmp` compiler option.

Syntax

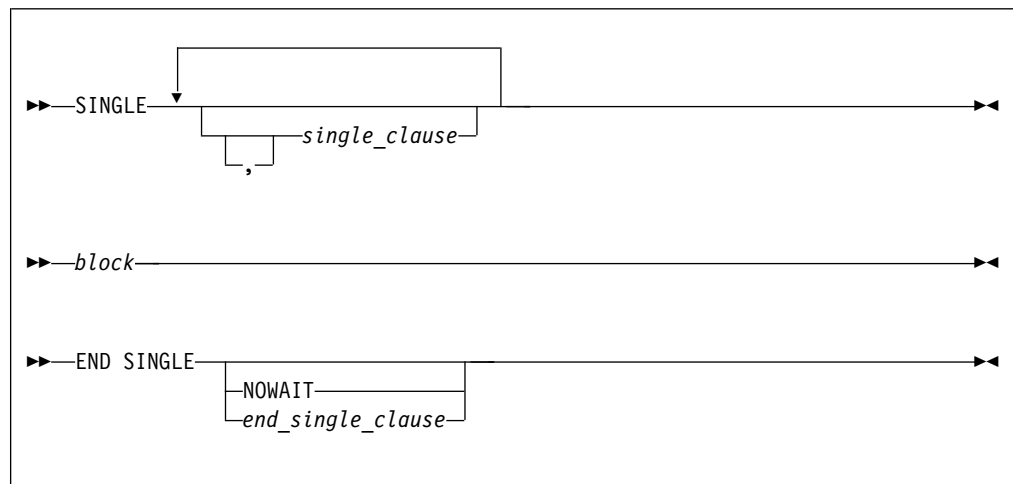

where *single_clause* is:

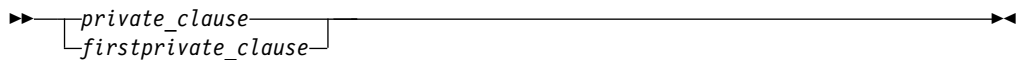

private_clause

See — “PRIVATE” on page 169.

firstprivate_clause

See — “FIRSTPRIVATE” on page 163.

where *end_single_clause* is:



NOWAIT

copyprivate_clause

See — “COPYPRIVATE” on page 160.

Rules

It is illegal to branch into or out of a block that is enclosed within the **SINGLE** construct.

The **SINGLE** construct must be encountered by all threads in a team or by none of the threads in a team. The first thread to encounter the **SINGLE** construct will execute it. All work-sharing constructs and **BARRIER** directives that are encountered must be encountered in the same order by all threads in the team.

If you specify **NOWAIT** on the **END SINGLE** directive, the threads that are not executing the **SINGLE** construct will proceed to the instructions following the **SINGLE** construct. If you do not specify the **NOWAIT** clause, each thread will wait at the **END SINGLE** directive until the thread executing the construct reaches the **END SINGLE** directive. You may not specify **NOWAIT** and **COPYPRIVATE** as part of the same **END SINGLE** directive.

There is no implied **BARRIER** at the start of the **SINGLE** construct. If you do not specify the **NOWAIT** clause, the **BARRIER** directive is implied at the **END SINGLE** directive.

You cannot nest work-sharing constructs inside one another if they bind to the same **PARALLEL** directive.

SINGLE directives are not permitted within the **CRITICAL**, **MASTER**, **ORDERED**, or **TASK** regions. **BARRIER** and **MASTER** directives are not permitted within the **SINGLE** regions.

If you have specified a variable as **PRIVATE**, **FIRSTPRIVATE**, **LASTPRIVATE**, or **REDUCTION** in the **PARALLEL** construct which encloses your **SINGLE** construct, you cannot specify the same variable in the **PRIVATE** or **FIRSTPRIVATE** clause of the **SINGLE** construct.

The **SINGLE** directive binds to the closest enclosing **PARALLEL** region, if one exists.

Examples

Example 1: In this example, the **BARRIER** directive is used to ensure that all threads finish their work before entering the **SINGLE** construct.

```
      REAL :: X(100), Y(50)
!
...
!$OMP PARALLEL DEFAULT(SHARED)
      CALL WORK(X)

!$OMP BARRIER
!$OMP SINGLE
      CALL OUTPUT(X)
      CALL INPUT(Y)
!$OMP END SINGLE

      CALL WORK(Y)
!$OMP END PARALLEL
```

Example 2: In this example, the **SINGLE** construct ensures that only one thread is executing a block of code. In this case, array *B* is initialized in the **DO** (work-sharing) construct. After the initialization, a single thread is employed to perform the summation.

```

        INTEGER :: I, J
        REAL :: B(500,500), SM
!      ...

        J = ...
        SM = 0.0
!$OMP PARALLEL
!$OMP DO PRIVATE(I)
        DO I=1, 500
            CALL INITARR(B(I,:), I)      ! initialize the array B
        ENDDO
!$OMP END DO

!$OMP SINGLE                          ! employ only one thread
        DO I=1, 500
            SM = SM + SUM(B(J:J+1,I))
        ENDDO
!$OMP END SINGLE

!$OMP DO PRIVATE(I)
        DO I=500, 1, -1
            CALL INITARR(B(I,:), 501-I)  ! re-initialize the array B
        ENDDO
!$OMP END PARALLEL

```

Example 3: This example shows a valid use of the **PRIVATE** clause. Array *X* is **PRIVATE** to the **SINGLE** construct. If you were to reference array *X* immediately following the construct, it would be undefined.

```

        REAL :: X(2000), A(1000), B(1000)

!$OMP PARALLEL
!      ...
!$OMP SINGLE PRIVATE(X)
        CALL READ_IN_DATA(X)
        A = X(1::2)
        B = X(2::2)
!$OMP END SINGLE
!      ...
!$OMP END PARALLEL

```

Example 4: In this example, the **LASTPRIVATE** variable *I* is used in allocating *TMP*, the **PRIVATE** variable in the **SINGLE** construct.

```

        SUBROUTINE ADD(A, UPPERBOUND)
            INTEGER :: A(UPPERBOUND), I, UPPERBOUND
            INTEGER, ALLOCATABLE :: TMP(:)
!      ...
!$OMP PARALLEL
!$OMP DO LASTPRIVATE(I)
        DO I=1, UPPERBOUND
            A(I) = I + 1
        ENDDO
!$OMP END DO

!$OMP SINGLE FIRSTPRIVATE(I), PRIVATE(TMP)
        ALLOCATE(TMP(0:I-1))
        TMP = (/ A(J),J=I,1,-1 /)
!      ...
        DEALLOCATE(TMP)
!$OMP END SINGLE
!$OMP END PARALLEL
!      ...
        END SUBROUTINE ADD

```

Example 5: In this example, a value for the variable *I* is entered by the user. This value is then copied into the corresponding variable *I* for all other threads in the team using a **COPYPRIVATE** clause on an **END SINGLE** directive.

```

      INTEGER I
!$OMP PARALLEL PRIVATE (I)
!
! ...
!$OMP SINGLE
      READ (*, *) I
!$OMP END SINGLE COPYPRIVATE (I) ! In all threads in the team, I
!                               ! is equal to the value
!                               ! that you entered.
!
! ...
!$OMP END PARALLEL

```

Example 6: In this example, variable *J* with a **POINTER** attribute is specified in a **COPYPRIVATE** clause on an **END SINGLE** directive. The value of *J*, not the value of the object that it points to, is copied into the corresponding variable *J* for all other threads in the team. The object itself is shared among all the threads in the team.

```

      INTEGER, POINTER :: J
!$OMP PARALLEL PRIVATE (J)
! ...
!$OMP SINGLE
      ALLOCATE (J)
      READ (*, *) J
!$OMP END SINGLE COPYPRIVATE (J)
!$OMP ATOMIC
      J = J + OMP_GET_THREAD_NUM()
!$OMP BARRIER
!$OMP SINGLE
      WRITE (*, *) 'J = ', J ! The result is the sum of all values added to
!                           ! J. This result shows that the pointer object
!                           ! is shared by all threads in the team.
!
      DEALLOCATE (J)
!$OMP END SINGLE
!$OMP END PARALLEL

```

Related reference:

- “BARRIER” on page 108
- “CRITICAL / END CRITICAL” on page 109
- “FLUSH” on page 115
- “MASTER / END MASTER” on page 117
- “PARALLEL / END PARALLEL” on page 121

TASK / END TASK

Purpose

The **TASK** directive instructs the compiler to run a block of code in parallel with the code outside the task region. The **TASK** directive can be useful for parallelizing irregular algorithms such as pointer chasing or recursive algorithms. The **TASK** directive takes effect only if you specify the **-qsmp** compiler option.

Syntax

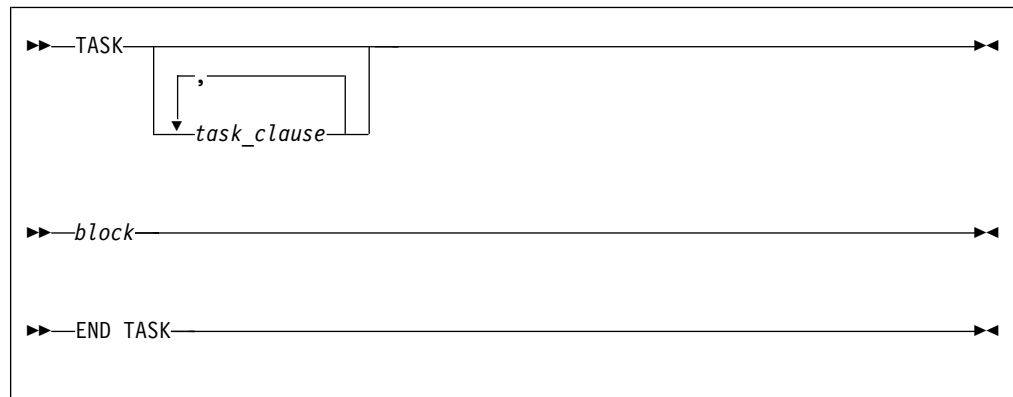

where *task_clause* is:



default_clause

See "DEFAULT" on page 161.

final_clause

See "FINAL" on page 163.

firstprivate_clause

See "FIRSTPRIVATE" on page 163.

if_clause

See "IF" on page 165.

mergeable_clause

See "MERGEABLE" on page 167.

private_clause

See "PRIVATE" on page 169.

shared_clause

See "SHARED" on page 178.

untied_clause

See "UNTIED" on page 179.

Rules

A final task is a task that makes all its child tasks become final and included tasks. A final task is generated when either of the following conditions is true:

- A **FINAL** clause is specified on a task construct and the **FINAL** clause expression evaluates to `.TRUE.`.

- The generated task is a child task of a final task.

An undeferred task is a task whose execution is not deferred with respect to its generating task region. In other words, the generating task region is suspended until the undeferred task has finished running. An undeferred task is generated when an **IF** clause is specified on a task construct and the **IF** clause expression evaluates to `.FALSE.`.

An included task is a task whose execution is sequentially included in the generating task region. In other words, an included task is undeferred and executed immediately by the encountering thread. An included task is generated when the generated task is a child task of a final task.

A merged task is a task that has the same data environment as that of its generating task region. A merged task might be generated when both the following conditions are true:

- A **MERGEABLE** clause is specified on a task construct.
- The generated task is an undeferred task or an included task.

The following rules are true if no **DEFAULT** clause is specified with the enclosing **TASK** construct:

- If the enclosing **TASK** construct is not lexically enclosed by a parallel region, dummy arguments that do not appear in any **PRIVATE**, **FIRSTPRIVATE**, **LASTPRIVATE**, or **SHARED** clause of the enclosing **TASK** construct are `firstprivate`.
- A variable that is private in the innermost enclosing parallel construct is `firstprivate` in the **TASK** construct.
- Local variables of a routine are `firstprivate` if there is no enclosing parallel construct.
- A variable that is determined to be shared in all of the enclosing constructs, up to and including the innermost enclosing parallel construct, is shared.

The **IF** clause expression and the **FINAL** clause expression are evaluated outside of the task construct, and the evaluation order is not specified.

Related reference:

“FINAL” on page 163

“FIRSTPRIVATE” on page 163

“IF” on page 165

“MERGEABLE” on page 167

“DEFAULT” on page 161

“PRIVATE” on page 169

“SHARED” on page 178

“TASKWAIT”

“UNTIED” on page 179

TASKWAIT

Purpose

The **TASKWAIT** directive specifies a *wait* for child tasks to be completed that are generated by the current task.

Syntax

```
▶▶—TASKWAIT—▶▶
```

Related reference:

“TASK / END TASK” on page 140

TASKYIELD

Purpose

The **TASKYIELD** directive instructs the compiler that it can suspend the current task in favor of running a different task. The **TASKYIELD** region includes an explicit task scheduling point in the current task region.



Syntax

```
▶▶—TASKYIELD—▶▶
```

THREADLOCAL

Purpose

You can use the **THREADLOCAL** directive to declare thread-specific common data. It is a possible method of ensuring that access to data that is contained within **COMMON** blocks is serialized.

In order to make use of this directive it is not necessary to specify the **-qsmp** compiler option, but the invocation command must be **xl_f_r**, **xl_f90_r**, **xl_f95_r**, **xl_f2003_r**, **xl_f2008_r**, or  **xl_cuf**  to link the necessary libraries.

Syntax

```
▶▶—THREADLOCAL—▶▶  
    [::]  
    ,  
    /—common_block_name—/
```

Rules

You can only declare named blocks as **THREADLOCAL**. All rules and constraints that normally apply to named common blocks apply to common blocks that are declared as **THREADLOCAL**. See the **COMMON** statement in the *XL Fortran Language Reference* for more information on the rules and constraints that apply to named common blocks.

The **THREADLOCAL** directive must appear in the *specification_part* of the scoping unit. If a common block appears in a **THREADLOCAL** directive, it must also be declared within a **COMMON** statement in the same scoping unit. The **THREADLOCAL** directive may occur before or after the **COMMON** statement. See Main program in the *XL Fortran Language Reference* for more information on the *specification_part* of the scoping unit.

A common block cannot be given the **THREADLOCAL** attribute if it is declared within a **PURE** subprogram.

Members of a **THREADLOCAL** common block must not appear in **NAMELIST** statements.

A common block that is use-associated must not be declared as **THREADLOCAL** in the scoping unit that contains the **USE** statement.

Any pointers declared in a **THREADLOCAL** common block are not affected by the **-qinit=f90ptr** compiler option.

Objects within **THREADLOCAL** common blocks may be used in parallel loops and parallel sections. However, these objects are implicitly shared across the iterations of the loop, and across code blocks within parallel sections. In other words, within a scoping unit, all accessible common blocks, whether declared as **THREADLOCAL** or not, have the **SHARED** attribute within parallel loops and sections in that scoping unit.

If a common block is declared as **THREADLOCAL** within a scoping unit, any subprogram that declares or references the common block, and that is directly or indirectly referenced by the scoping unit, must be executed by the same thread executing the scoping unit. If two procedures that declare common blocks are executed by different threads, then they would obtain different copies of the common block, provided that the common block had been declared **THREADLOCAL**. Threads can be created in one of the following ways:

- Explicitly, via *pthread*s library calls
- Implicitly by the compiler for parallel loop execution
- Implicitly by the compiler for parallel section execution.

If a common block is declared to be **THREADLOCAL** in one scoping unit, it must be declared to be **THREADLOCAL** in every scoping unit that declares the common block.

If a **THREADLOCAL** common block that does not have the **SAVE** attribute is declared within a subprogram, the members of the block become undefined at subprogram **RETURN** or **END**, unless there is at least one other scoping unit in which the common block is accessible that is making a direct or indirect reference to the subprogram.

You cannot specify the same *common_block_name* for both a **THREADLOCAL** directive and a **THREADPRIVATE** directive.

Example 1: The following procedure "FORT_SUB" is invoked by two threads:

```
SUBROUTINE FORT_SUB(IARG)
  INTEGER IARG
```



```

CALL LIBRARY_ROUTINE1()
CALL LIBRARY_ROUTINE2()
...
END SUBROUTINE FORT_SUB
SUBROUTINE LIBRARY_ROUTINE1()
COMMON /BLOCK/ R
SAVE /BLOCK/
! The SAVE attribute is required for the
! common block because the program requires
! that the block remain defined after
! library_routine1 is invoked.
!IBM* THREADLOCAL /BLOCK/
R = 1.0
...
END SUBROUTINE LIBRARY_ROUTINE1
SUBROUTINE LIBRARY_ROUTINE2()
COMMON /BLOCK/ R
SAVE /BLOCK/
!IBM* THREADLOCAL /BLOCK/

... = R
...
END SUBROUTINE LIBRARY_ROUTINE2

```

Example 2: "FORT_SUB" is invoked by multiple threads. This is an invalid example because "FORT_SUB" and "ANOTHER_SUB" both declare /BLOCK/ to be THREADLOCAL. They intend to share the common block, but they are executed by different threads.

```

SUBROUTINE FORT_SUB()
COMMON /BLOCK/ J
INTEGER :: J
!IBM* THREADLOCAL /BLOCK/
! Each thread executing FORT_SUB
! obtains its own copy of /BLOCK/

INTEGER A(10)

...
!IBM* INDEPENDENT
DO INDEX = 1,10
CALL ANOTHER_SUB(A(I))
END DO
...

END SUBROUTINE FORT_SUB
SUBROUTINE ANOTHER_SUB(AA)
INTEGER AA
COMMON /BLOCK/ J
INTEGER :: J
!IBM* THREADLOCAL /BLOCK/
...
AA = J
! The value of 'J' is undefined.
END SUBROUTINE ANOTHER_SUB

```

! Multiple threads are used to execute ANOTHER_SUB
! Each thread obtains a new copy of the
! common block /BLOCK/

Related reference:



See -qdirective in the Compiler Reference



See -qinit in the Compiler Reference



See COMMON in the Language Reference



See Main program in the Language Reference

THREADPRIVATE

Purpose

The **THREADPRIVATE** directive allows you to specify named common blocks and named variables as private to a thread but global within that thread. Once you declare a common block or variable **THREADPRIVATE**, each thread in the team maintains a separate copy of that common block or variable. Data written to a **THREADPRIVATE** common block or variable remains private to that thread and is not visible to other threads in the team.

In the serial and **MASTER** sections of a program, only the master thread's copy of the named common block and variable is accessible.

Use the **COPYIN** clause on the **PARALLEL**, **PARALLEL DO**, **PARALLEL SECTIONS** or **PARALLEL WORKSHARE** directives to specify that upon entry into a parallel region, data in the master thread's copy of a named common block or named variable is copied to each thread's private copy of that common block or variable.

The **THREADPRIVATE** directive only takes effect if you specify the **-qsmp** compiler option.

Syntax

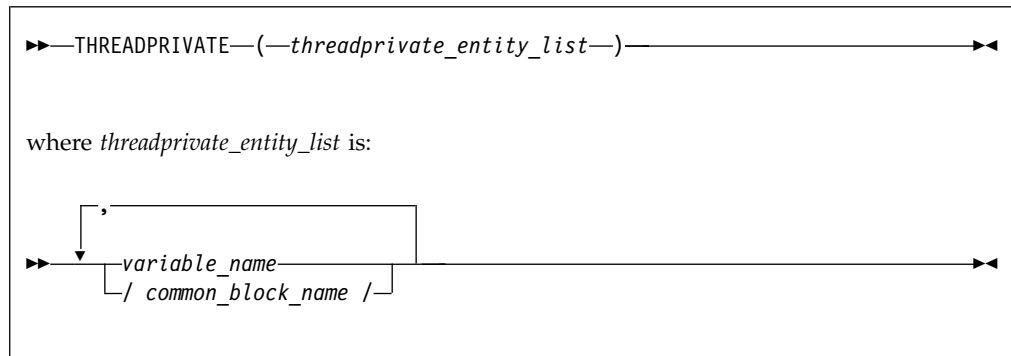

common_block_name
is the name of a common block to be made private to a thread.

variable_name
is the name of a variable to be made private to a thread.

Rules

You cannot specify a **THREADPRIVATE** variable, common block, or the variables that comprise that common block in a **PRIVATE**, **FIRSTPRIVATE**, **LASTPRIVATE**, **SHARED**, or **REDUCTION** clause.

A **THREADPRIVATE** variable must have the **SAVE** attribute. For variables or common blocks declared in the scope of a module, the **SAVE** attribute is implied. If you declare the variable outside of the scope of the module, the **SAVE** attribute must be specified.

In **THREADPRIVATE** directives, you can only specify named variables and named common blocks.

A variable can only appear in a **THREADPRIVATE** directive in the scope in which it is declared, and a **THREADPRIVATE** variable or common block may only appear once in a given scope. The variable must not be an element of a common block, or be declared in an **EQUIVALENCE** statement.

You cannot specify the same *common_block_name* for both a **THREADPRIVATE** directive and a **THREADLOCAL** directive.

All rules and constraints that apply to named common blocks also apply to common blocks declared as **THREADPRIVATE**. See the **COMMON** statement in the *XL Fortran Language Reference*.

If you declare a common block as **THREADPRIVATE** in one scoping unit, you must declare it as **THREADPRIVATE** in all other scoping units in which it is declared.

If you declare a **THREADPRIVATE** variable or a **THREADPRIVATE** common block with the **BIND** attribute, you must specify the corresponding C entities in a **THREADPRIVATE** directive in the C program. See Example 4 for the detailed usage information.

On entry into any parallel region, a **THREADPRIVATE** variable, or a variable in a **THREADPRIVATE** common block specified in a **COPYIN** clause is subject to the criteria stated in the **Rules** section for the **COPYIN** clause.

On entry into the first parallel region of the program, **THREADPRIVATE** variables or variables within a **THREADPRIVATE** common block not specified in a **COPYIN** clause are subject to the following criteria:

- If the variable has the **ALLOCATABLE** attribute, the initial allocation status of each copy of that variable is not currently allocated.
- If the variable has the **POINTER** attribute, and that pointer is disassociated through either explicit or default initialization, the association status of each copy of that variable is disassociated. Otherwise, the association status of the pointer is undefined.
- If the variable has neither the **ALLOCATABLE** nor the **POINTER** attribute and is defined through either explicit or default initialization, then each copy of that variable is defined. If the variable is undefined, then each copy of that variable is undefined.

On entry into subsequent parallel regions of the program, **THREADPRIVATE** variables, or variables within a **THREADPRIVATE** common block not specified in a **COPYIN** clause, are subject to the following criteria:

- If you are using the **OMP_DYNAMIC** environment variable, or the **omp_set_dynamic** subroutine to enable dynamic threads and:
 - If the number of threads is smaller than the number of threads in the previous region, and if a **THREADPRIVATE** object is referenced in both regions, then threads with the same thread number in their respective regions will reference the same copy of that variable.
 - If the number of threads is larger than the number of threads in the previous region, then the definition and association status of a **THREADPRIVATE** object is undefined, and the allocation status is undefined.

- If dynamic threads are disabled, the definition, association, or allocation status and definition, if the thread's copy of the variable was defined, is retained.

You cannot access the name of a common block by use association or host association. Thus, a named common block can only appear on a **THREADPRIVATE** directive if the common block is declared in the scoping unit that contains the **THREADPRIVATE** directive. However, you can access the variables in the common block by use association or host association. For more information, see Host and Use association in the *XL Fortran Language Reference*.

The **-qinit=f90ptr** compiler option does not affect pointers that you have declared in a **THREADPRIVATE** common block.

The **DEFAULT** clause does not affect variables in **THREADPRIVATE** common blocks.

Examples

Example 1: In this example, the **PARALLEL DO** directive invokes multiple threads that call **SUB1**. The common block **BLK** in **SUB1** shares the data that is specific to the thread with subroutine **SUB2**, which is called by **SUB1**.

```

PROGRAM TT
  INTEGER :: I, B(50)

!$OMP PARALLEL DO SCHEDULE(STATIC, 10)
  DO I=1, 50
    CALL SUB1(I, B(I))      ! Multiple threads call SUB1.
  ENDDO
END PROGRAM TT

SUBROUTINE SUB1(J, X)
  INTEGER :: J, X, A(100)
  COMMON /BLK/ A
!$OMP THREADPRIVATE(/BLK/) ! Array a is private to each thread.
! ...
  CALL SUB2(J)
  X = A(J) + A(J + 50)
! ...
END SUBROUTINE SUB1

SUBROUTINE SUB2(K)
  INTEGER :: C(100)
  COMMON /BLK/ C
!$OMP THREADPRIVATE(/BLK/)
! ...
  C = K
! ...
! Since each thread has its own copy of
! common block BLK, the assignment of
! array C has no effect on the copies of
! that block owned by other threads.
END SUBROUTINE SUB2

```

Example 2: In this example, each thread has its own copy of the common block **ARR** in the parallel section. If one thread initializes the common block variable **TEMP**, the initial value is not visible to other threads.

```

PROGRAM ABC
  INTEGER :: I, TEMP(100), ARR1(50), ARR2(50)
  COMMON /ARR/ TEMP
!$OMP THREADPRIVATE(/ARR/)
  INTERFACE
    SUBROUTINE SUBS(X)

```

```

        INTEGER :: X(:)
        END SUBROUTINE
    END INTERFACE
! ...
!$OMP PARALLEL SECTIONS
!$OMP SECTION
! ...
        TEMP(1:100:2) = -1
        TEMP(2:100:2) = 2
        CALL SUBS(ARR1)
! ...
!$OMP SECTION
! ...
        TEMP(1:100:2) = 1
        TEMP(2:100:2) = -2
        CALL SUBS(ARR2)
! ...
!$OMP END PARALLEL SECTIONS
! ...
        PRINT *, SUM(ARR1), SUM(ARR2)
    END PROGRAM ABC

    SUBROUTINE SUBS(X)
        INTEGER :: K, X(:), TEMP(100)
        COMMON /ARR/ TEMP
!$OMP THREADPRIVATE(/ARR/)
! ...
        DO K = 1, UBOUND(X, 1)
            X(K) = TEMP(K) + TEMP(K + 1)
! The thread is accessing its
! own copy of
! the common block.
        ENDDO
! ...
    END SUBROUTINE SUBS

```

The expected output for this program is:

```
50 -50
```

Example 3: In the following example, local variables outside of a common block are declared as **THREADPRIVATE**.

```

    MODULE MDL
        INTEGER :: A(2)
        INTEGER, POINTER :: P
        INTEGER, TARGET :: T
!$OMP THREADPRIVATE(A, P)
    END MODULE MDL

    PROGRAM MVAR
    USE OMP_LIB
    USE MDL

    INTEGER :: I

    CALL OMP_SET_NUM_THREADS(2)
    A = (/1, 2/)
    T = 4
    P => T

!$OMP PARALLEL PRIVATE(I) COPYIN(A, P)
    I = OMP_GET_THREAD_NUM()
    IF (I .EQ. 0) THEN
        A(1) = 100
        T = 5
    ELSE IF (I .EQ. 1) THEN

```

```

        A(2) = 200
    END IF
!$OMP END PARALLEL

!$OMP PARALLEL PRIVATE(I)
    I = OMP_GET_THREAD_NUM()
    IF (I .EQ. 0) THEN
        PRINT *, 'A(2) = ', A(2)
    ELSE IF (I .EQ. 1) THEN
        PRINT *, 'A(1) = ', A(1)
        PRINT *, 'P => ', P
    END IF
!$OMP END PARALLEL

    END PROGRAM MVAR

```

If dynamic threads mechanism is disabled, the expected output is:

```

A(2) = 2
A(1) = 1
P => 5
or
A(1) = 1
P => 5
A(2) = 2

```

Example 4: In this example, the C interoperable variable **NUMVAR** is declared as **THREADPRIVATE**. Changes made by thread 1 to the private copy of **NUMVAR** does not affect the copy of the master thread.

Fortran source file

```

    MODULE M
        USE, INTRINSIC :: ISO_C_BINDING
        INTEGER(C_INT), BIND(C) :: NUMVAR(10)
!$OMP THREADPRIVATE(NUMVAR)
    END MODULE M

    PROGRAM P
        USE M
        USE OMP_LIB
        INTERFACE
            SUBROUTINE INIT_NUM() BIND(C)
            END SUBROUTINE INIT_NUM

            SUBROUTINE PRINT_NUM() BIND(C)
            END SUBROUTINE PRINT_NUM
        END INTERFACE
        INTEGER TNUM
        CALL INIT_NUM()

        CALL OMP_SET_NUM_THREADS(2)

!$OMP PARALLEL COPYIN(NUMVAR)
        TNUM = OMP_GET_THREAD_NUM()
        IF (TNUM .EQ. 0) THEN
            ! PROCESS NUMVAR
        ELSE IF (TNUM .EQ. 1) THEN
            NUMVAR = NUMVAR * 4
            CALL PRINT_NUM()
            ! PROCESS NUMVAR
        END IF
!$OMP END PARALLEL
        CALL PRINT_NUM()
    END PROGRAM P

```

Related reference:



See COMMON in the Language Reference

“OMP_DYNAMIC” on page 87

“omp_set_dynamic(enable_expr)” on page 198

“PARALLEL / END PARALLEL” on page 121

“PARALLEL DO / END PARALLEL DO” on page 123

“PARALLEL SECTIONS / END PARALLEL SECTIONS” on page 127

WORKSHARE / END WORKSHARE

Purpose

The **WORKSHARE** directive allows you to parallelize the execution of array operations. A **WORKSHARE** directive divides the tasks associated with an enclosed block of code into *units of work*. When a team of threads encounters a **WORKSHARE** directive, the threads in the team share the tasks, so that each *unit of work* executes exactly once.

The **WORKSHARE** directive only takes effect if you specify the **-qsmp** compiler option.

Syntax

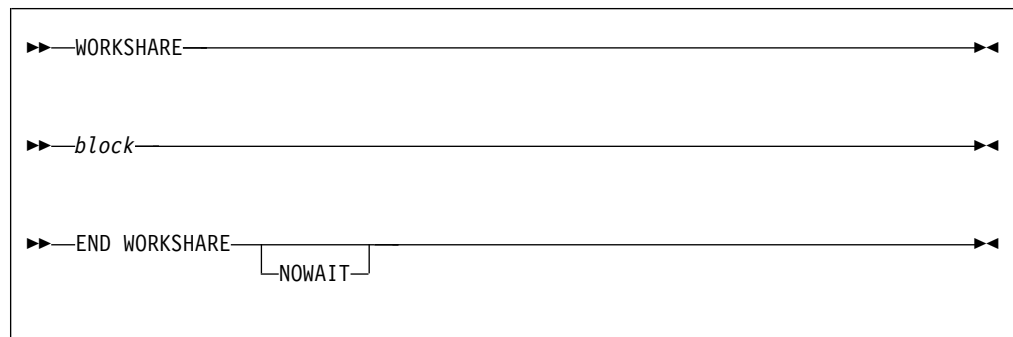

block is a structured block of statements that allows work sharing within the lexical extent of the **WORKSHARE** construct. The execution of statements are synchronized so that statements whose result is a dependent on another statement are evaluated before that result is required. The *block* can contain any of the following:

- Array assignment statements
- **ATOMIC** directives
- **CRITICAL** constructs
- **FORALL** constructs
- **FORALL** statements
- **PARALLEL** constructs
- **PARALLEL DO** constructs
- **PARALLEL SECTION** constructs
- **PARALLEL WORKSHARE** constructs
- Scalar assignment statements
- **WHERE** constructs
- **WHERE** statements

The transformational intrinsic functions you can use as part of an array operation are:

- ALL
- ANY
- COUNT
- CSHIFT
- DOT_PRODUCT
- EOSHIFT
- MATMUL
- MAXLOC
- MAXVAL
- MINLOC
- MINVAL
- PACK
- PRODUCT
- RESHAPE
- SPREAD
- SUM
- TRANSPOSE
- UNPACK

The *block* can also contain statements bound to lexically enclosed **PARALLEL** constructs. These statements are not restricted.

Any user-defined function calls within the *block* must be elemental.

Statements enclosed in a **WORKSHARE** directive are divided into *units of work*. The definition of a *unit of work* varies according to the statement evaluated. A *unit of work* is defined as follows:

- **Array expressions:** Evaluation of each element of an array expression is a *unit of work*. Any of the transformational intrinsic functions listed above may be divided into any number of *units of work*.
- **Assignment statements:** In an array assignment statement, the assignment of each element in the array is a *unit of work*. For scalar assignment statements, the assignment operation is a *unit of work*.
- **Constructs:** Evaluation of each **CRITICAL** construct is a *unit of work*. Each **PARALLEL** construct contained within a **WORKSHARE** construct is a single *unit of work*. New teams of threads execute the statements contained within the lexical extent of the enclosed **PARALLEL** constructs. In **FORALL** constructs or statements, the evaluation of the mask expression, expressions occurring in the specification of the iteration space, and the masked assignments are *units of work*. In **WHERE** constructs or statements, the evaluation of the mask expression and the masked assignments are *units of work*.
- **Directives:** The update of each scalar variable for an **ATOMIC** directive and its assignments is a *unit of work*.
- **ELEMENTAL functions:** If the argument to an **ELEMENTAL** function is an array, then the application of the function to each element of an array is a *unit of work*.

If none of the above definitions apply to a statement within the *block*, then that statement is a *unit of work*.

Rules

In order to ensure that the statements within a **WORKSHARE** construct execute in parallel, the construct must be enclosed within a parallel region. Threads encountering a **WORKSHARE** construct outside the dynamic extent of a parallel region will evaluate the statements within the construct serially.

A **WORKSHARE** directive binds to the closest enclosing **PARALLEL** region if one exists.

You must not nest work-sharing regions that bind to the same **PARALLEL** region.

You must not specify a **WORKSHARE** directive within the **CRITICAL**, **MASTER**, or **ORDERED** regions.

You must not specify **BARRIER**, **MASTER**, or **ORDERED** directives within a **WORKSHARE** region.

If an array assignment, scalar assignment, a masked array assignment or a **FORALL** assignment assigns to a private variable in the *block*, the result is undefined.

If an array expression in the *block* references the value, association status or allocation status of private variables, the value of the expression is undefined unless each thread computes the same value.

If you do not specify a **NO WAIT** clause at the end of a **WORKSHARE** construct, a **BARRIER** directive is implied.

A **WORKSHARE** construct must be encountered by all threads in the team or by none at all.

Examples

Example 1: In the following example, the **WORKSHARE** directive evaluates the masked expressions in parallel.

```
!$OMP WORKSHARE
  FORALL (I = 1 : N, AA(1, I) == 0) AA(1, I) = I
  BB = TRANSPOSE(AA)
  CC = MATMUL(AA, BB)
!$OMP ATOMIC
  S = S + SUM(CC)
!$OMP END WORKSHARE
```

Example 2: The following example includes a user defined **ELEMENTAL** as part of a **WORKSHARE** construct.

```
!$OMP WORKSHARE
  WHERE (AA(1, :) /= 0.0) AA(1, :) = 1 / AA(1, :)
  DD = TRANS(AA(1, :))
!$OMP END WORKSHARE

ELEMENTAL REAL FUNCTION TRANS(ELM) RESULT(RES)
  REAL, INTENT(IN) :: ELM
  RES = ELM * ELM + 4
END FUNCTION
```

Related reference:

“**ATOMIC**” on page 102

“**BARRIER**” on page 108

“**CRITICAL / END CRITICAL**” on page 109

“**PARALLEL WORKSHARE / END PARALLEL WORKSHARE**” on page 130

 See `-qsmp` in the Compiler Reference

Data sharing attribute rules

The rules of data sharing attributes determine the attributes of variables that are referenced in **PARALLEL** and **TASK** directives, and work-sharing regions.

Data sharing attribute rules for variables referenced in a construct

The data sharing attributes of variables that are referenced in a construct can be classified into the following categories:

- Predetermined data sharing attributes
- Explicitly determined data sharing attributes
- Implicitly determined data sharing attributes

Specifying a variable in a **FIRSTPRIVATE**, **LASTPRIVATE**, or **REDUCTION** clause of an enclosed construct initiates an implicit reference to the variable in the enclosing construct. Such implicit references also follow the data sharing attribute rules.

Some variables and objects have predetermined data sharing attributes as follows:

- Variables and common blocks specified in the **THREADPRIVATE** directive are threadprivate.
- The loop iteration variables in the associated **DO** loops of a **DO** or **PARALLEL DO** construct are private.
- Loop iteration variables for a sequential loop in a **PARALLEL** or **TASK** construct are private in the innermost such construct that encloses the loop.
- Implied-**DO** indices and **FORALL** indices are private.
- Integer pointees inherit the data sharing attributes of the storage with which their integer pointers are associated.
- Assumed-size arrays are shared.

Variables with predetermined data sharing attributes cannot be specified in data sharing attribute clauses. However, in the following situations, specifying a predetermined variable in a data sharing attribute clause is allowed and overrides the variable's predetermined data sharing attributes.

- The loop iteration variables in the associated **DO** loops of a **DO** or **PARALLEL DO** construct can be specified in a **PRIVATE** or **LASTPRIVATE** clause.
- Variables used as loop iteration variables in sequential loops within a **PARALLEL** or **TASK** construct can be specified in data sharing clauses on the construct itself, and on enclosed constructs, subject to other restrictions.
- Assumed-size arrays can be specified in a **SHARED** clause.

Variables that meet the following conditions have explicitly determined data sharing attributes:

- The variables are referenced in a construct.
- The variables are specified in a data sharing attribute clause on the construct.

Variables that meet all the following conditions have implicitly determined data sharing attributes:

- The variables are referenced in a construct.
- The variables do not have predetermined data sharing attributes.
- The variables are not specified in a data sharing attribute clause on the construct.

Rules for variables that have implicitly determined data sharing attributes are as follows:

- In a **PARALLEL** or **TASK** construct, the data sharing attributes of the variables are determined by the **DEFAULT** clause, if present.
- In a **PARALLEL** construct, if no **DEFAULT** clause is present, the variables are shared.
- For constructs other than **TASK**, if no **DEFAULT** clause is present, the variables inherit their data sharing attributes from the enclosing context.
- In a **TASK** construct, if no **DEFAULT** clause is present, a variable that is determined to be shared in the enclosing context by all implicit tasks bound to the current team is shared.
- In an orphaned **TASK** construct, if no **DEFAULT** clause is present, dummy arguments are **firstprivate**.
- In a **TASK** construct, if no **DEFAULT** clause is present, variables whose data sharing attributes are not determined by the rules above are **firstprivate**.

Data sharing attribute rules for variables referenced in a region but not in a construct

The data sharing attributes of variables that are referenced in a region, but not in a construct, are determined as follows:

- For local variables declared in called routines in the region, if the variables have the **save** attribute or are data initialized, then they are shared unless they are specified in a **THREADPRIVATE** directive.
- Variables that belong to common blocks, or declared in modules, and referenced in called procedures in the region are shared unless they are specified in a **THREADPRIVATE** directive.
- Dummy arguments of called procedures in the region that are passed by reference inherit the data sharing attributes of the associated actual argument.
- Integer pointees inherit the data sharing attribute of the storage with which their integer pointers are associated.
- Implied-**DO** indices, **FORALL** indices, and other local variables declared in procedures in the region are private.

Directive clauses

You can use directive clauses to specify additional information to directives.

Global rules for directive clauses

You must not specify a variable or common block name more than once in a clause.

A variable, common block name, or variable name that is a member of a common block must not appear in more than one clause on the same directive, with the following exceptions:

- You can define a named common block or named variable as **FIRSTPRIVATE** and **LASTPRIVATE** for the same directive.
- A variable appearing in a **NUM_THREADS** clause can appear in another clause for the same directive.
- A variable appearing in a **IF** clause can appear in another clause for the same directive.

If you do not specify a clause that changes the scope of a variable, the default scope for variables affected by a directive is **SHARED**.

A local variable with the **SAVE** or **STATIC** attribute declared in a procedure referenced a parallel region has an implicit **SHARED** attribute. A local variable without the **SAVE** or **STATIC** attribute declared in a procedure referenced a parallel region has an implicit **PRIVATE** attribute.

Members of common blocks and variables of modules declared in a procedure referenced within the dynamic extent of a parallel region have an implicit **SHARED** attribute, unless they are **THREADLOCAL** or **THREADPRIVATE** common blocks and module variables.

While a parallel or work-sharing construct is running, a variable or variable subobject used in a **PRIVATE**, **FIRSTPRIVATE**, **LASTPRIVATE** or **REDUCTION** clause of the directive must not be referenced, become defined, become undefined, have its association status or allocation status changed, or appear as an actual argument:

- In a scoping unit other than the one in which the directive construct appears
- In a variable format expression

You can declare a variable as **PRIVATE**, **FIRSTPRIVATE**, **LASTPRIVATE**, or **REDUCTION**, even if that variable is already storage associated with other variables. Storage association may exist for variables declared in **EQUIVALENCE** statements or in **COMMON** blocks. If a variable is storage associated with a **PRIVATE**, **FIRSTPRIVATE**, **LASTPRIVATE**, or **REDUCTION** variable, then:

- The contents, allocation status and association status of the variable that is storage associated with the **PRIVATE**, **FIRSTPRIVATE**, **LASTPRIVATE** or **REDUCTION** variable are undefined on entry to the parallel construct.
- The allocation status, association status and the contents of the associated variable become undefined if you define the **PRIVATE**, **FIRSTPRIVATE**, **LASTPRIVATE** or **REDUCTION** variable or if you define that variable's allocation or association status.
- The allocation status, association status and the contents of the **PRIVATE**, **FIRSTPRIVATE**, **LASTPRIVATE** or **REDUCTION** variable become undefined if you define the associated variable or if you define the associated variable's allocation or association status.

Pointers and OpenMP API

OpenMP API allows a variable or variable subobject of a **PRIVATE** clause to have the **POINTER** or **ALLOCATABLE** attribute. The association status of the pointer is undefined at thread creation and when the thread is destroyed.

See the following topics for more information about the directive clauses:

COLLAPSE	FIRSTPRIVATE	PRIVATE
COPYIN	LASTPRIVATE	REDUCTION
COPYPRIVATE	NUM_THREADS	SCHEDULE
DEFAULT	ORDERED	SHARED
IF		UNTIED

COLLAPSE

Purpose

Specifying the **COLLAPSE** clause allows you to parallelize multiple loops in a nest without introducing nested parallelism.

Syntax

```
▶▶—COLLAPSE—(—n—)————▶▶
```

n is a positive constant integer expression

Rules

- Only one collapse clause is allowed on a worksharing **DO** or **PARALLEL DO** directive
- The specified number of loops must be present lexically. That is, none of the loops can be in a called subroutine.
- The loops must form a rectangular iteration space and the bounds and stride of each loop must be invariant over all the loops.
- If the loop indices are of different size, the index with the largest size will be used for the collapsed loop.
- The loops must be perfectly nested; that is, there is no intervening code nor any OpenMP directive between the loops which are collapsed.
- The associated do-loops must be structured blocks. Their execution must not be terminated by an **EXIT** statement.
- If multiple loops are associated with the loop construct, only an iteration of the innermost associated loop may be curtailed by a **CYCLE** statement. If multiple loops are associated with the loop construct, there must be no branches to any of the loop termination statements except for the innermost associated loop.

Ordered construct

During execution of an iteration of a loop or a loop nested within a loop region, the executing thread must not execute more than one ordered region which binds to the same loop region. As a consequence, if multiple loops are associated with the loop construct by a collapse clause, the ordered construct has to be located inside all associated loops.

LASTPRIVATE clause

When a **LASTPRIVATE** clause appears on the directive that identifies a work-sharing construct, the value of each new list item from the sequentially last iteration of the associated loops is assigned to the original list item even if a collapse clause is associated with the loop

Other SMP and performance directives

The **STREAM_UNROLL**, **UNROLL**, **UNROLL_AND_FUSE**, and **NOUNROLL_AND_FUSE** directives cannot be used for any of the loops associated with the **COLLAPSE** clause loop nest. The **INDEPENDENT** directive can be used for any of the loops associated with the **COLLAPSE** clause.

Examples

In Example 1 and Example 2 the loops over *k* and *j* are collapsed and their iteration space is executed by all threads of the current team.

Example 1

```
!$omp do collapse(2) private(i,j,k)
do k = k1, ku, ks
  do j = j1, ju, js
```

```

        do i = il, iu, is
            call bar(a,i,j,k)
        enddo
    enddo
enddo
!$omp end do

```

Example 2

```

program test
!$omp parallel
!$omp do private(j,k) collapse(2) lastprivate(jlast, klast)
    do k = 1,2
        do j = 1,3
            jlast=j
            klast=k
        enddo
    enddo
!$omp end do
!$omp single
    print *, klast, jlast
!$omp end single
!$omp end parallel
end program test

```

Output:

```
2 3
```

Example 3

As both loops are collapsed into one, the ordered construct has to be inside all loops associated with the for construct. As an iteration may not execute more than one ordered region, this program would be incorrect without the collapse(2) clause.

```

program test
!$omp parallel num_threads(2)
!$omp do collapse(2) ordered private(j,k) schedule(static,3)
    do k = 1,3
        do j = 1,2
!$omp ordered
            print *, k, j
!$omp end ordered
        enddo
    enddo
!$omp end do
!$omp end parallel
end program test

```

Output:

```
1 1
1 2
2 1
2 2
3 1
3 2
```

Related reference:

ORDERED / END ORDERED

DO / END DO

PARALLEL DO / END PARALLEL DO

COPYIN

Purpose

If you specify the **COPYIN** clause, the master thread's copy of each variable, or common block declared in the *copyin_entity_list* is duplicated at the beginning of a parallel region. Each thread in the team that will execute within that parallel region receives a private copy of all entities in the *copyin_entity_list*. All variables declared in the *copyin_entity_list* must be **THREADPRIVATE** or members of a common block that appears in a **THREADPRIVATE** directive.

Syntax

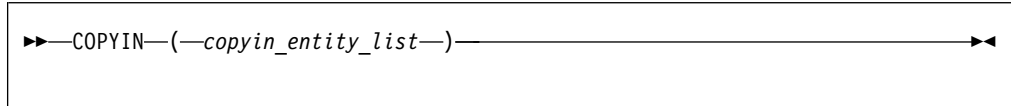

copyin_entity

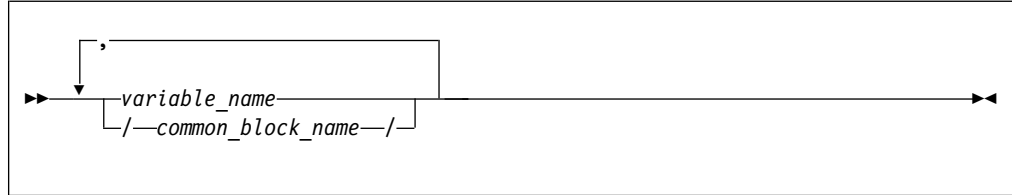

variable

is a **THREADPRIVATE** variable, or **THREADPRIVATE** variable in a common block.

common_block_name

is a **THREADPRIVATE** common block name.

Rules

If you specify a **COPYIN** clause, you cannot:

- specify the same entity name more than once in a *copyin_entity_list*.
- specify the same entity name in separate **COPYIN** clauses on the same directive.
- specify both a common block name and any variable within that same named common block in a *copyin_entity_list*.
- specify both a common block name and any variable within that same named common block in different **COPYIN** clauses on the same directive.
- specify a variable that contains **ALLOCATABLE** components.

When the master thread of a team of threads reaches a directive containing the **COPYIN** clause, each thread's private copy of a variable or common block specified in the **COPYIN** clause will have the same value as the master thread's copy.

On entry into any parallel region, a **THREADPRIVATE** variable, or a variable in a **THREADPRIVATE** common block is subject to the following criteria when declared in a **COPYIN** clause:

- If the variable has the **POINTER** attribute and the master thread's copy of the variable is associated with a target, then each copy of that variable is associated with the same target. If the master thread's pointer is disassociated, then each copy of that variable is disassociated. If the master thread's copy of the variable has an undefined association status, then each copy of that variable has an undefined association status.
- Each copy of a variable without the **POINTER** attribute becomes defined with the value of the master thread's copy as if by intrinsic assignment.

If an allocatable array is specified in a **COPYIN** clause and it is allocated on entry into a parallel region, each thread copy of that array must be allocated with the same bounds and rank.

Related reference:

PARALLEL / END PARALLEL
 PARALLEL DO / END PARALLEL DO
 PARALLEL SECTIONS / END PARALLEL SECTIONS
 PARALLEL WORKSHARE / END PARALLEL WORKSHARE

COPYPRIVATE

Purpose

If you specify the **COPYPRIVATE** clause, the value of a private variable or pointer to a shared object from one thread in a team is copied into the corresponding variables of all other threads in that team. If the variable in *copyprivate_entity_list* is not a pointer, then the corresponding variables of all threads within that team are defined with the value of that variable. If the variable is a pointer, then the corresponding variables of all threads within that team are defined with the association status of the pointer. Integer pointers and assumed-size arrays must not appear in *copyprivate_entity_list*.

Syntax

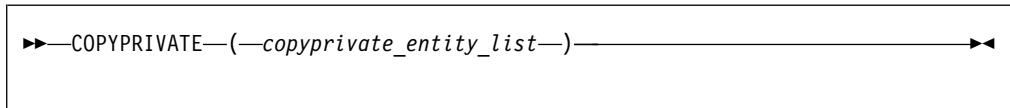

copyprivate_entity

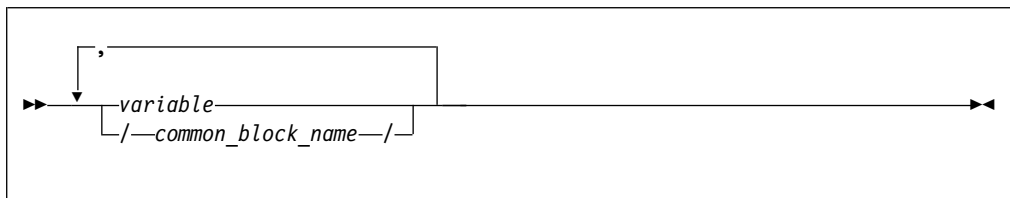

variable

is a private variable within the enclosing parallel region

common_block_name

is a **THREADPRIVATE** common block name

Rules

If a common block is part of the *copyprivate_entity_list*, then it must appear in a **THREADPRIVATE** directive. Furthermore, the **COPYPRIVATE** clause treats a common block as if all variables within its *object_list* were specified in the *copyprivate_entity_list*.

A **COPYPRIVATE** clause must occur on an **END SINGLE** directive at the end of a **SINGLE** construct. The compiler evaluates a **COPYPRIVATE** clause before any threads have passed the implied **BARRIER** directive at the end of that construct. The variables you specify in *copyprivate_entity_list* must not appear in a **PRIVATE** or **FIRSTPRIVATE** clause for the **SINGLE** construct. If the **END SINGLE** directive occurs within the dynamic extent of a parallel region, the variables you specify in *copyprivate_entity_list* must be private within that parallel region.

A **COPYPRIVATE** clause must not appear on the same **END SINGLE** directive as a **NOWAIT** clause.

A **THREADLOCAL** common block, or members of that common block, are not permitted as part of a **COPYPRIVATE** clause.

If an allocatable array appears on a **COPYPRIVATE** clause, it must have an allocation status of allocated with the same bounds and rank in all threads that are affected by the **COPYPRIVATE** clause.

Related reference:

SINGLE / **END SINGLE**

DEFAULT

Purpose

If you specify the **DEFAULT** clause, all variables in the lexical extent of the parallel construct will have a scope attribute of *default_scope_attr*.

If you specify **DEFAULT(NONE)**, there is no default scope attribute. Therefore, you must explicitly list each variable you use in the lexical extent of the parallel construct in a data scope attribute clause on the parallel construct, unless the variable is:

- **THREADPRIVATE**
- A member of a **THREADPRIVATE** common block.
- A pointee
- A loop iteration variable used only as a loop iteration variable for:
 - Sequential loops in the lexical extent of the parallel region, or,
 - Parallel do loops that bind to the parallel region
- A variable that is only used in work-sharing constructs that bind to the parallel region, and is specified in a data scope attribute clause for each of the work-sharing constructs.

The **DEFAULT** clause specifies that all variables in the parallel construct share the same default scope attribute of either **FIRSTPRIVATE**, **PRIVATE**, **SHARED**, or no default scope attribute.

Syntax

```
▶▶—DEFAULT—(—default_scope_attr—)————▶▶
```

default_scope_attr

is one of **FIRSTPRIVATE**, **PRIVATE**, **SHARED**, or **NONE**

Rules

If you specify **DEFAULT(NONE)** on a directive you must specify all named variables and all the leftmost names of referenced array sections, array elements, structure components, or substrings in the lexical extent of the directive construct in a **FIRSTPRIVATE**, **LASTPRIVATE**, **PRIVATE**, **REDUCTION**, or **SHARED** clause.

If you specify **DEFAULT(FIRSTPRIVATE)** on a directive, all named variables and all leftmost names of referenced array sections, array elements, structure components, or substrings in the lexical extent of the directive construct, including common block and use associated variables, but excluding **POINTEEs** and **THREADLOCAL** common blocks, have a **FIRSTPRIVATE** attribute to a thread as if they were listed explicitly in a **FIRSTPRIVATE** clause.

If you specify **DEFAULT(PRIVATE)** on a directive, all named variables and all leftmost names of referenced array sections, array elements, structure components, or substrings in the lexical extent of the directive construct, including common block and use associated variables, but excluding **POINTEEs** and **THREADLOCAL** common blocks, have a **PRIVATE** attribute to a thread as if they were listed explicitly in a **PRIVATE** clause.

If you specify **DEFAULT(SHARED)** on a directive, all named variables and all leftmost names of referenced array sections, array elements, structure components, or substrings in the lexical extent of the directive construct, excluding **POINTEEs** have a **SHARED** attribute to a thread as if they were listed explicitly in a **SHARED** clause.

The default behavior will be **DEFAULT(SHARED)** if you do not explicitly indicate a **DEFAULT** clause on a directive.

Example for OpenMP

The following example demonstrates the use of **DEFAULT(NONE)** for OpenMP, and some of the rules for specifying the data scope attributes of variables in the parallel region.

```
PROGRAM MAIN
  COMMON /COMBLK/ abc(10), def

  ! The loop iteration variable, i, is not required to be
  ! in data scope attribute clause.
  $OMP PARALLEL DEFAULT(NONE) SHARED(ABC)

  ! def is specified on the work-sharing DO, and is not required to be
  ! specified in a data scope attribute clause on the parallel region.
  !$OMP DO FIRSTPRIVATE(def)
```

```

DO i = 1,10
  ABC(i) = def
END DO
!$OMP END PARALLEL
END PROGRAM

```

Related reference:

PARALLEL / END PARALLEL
 PARALLEL DO / END PARALLEL DO
 PARALLEL SECTIONS / END PARALLEL SECTIONS
 PARALLEL WORKSHARE / END PARALLEL WORKSHARE
 "TASK / END TASK" on page 140

FINAL

Purpose

The **FINAL** clause is used with the **TASK** directive. If you specify a **FINAL** clause and the *scalar_logical_expr* evaluates to **.TRUE.**, the generated task is a final task. All task constructs encountered inside a final task create final and included tasks.

Syntax

▶▶—FINAL—(—*scalar_logical_expr*—)————▶▶

Rules

You can specify only one **FINAL** clause on the **TASK** directive.

Related reference

"TASK / END TASK" on page 140

FIRSTPRIVATE

Purpose

If you use the **FIRSTPRIVATE** clause, each thread has its own initialized local copy of the variables and common blocks in *data_scope_entity_list*.

The **FIRSTPRIVATE** clause can be specified for the same variables as the **PRIVATE** clause, and functions in a manner similar to the **PRIVATE** clause. The exception is the status of the variable upon entry into the directive construct; the **FIRSTPRIVATE** variable exists and is initialized for each thread entering the directive construct.

Syntax

▶▶—FIRSTPRIVATE—(—*data_scope_entity_list*—)————▶▶

Rules

A variable in a **FIRSTPRIVATE** clause must not be any of the following elements:

- A pointee
- An assumed-size array
- A **THREADLOCAL** common block
- A **THREADPRIVATE** common block or its members
- A **THREADPRIVATE** variable
- An allocatable scalar object

You cannot specify a variable in a **FIRSTPRIVATE** clause of a parallel construct if both the following conditions are true:

- The variable appears in a namelist statement, variable format expression or in an expression for a statement function definition.
- You reference the statement function, the variable format expression through formatted I/O, or the namelist through namelist I/O, within the parallel construct.

For a variable specified in the **FIRSTPRIVATE** clause, the status of the private copies is determined as follows:

- If the variable has the **POINTER** attribute, the private copies of the **FIRSTPRIVATE** variable receive the same association status as the original copy as if by pointer assignment.
- If the variable does not have the **POINTER** attribute, the initialization of the private copies occurs as if by intrinsic assignment. However, if the original variable is not currently allocated, the private copies have the same allocation status as the original copy.

If an allocatable array appears on a **FIRSTPRIVATE** clause, it must have an allocation status of allocated upon entrance into the parallel construct that contains the **FIRSTPRIVATE** clause.

When individual members of a common block are privatized, the storage of the specified variable is no longer associated with the storage of the common block.

Any variable that is storage associated with a **FIRSTPRIVATE** variable is undefined on entrance into the parallel construct.

If one of the entities involved in an asynchronous I/O operation is a **FIRSTPRIVATE** variable, a subobject of a **FIRSTPRIVATE** variable, or a pointer that is associated with a **FIRSTPRIVATE** variable, the matching implied wait or **WAIT** statement must be executed before the end of the thread.

If a directive construct contains a **FIRSTPRIVATE** argument to a Message Passing Interface (MPI) routine performing non-blocking communication, the MPI communication must complete before the end of the construct.

Related reference:

DO / END DO

PARALLEL / END PARALLEL

PARALLEL DO / END PARALLEL DO

PARALLEL SECTIONS / END PARALLEL SECTIONS

PARALLEL WORKSHARE / END PARALLEL WORKSHARE

SECTIONS / END SECTIONS
SINGLE / END SINGLE
"TASK / END TASK" on page 140

IF

Purpose

If you specify the **IF** clause, the runtime environment evaluates whether the *scalar_logical_expression* is true or false. If *scalar_logical_expression* is:

- true, the block is run in parallel.
- false, the containing region is suspended and the generated task is immediately run as though it is in a distinct task region.

Note that for the **TASK** directive, if the IF clause is evaluated to true, the block is not required to run in parallel.

Syntax

```
▶▶—IF—(—scalar_logical_expression—)————▶▶
```

Rules

The **IF** clause can be used in the **PARALLEL**, **PARALLEL DO**, **PARALLEL SECTIONS**, **PARALLEL WORKSHARE**, and **TASK** directives.

The **IF** clause may appear at most once in any directive.

By default, a nested parallel loop is serialized, regardless of the setting of the **IF** clause. You can change this default by using the **-qsmp=nested_par** compiler option.

An **IF** expression is evaluated outside of the context of the parallel construct. Any function reference in the **IF** expression must not have side effects.

Related reference:

"PARALLEL / END PARALLEL" on page 121

"PARALLEL DO / END PARALLEL DO" on page 123

"PARALLEL SECTIONS / END PARALLEL SECTIONS" on page 127

"PARALLEL WORKSHARE / END PARALLEL WORKSHARE" on page 130

"TASK / END TASK" on page 140

LASTPRIVATE

Purpose

If you use the **LASTPRIVATE** clause, each variable and common block in *data_scope_entity_list* is **PRIVATE**, and the last value of each variable in *data_scope_entity_list* can be referred to outside of the construct of the directive. If you use the **LASTPRIVATE** clause with **DO** or **PARALLEL DO**, the last value is the value of the variable after the last sequential iteration of the loop. If you use the **LASTPRIVATE** clause with **SECTIONS** or **PARALLEL SECTIONS**, the last value is the value of the variable after the last **SECTION** of the construct. If the

last iteration of the loop or last section of the construct does not define a **LASTPRIVATE** variable, the variable is undefined after the loop or construct.

The **LASTPRIVATE** clause functions in a manner similar to the **PRIVATE** clause and you should specify it for variables that match the same criteria. The exception is in the status of the variable on exit from the directive construct. The compiler determines the last value of the variable, and takes a copy of that value which it saves in the named variable for use after the construct. A **LASTPRIVATE** variable is undefined on entry to the construct if it is not a **FIRSTPRIVATE** variable.

Syntax

```
▶▶—LASTPRIVATE—(—data_scope_entity_list—)————▶▶
```

Rules

A variable in a **LASTPRIVATE** clause must not be any of the following elements:

- A pointee
- An allocatable scalar object
- An assumed-size array
- A **THREADLOCAL** common block
- A **THREADPRIVATE** common block or its members
- A **THREADPRIVATE** variable

You cannot specify a variable in a **LASTPRIVATE** clause of a parallel construct if both the following conditions are true:

- The variable appears in a namelist statement, variable format expression or in an expression for a statement function definition.
- You reference the statement function, the variable format expression through formatted I/O, or the namelist through namelist I/O, within the parallel construct.

A **LASTPRIVATE** variable must be definable.

For a variable specified in a **LASTPRIVATE** clause,

- If the variable has the **POINTER** attribute, the original variable is updated as if by pointer assignment.
- If the variable does not have the **POINTER** attribute, the original variable is updated as if by intrinsic assignment.

If an allocatable array appears on a **LASTPRIVATE** clause, its allocation status must be allocated when it enters into the parallel construct that contains the **LASTPRIVATE** clause. The private copies of the **LASTPRIVATE** variable in the sequentially last iteration or lexically last section must have an allocation status of allocated. They must have the same bounds and rank as the corresponding **LASTPRIVATE** variable when they exit from that iteration or section.

When individual members of a common block are privatized, the storage of the specified variable is no longer associated with the storage of the common block.

Any variable that is storage associated with a **LASTPRIVATE** variable is undefined on entrance into the parallel construct.

If you specify a variable as **LASTPRIVATE** on a work-sharing directive, and you have specified a **NOWAIT** clause on that directive, you cannot use that variable between the end of the work-sharing construct and a **BARRIER** directive.

Variables that you specify as **LASTPRIVATE** to a parallel construct become defined at the end of the construct. If you have concurrent definitions or uses of **LASTPRIVATE** variables on multiple threads, you must ensure that the threads are synchronized at the end of the construct when the variables become defined. For example, if multiple threads encounter a **PARALLEL** construct with a **LASTPRIVATE** variable, you must synchronize the threads when they reach the **END PARALLEL** directive, because the **LASTPRIVATE** variable becomes defined at **END PARALLEL**. Therefore the whole **PARALLEL** construct must be enclosed within a synchronization construct.

If one of the entities involved in an asynchronous I/O operation is a **LASTPRIVATE**, a subobject of a **LASTPRIVATE** variable, or a pointer that is associated with a **LASTPRIVATE** variable, the matching implied wait or **WAIT** statement must be executed before the end of the thread.

If a directive construct contains a **LASTPRIVATE** argument to a Message Passing Interface (MPI) routine performing non-blocking communication, the MPI communication must complete before the end of that construct.

Example for OpenMP

The following example shows the proper use of a **LASTPRIVATE** variable after a **NOWAIT** clause.

```
!$OMP PARALLEL
!$OMP DO LASTPRIVATE(k)
DO i = 1,10
  k = i + 1
END DO

!$OMP END DO NOWAIT
k = ... **ERROR**      ! The reference to k must occur after a barrier.
!$OMP BARRIER
k = ...                ! this reference to k is valid.
!$OMP END PARALLEL
END
```

Related reference:

```
DO / END DO
PARALLEL DO / END PARALLEL DO
PARALLEL SECTIONS / END PARALLEL SECTIONS
SECTIONS / END SECTIONS
```

MERGEABLE

Purpose

The **MERGEABLE** clause is used with the **TASK** directive. If you specify a **MERGEABLE** clause and the generated task is an undeferred task or an included task, a merged task might be generated.

Syntax

```
▶▶—MERGEABLE—▶▶
```

Related reference

“TASK / END TASK” on page 140

NUM_THREADS

Purpose

The **NUM_THREADS** clause allows you to specify the number of threads used in a parallel region. Subsequent parallel regions are not affected. The **NUM_THREADS** clause takes precedence over the number of threads specified using the **omp_set_num_threads** library routine or the environment variable **OMP_NUM_THREADS**.

Syntax

```
▶▶—NUM_THREADS—(—scalar_integer_expression—)—▶▶
```

Rules

The value of *scalar_integer_expression* must be a positive integer. Evaluation of the expression occurs outside the context of the parallel region. Any function calls that appear in the expression and change the value of a variable referenced in the expression will have unspecified results.

If you are using the environment variable **OMP_DYNAMIC** to enable dynamic threads, *scalar_integer_expression* defines the maximum number of threads available in the parallel region.

You must specify the **omp_set_nested** library routine or set the **OMP_NESTED** environment variable when including the **NUM_THREADS** clause as part of a nested parallel regions; otherwise, the execution of that parallel region is serialized.

Related reference:

PARALLEL / END PARALLEL

PARALLEL DO / END PARALLEL DO

PARALLEL SECTIONS / END PARALLEL SECTIONS

PARALLEL WORKSHARE / END PARALLEL WORKSHARE

ORDERED

Purpose

Specifying the **ORDERED** clause on a work-sharing construct allows you to specify the **ORDERED** directive within the dynamic extent of a parallel loop.

Syntax

```
▶▶—ORDERED—◀◀
```

Rules

The **ORDERED** clause applies to the following directives:

- “DO / END DO” on page 111
- “PARALLEL DO / END PARALLEL DO” on page 123

Related reference:

“DO / END DO” on page 111

“PARALLEL DO / END PARALLEL DO” on page 123

PRIVATE

Purpose

If you specify the **PRIVATE** clause on one of the directives listed below, each thread in a team has its own uninitialized local copy of the variables and common blocks in *data_scope_entity_list*.

You should specify a variable in the **PRIVATE** clause if its value is calculated by a single thread and that value is not dependent on any other thread, if it is defined before it is used in the construct, and if its value is not used after the construct ends. Copies of the **PRIVATE** variable exist, locally, on each thread. Each thread receives its own uninitialized copy of the **PRIVATE** variable. All thread variables within the lexical extent of the directive construct have the **PRIVATE** attribute by default.

Syntax

```
▶▶—PRIVATE—(—data_scope_entity_list—)——▶▶
```

Rules

A variable in the **PRIVATE** clause must not be any of the following elements:

- A pointee
- An assumed-size array
- A **THREADLOCAL** common block
- A **THREADPRIVATE** common block or its members
- A **THREADPRIVATE** variable or the variable equivalenced with a **THREADPRIVATE** variable

You cannot specify a variable in a **PRIVATE** clause of a parallel construct if:

- the variable appears in a namelist statement, variable format expression or in an expression for a statement function definition, and,

- you reference the statement function, the variable format expression through formatted I/O, or the namelist through namelist I/O, within the parallel construct.

If one of the entities involved in an asynchronous I/O operation is a **PRIVATE** variable, a subobject of a **PRIVATE** variable, or a pointer that is associated with a **PRIVATE** variable, the matching implied wait or **WAIT** statement must be executed before the end of the thread.

When individual members of a common block are privatized, the storage of the specified variable is no longer associated with the storage of the common block.

A variable that appears in the **REDUCTION** clause of a parallel construct can also appear in a **PRIVATE** clause on a work-sharing construct.

If a directive construct contains a **PRIVATE** argument to a Message Passing Interface (MPI) routine performing non-blocking communication, the MPI communication must complete before the end of that construct.

A variable name in the *data_scope_entity_list* of the **PRIVATE** clause can be an allocatable array. If the allocatable array is allocated on entry to a parallel region, the private copies of the array has an allocation status of allocated and has the same rank and bounds as the **PRIVATE** variable. If the allocatable array is deallocated on entry to a parallel region, the private copies of the array has an allocation status of deallocated.

Local variables without the **SAVE** or **STATIC** attributes in referenced subprograms in the dynamic extent of a directive construct have an implicit **PRIVATE** attribute.

Examples for OpenMP

Example 1: The following example demonstrates the proper use of a **PRIVATE** variable that is used to define a statement function. A commented line shows the invalid use. Since *J* appears in a statement function, the statement function cannot be referenced within the parallel construct for which *J* is **PRIVATE**.

```
INTEGER :: arr(10), j = 17
ISTFNC() = j

!$OMP PARALLEL DO PRIVATE(j)
DO i = 1, 10
  j = i
  ! arr(i) = ISTFNC() **ERROR** A reference to ISTFNC would
  ! make the PRIVATE(J) clause invalid.
  ARR(i) = j
END DO
PRINT *, arr
END
```

Example 2: The following example demonstrates the use of allocatable arrays on a **PRIVATE** clause:

```
USE OMP_LIB
REAL, ALLOCATABLE :: temp(:, :)
REAL :: arr(4, 20, 20)
INTEGER :: thd

ALLOCATE(temp(20, 20))
!$OMP PARALLEL PRIVATE(thd, temp) NUM_THREADS(4)

! Private copies of "temp" are allocated with the same
```

```

! bounds and shape of the original "temp".
thd = OMP_GET_THREAD_NUM()
IF(MOD(thd, 2) .EQ. 0) THEN
  temp = RESHAPE((/i, i=1, 400/), (/20, 20/))
ELSE
  temp = RESHAPE((/i, i=1, 800, 2/), (/20, 20/))
ENDIF
arr(thd + 1, :, :) = temp

! Private copies of "temp" are deallocated.
!$OMP END PARALLEL
DEALLOCATE(temp)
END

```

Note: If the machine has less than 4 CPUs, you must set `OMP_THREAD_LIMIT=4`.

Example 3: The following example demonstrates the persistence of the original value of the **PRIVATE** variables after exit from a parallel region:

```

PROGRAM MAIN
  INTEGER :: i, j

  i = 1
  j = 2
!$OMP PARALLEL PRIVATE(i, j)
  i = 3
  j = j + 2
!$OMP END PARALLEL
  PRINT *, i, j           ! Output: 1 2
END PROGRAM

```

Related reference:

DO / END DO
 PARALLEL / END PARALLEL
 PARALLEL DO / END PARALLEL DO
 PARALLEL SECTIONS / END PARALLEL SECTIONS
 PARALLEL WORKSHARE / END PARALLEL WORKSHARE
 SECTIONS / END SECTIONS
 SINGLE / END SINGLE
 "TASK / END TASK" on page 140

PROC_BIND

Purpose

The **PROC_BIND** clause specifies a policy for binding and distributing threads to places within the current place partition.

Syntax

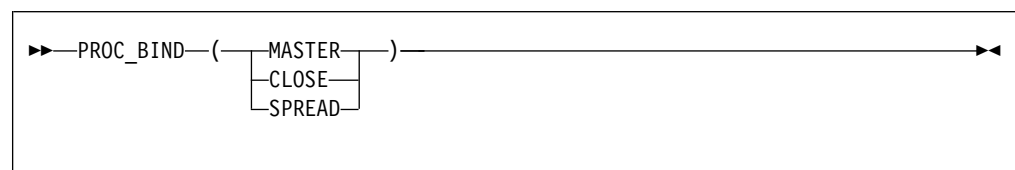

MASTER

Instructs the execution environment to assign every thread in the team to the same place as the master thread.

CLOSE

Instructs the execution environment to assign the threads to places that are close to the place of the parent's thread. The master thread executes on the parent's place. The remaining threads in the team execute on places from the place list consecutive from the parent's position in the list with wrap around.

SPREAD

Instructs the compiler to spread a set of T threads as evenly as possible among the P places of the parent's place partition at run time.

Rules

- At most one **PROC_BIND** clause can appear on the **PARALLEL** directive.
- If the **OMP_PROC_BIND** environment variable is not set to **FALSE**, the **PROC_BIND** clause overrides the first element in the **OMP_PROC_BIND** environment variable.
- If the **OMP_PROC_BIND** environment variable is set to **FALSE**, the **PROC_BIND** clause has no effect.

Related reference:

PARALLEL / END PARALLEL

PARALLEL SECTIONS / END PARALLEL SECTIONS

omp_get_proc_bind

Related information:

OMP_PROC_BIND

REDUCTION

Purpose

The **REDUCTION** clause updates named variables declared on the clause within the directive construct. Intermediate values of **REDUCTION** variables are not used within the parallel construct, other than in the updates themselves.

Syntax

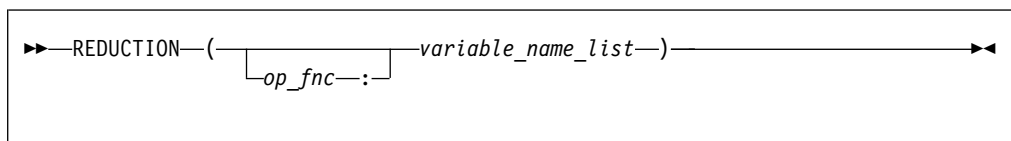

op_fnc is a *reduction_op* or a *reduction_function* that appears in all **REDUCTION** statements involving this variable. You must not specify more than one **REDUCTION** operator or function for a variable in the directive construct. To maintain OpenMP API compliance, you must specify *op_fnc* for the **REDUCTION** clause.

A **REDUCTION** statement can have one of the following forms:

\rightarrow *reduction_var_ref* = *expr* *reduction_op* *reduction_var_ref* \leftarrow
 \rightarrow *reduction_var_ref* = *reduction_var_ref* *reduction_op* *expr* \leftarrow
 \rightarrow *reduction_var_ref* = *reduction_function* (*expr*, *reduction_var_ref*) \leftarrow
 \rightarrow *reduction_var_ref* = *reduction_function* (*reduction_var_ref*, *expr*) \leftarrow

where:

reduction_var_ref
is a variable or subobject of a variable that appears in a **REDUCTION** clause

reduction_op
is one of the intrinsic operators: +, -, *, **.AND.**, **.OR.**, **.EQV.**, **.NEQV.**, or **.XOR.**
when *reduction_op* is an intrinsic operator, it should be the last operation performed on the right side.

reduction_function
is one of the intrinsic procedures: **MAX**, **MIN**, **IAND**, **IOR**, or **IEOR**.

expr should not contain references to *reduction_var_ref*

The canonical initialization value of each of the operators and intrinsics are shown in the following table. The actual initialization value will be consistent with the data type of your corresponding **REDUCTION** variable.

Intrinsic Operator	Initialization
+	0
*	1
-	0
.AND.	.TRUE.
.OR.	.FALSE.
.EQV.	.TRUE.
.NEQV.	.FALSE.
.XOR.	.FALSE.
Intrinsic Procedure	Initialization
MAX	Smallest representable number
MIN	Largest representable number
IAND	All bits on
IOR	0
IEOR	0

Rules

The following rules apply to **REDUCTION** statements:

- A variable in the **REDUCTION** clause must only occur in a **REDUCTION** statement within the directive construct on which the **REDUCTION** clause appears.
- The two *reduction_var_refs* that appear in a **REDUCTION** statement must be lexically identical.
- You cannot use the following form of the **REDUCTION** statement:
 $reduction_var_ref = expr\ operator\ reduction_var_ref$, where *operator* is any operator other than *reduction_op*.

When you specify individual members of a common block in a **REDUCTION** clause, the storage of the specified variable is no longer associated with the storage of the common block.

Any variable you specify in a **REDUCTION** clause of a work-sharing construct must be shared in the enclosing **PARALLEL** construct.

A variable that appears in the **REDUCTION** clause of a parallel construct can also appear in a **PRIVATE** clause on a work-sharing construct.

If you use a **REDUCTION** clause on a construct that has a **NOWAIT** clause, the **REDUCTION** variable remains undefined until a barrier synchronization has been performed to ensure that all threads have completed the **REDUCTION** clause.

A **REDUCTION** variable must not appear in a **FIRSTPRIVATE**, **PRIVATE**, or **LASTPRIVATE** clause of another construct within the dynamic extent of the construct in which it appeared as a **REDUCTION** variable.

If you specify *op_fnc* for the **REDUCTION** clause, each variable in the *variable_name_list* must be of intrinsic type. The variable can only appear in a **REDUCTION** statement within the lexical extent of the directive construct. You must specify *op_fnc* if the directive uses the *trigger_constant* **\$OMP**.

The **REDUCTION** clause specifies named variables that appear in reduction operations. The compiler will maintain local copies of such variables, but will combine them upon exit from the construct. The intermediate values of the **REDUCTION** variables are combined in random order, dependent on which threads finish their calculations first. Therefore, there is no guarantee that bit-identical results will be obtained from one parallel run to another. This is true even if the parallel runs use the same number of threads, scheduling type, and chunk size.

Variables that you specify as **REDUCTION** or **LASTPRIVATE** to a parallel construct become defined at the end of the construct. If you have concurrent definitions or uses of **REDUCTION** or **LASTPRIVATE** variables on multiple threads, you must ensure that the threads are synchronized at the end of the construct when the variables become defined. For example, if multiple threads encounter a **PARALLEL** construct with a **REDUCTION** variable, you must synchronize the threads when they reach the **END PARALLEL** directive, because the **REDUCTION** variable becomes defined at **END PARALLEL**. Therefore the whole **PARALLEL** construct must be enclosed within a synchronization construct.

If an allocatable array appears on a **REDUCTION** clause, it must have an allocation status of allocated upon entrance into the construct that contains the **REDUCTION** clause. Additionally, the private copies of the **REDUCTION** variable must not be deallocated or allocated within the region.

A variable in the **REDUCTION** clause must be of intrinsic type. A variable in the **REDUCTION** clause, or any element thereof, must not be any of the following:

- A pointee
- An assumed-size array
- A **THREADLOCAL** common block
- A **THREADPRIVATE** common block or its members
- A **THREADPRIVATE** variable
- An allocatable scalar object
- A Fortran 90 pointer

These rules describe the use of **REDUCTION** on OpenMP directives. If you are using the **REDUCTION** clause on the **INDEPENDENT** directive, see the **INDEPENDENT** directive in the *XL Fortran Language Reference* directive.

Related reference:

DO / END DO

PARALLEL / END PARALLEL

PARALLEL DO / END PARALLEL DO

PARALLEL SECTIONS / END PARALLEL SECTIONS

PARALLEL WORKSHARE / END PARALLEL WORKSHARE

SECTIONS / END SECTIONS

SCHEDULE

Purpose

You can use the **SCHEDULE** clause to specify the chunking method for parallelization. Work is assigned to threads in different manners depending on the scheduling type or chunk size used.

Syntax

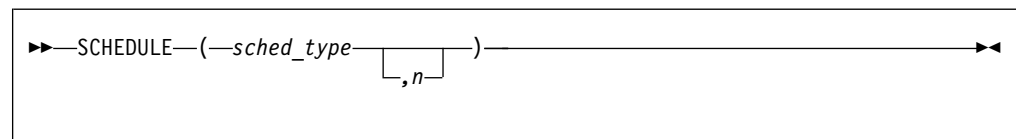

sched_type

is one of **AFFINITY**, **AUTO**, **DYNAMIC**, **GUIDED**, **RUNTIME**, or **STATIC**.

n

must be a positive scalar integer expression; do not specify *n* for the **AUTO** and **RUNTIME** schedule type. If you are using the *trigger_constant* **\$OMP**, do not specify the scheduling type **AFFINITY**.

AFFINITY

The iterations of a loop are initially divided into *number_of_threads* partitions, containing $\text{CEILING}(\text{number_of_iterations} / \text{number_of_threads})$ iterations. Each partition is initially assigned to a thread, and is then further subdivided into chunks containing *n* iterations, if *n* has been specified. If *n* has not been specified, then the chunks consist of $\text{CEILING}(\text{number_of_iterations_remaining_in_partition} / 2)$ loop iterations.

When a thread becomes free, it takes the next chunk from its initially assigned partition. If there are no more chunks in that partition, then the thread takes the next available chunk from a partition that is initially assigned to another thread.

Threads that are active will complete the work in a partition that is initially assigned to a sleeping thread.

Note: This scheduling type has been deprecated and might be removed in a future release. You can use the **GUIDED** scheduling type for a similar functionality.

AUTO

The compiler and runtime system choose the most appropriate mapping of iteration to threads for each loop.

DYNAMIC

If n has been specified, the iterations of a loop are divided into chunks containing n contiguous iterations each except for the last chunk. If n is not specified, the default chunk size is 1 iteration.

Chunks are assigned to threads on a "first-come, first-do" basis as threads become available. Chunks of the remaining work are assigned to available threads until all work has been assigned.

GUIDED

If you specify a value for n , the iterations of a loop are divided into chunks such that the size of each successive chunk is exponentially decreasing. n specifies the size of the smallest chunk, except possibly the last. If you do not specify a value for n , the default value is 1.

The size of the initial chunk is proportional to $\text{CEILING}(\text{number_of_iterations} / \text{number_of_threads})$ iterations. Subsequent chunks are proportional to $\text{CEILING}(\text{number_of_iterations_remaining} / \text{number_of_threads})$ iterations. If n is greater than 1, each chunk must contain at least n consecutive iterations (except for the last chunk to be assigned, which can have fewer than n iterations). As each thread finishes a chunk, it dynamically obtains the next available chunk.

You can use guided scheduling in a situation in which multiple threads in a team might arrive at a **DO** work-sharing construct at varying times, and each iteration requires roughly the same amount of work. For example, if you have a **DO** loop preceded by one or more work-sharing **SECTIONS** or **DO** constructs with **NOWAIT** clauses, you can guarantee that no thread waits at the barrier longer than it takes another thread to execute its final iteration, or final k iterations if a chunk size of k is specified. The **GUIDED** schedule requires the fewest synchronizations of all the scheduling methods.

An n expression is evaluated outside of the context of the **DO** construct. Any function reference in the n expression must not have side effects.

The value of the n parameter on the **SCHEDULE** clause must be the same for all of the threads in the team.

RUNTIME

Determine the scheduling type at run time.

At run time, the scheduling type can be specified using the environment variable **OMP_SCHEDULE**. If no scheduling type is specified using that variable, the default scheduling type used is **AUTO**.

STATIC

If n has been specified, the iterations of a loop are divided into chunks that contain n iterations. Each thread is assigned chunks in a "round robin" fashion. This is known as block cyclic scheduling. If the value of n is 1, then the scheduling type is specifically referred to as cyclic scheduling.

If n has not been specified, the chunks will contain $\text{FLOOR}(\text{number_of_iterations} / \text{number_of_threads})$ contiguous iterations. The first $\text{REMAINDER}(\text{number_of_iterations}/\text{number_of_threads})$ chunks have one more iteration. Each thread is assigned a separate chunk. This is known as block cyclic scheduling.

If a thread is asleep and it has been assigned work, it will be awakened so that it may complete its work.

The **STATIC** schedule ensures that the same logical iteration numbers are assigned to threads in two work-sharing loop regions if the following conditions are satisfied:

- Both loop regions have the same number of loop iterations
- Both loop regions either have the same value of n specified, or have no n specified
- Both loop regions bind to the same parallel region

A data dependence between the same logical iterations in two such loops is guaranteed to be satisfied to allow the safe use of the **NOWAIT** clause. In addition, you must make sure that all three conditions mentioned above are satisfied to get the correct result.

Consecutive loop constructs with **STATIC** schedule with **NOWAIT** clause now guarantee the same iterations are being assigned to the same thread in the constructs.

For an example of the loop constructs that satisfy all three conditions, see "Example for OpenMP."

Rules

You must not specify the **SCHEDULE** clause more than once for a particular **DO** directive.

Example for OpenMP

The following example illustrates loop constructs that satisfy all three conditions listed in the **STATIC** section.

```
!$OMP PARALLEL
!$OMP DO SCHEDULE(STATIC)
  DO i = 1, n
    c(i) = (a(i) + b(i)) / 2.0;
  ENDDO
!$OMP END DO NOWAIT

!$OMP DO SCHEDULE(STATIC)
  DO i = 1, n
    z(i) = sqrt(c(i))
  ENDDO
!$OMP END DO
!$OMP END PARALLEL
```

Related reference:

“DO / END DO” on page 111

“PARALLEL DO / END PARALLEL DO” on page 123

SHARED

Purpose

All sections use the same copy of the variables and common blocks you specify in *data_scope_entity_list*.

The **SHARED** clause specifies variables that must be available to all threads. If you specify a variable as **SHARED**, you are stating that all threads can safely share a single copy of the variable.

Syntax

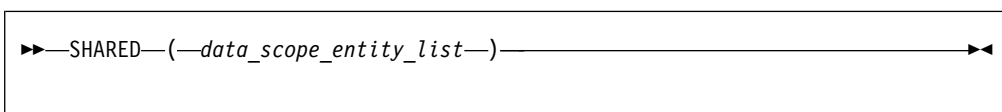

data_scope_entity

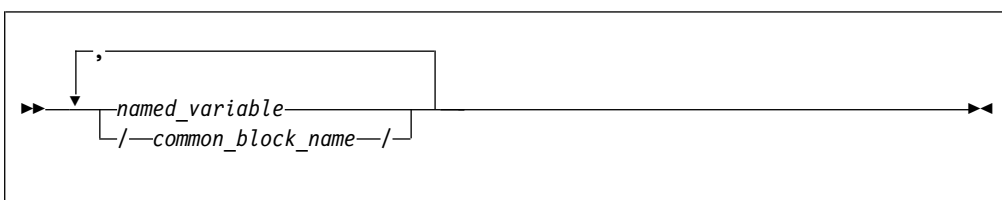

named_variable

is a named variable that is accessible in the directive construct

common_block_name

is a common block name that is accessible in the directive construct

Rules

A variable in the **SHARED** clause must not be either:

- A pointee
- A **THREADLOCAL** common block.
- A **THREADPRIVATE** common block or its members.
- A **THREADPRIVATE** variable.

If a **SHARED** variable, a subobject of a **SHARED** variable, or an object associated with a **SHARED** variable or subobject of a **SHARED** variable appears as an actual argument in a reference to a non-intrinsic procedure and:

- The actual argument is an array section with a vector subscript; or
- The actual argument is
 - An array section,
 - An assumed-shape array, or,

- A pointer array

and the associated dummy argument is an explicit-shape or assumed-size array;

then any references to or definitions of the shared storage that is associated with the dummy argument by any other thread must be synchronized with the procedure reference. In other words, you must structure your code in such a way that if a thread encounters a procedure reference, then the procedure call by that thread and any reference to or definition of the shared storage by any other thread will always occur in the same sequence. You can do this, for example, by placing the procedure reference after a **BARRIER**.

Example for OpenMP

In the following example, the procedure reference with an array section actual argument is required to be synchronized with references to the dummy argument by placing the procedure reference in a critical section, because the associated dummy argument is an explicit-shape array.

```

INTEGER :: abc(10)

i = 2
j = 5

!$OMP PARALLEL DEFAULT(NONE), SHARED(abc, i, j)
!$OMP CRITICAL
! Actual argument is an array section.
! The procedure reference must be in a critical section.
CALL sub1(abc(i: j))
!$OMP END CRITICAL
!$OMP END PARALLEL

CONTAINS
  SUBROUTINE sub1(arr)
    INTEGER:: arr(1: 4)
    DO i = 1, 4
      arr(i) = i
    END DO
  END SUBROUTINE
END

```

Related reference:

PARALLEL / END PARALLEL
 PARALLEL DO / END PARALLEL DO
 PARALLEL SECTIONS / END PARALLEL SECTIONS
 PARALLEL WORKSHARE / END PARALLEL WORKSHARE
 "TASK / END TASK" on page 140

UNTIED

Purpose

The **UNTIED** clause is used with the **TASK** directive. When a task region is suspended, untied tasks can be resumed by any thread in a team.

Syntax

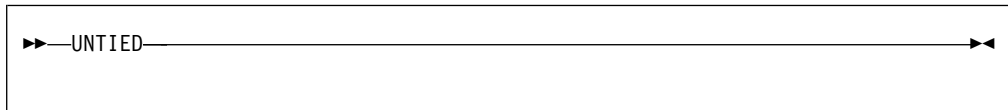

Rules

The **UNTIED** clause is ignored if either of the following conditions is true:

- A **FINAL** clause is specified on the same task construct and the **FINAL** clause expression evaluates to `.TRUE.`.
- The task is an included task.

Related reference:

“TASK / END TASK” on page 140

Routines for OpenMP

The OpenMP specification provides a number of routines that you can use to control and query the parallel execution environment, timing, and lock.

Parallel threads created by the runtime environment through the OpenMP interface are considered independent of the threads you create and control using calls to the **Fortran Pthreads library module**. References within the following descriptions to “serial portions of the program” refer to portions of the program that are executed by only one of the threads that have been created by the runtime environment. For example, you can create multiple threads by using `f_thread_create`. However, if you then call `omp_get_num_threads` from outside of an OpenMP parallel block, or from within a serialized nested parallel region, the function will return `1`, regardless of the number of threads that are currently executing.

OpenMP runtime library calls must not appear in **PURE** and **ELEMENTAL** procedures.

Table 20. OpenMP execution environment routines

• <code>omp_get_active_level</code>	• <code>omp_get_place_proc_ids</code>
• <code>omp_get_ancestor_thread_num</code>	• <code>omp_get_proc_bind</code>
• <code>omp_get_dynamic</code>	• <code>omp_get_schedule</code>
• <code>omp_get_level</code>	• <code>omp_get_thread_num</code>
• <code>omp_get_max_active_levels</code>	• <code>omp_get_team_size</code>
• <code>omp_get_max_threads</code>	• <code>omp_get_thread_limit</code>
• <code>omp_get_nested</code>	• <code>omp_in_final</code>
• <code>omp_get_num_places</code>	• <code>omp_in_parallel</code>
• <code>omp_get_num_procs</code>	• <code>omp_set_dynamic</code>
• <code>omp_get_num_threads</code>	• <code>omp_set_max_active_levels</code>
• <code>omp_get_partition_num_places</code>	• <code>omp_set_nested</code>
• <code>omp_get_partition_place_nums</code>	• <code>omp_set_num_threads</code>
• <code>omp_get_place_num</code>	• <code>omp_set_schedule</code>
• <code>omp_get_place_num_procs</code>	

Included in the OpenMP runtime library are two routines that support a portable wall-clock timer.

Table 21. OpenMP timing routines

• <code>omp_get_wtick</code>	• <code>omp_get_wtime</code>
------------------------------	------------------------------

The OpenMP runtime library also supports a set of simple and nestable lock routines. You must only lock variables through these routines. Simple locks may not be locked if they are already in a locked state. Simple lock variables are associated with simple locks and may only be passed to simple lock routines. Nestable locks may be locked multiple times by the same thread. Nestable lock variables are associated with nestable locks and may only be passed to nestable lock routines. Note that locks are now associated with task regions, and no longer with threads as such, in accordance with changes in the OMP standard.

For all the routines listed below, the lock variable is an integer whose **KIND** type parameter is denoted either by the symbolic constant `omp_lock_kind`, or by `omp_nest_lock_kind`.

This variable is sized to 8.

Table 22. OpenMP simple lock routines

• <code>omp_destroy_lock</code>	• <code>omp_test_lock</code>
• <code>omp_init_lock</code>	• <code>omp_unset_lock</code>
• <code>omp_set_lock</code>	

Table 23. OpenMP nestable lock routines

• <code>omp_destroy_nest_lock</code>	• <code>omp_test_nest_lock</code>
• <code>omp_init_nest_lock</code>	• <code>omp_unset_nest_lock</code>
• <code>omp_set_nest_lock</code>	

Note: You can define and implement your own versions of the OpenMP routines. However, by default, the compiler will substitute the XL Fortran versions of the OpenMP routines regardless of the existence of other implementations, unless you specify the `-qnoswapomp` compiler option. For more information, see *XL Fortran Compiler Reference*.

`omp_destroy_lock(svar)`

Purpose

The `omp_destroy_lock` subroutine disassociates a given lock variable from all locks. You must use `omp_init_lock` to reinitialize a lock variable that was destroyed with a call to `omp_destroy_lock` before using it again as a lock variable.

If you call `omp_destroy_lock` with an uninitialized lock variable, the result of the call is undefined.

Class

Subroutine.

Argument Type and Attributes

`svar` Type integer with kind `omp_lock_kind`.

Result Type and Attributes

None.

Result Value

None.

Examples

In the following example, threads and their associated tasks are generated by the parallel region, and one at a time, each task gains ownership of the lock associated with the lock variable LCK, prints the thread ID, and releases ownership of the lock.

```
      USE omp_lib
      INTEGER(kind=omp_lock_kind) LCK
      INTEGER ID
      CALL omp_init_lock(LCK)
!$OMP PARALLEL SHARED(LCK), PRIVATE(ID)
      ID = omp_get_thread_num()
      CALL omp_set_lock(LCK)
      PRINT *, 'MY THREAD ID IS', ID
      CALL omp_unset_lock(LCK)
!$OMP END PARALLEL
      CALL omp_destroy_lock(LCK)
      END
```

omp_destroy_nest_lock(nvar)

Purpose

The **omp_destroy_nest_lock** subroutine initializes a nestable lock variable, causing the lock variable to become undefined. The variable *nvar* must be an unlocked and initialized nestable lock variable.

If you call **omp_destroy_nest_lock** using an uninitialized variable, the result is undefined.

Class

Subroutine.

Argument Type and Attributes

nvar Type integer with kind **omp_nest_lock_kind**.

Result Type and Attributes

None.

Result Value

None.

omp_get_active_level()

Purpose

The `omp_get_active_level` function returns the number of nested, active parallel regions.

Class

Function.

Argument Type and Attributes

None.

Result Type and Attributes

Default integer.

Result Value

An integer that indicates the number of nested, active parallel regions.

omp_get_ancestor_thread_num(level)

Purpose

The `omp_get_ancestor_thread_num` function returns the thread number of the ancestor at a given nested level of the current thread.

Class

Function.

Argument Type and Attributes

level

Default integer.

Result Type and Attributes

Default integer.

Result Value

The thread number of the ancestor at a given nested level (*level*) of the current thread. If *level* is outside the range of 0 and the nested level of the current thread, as returned by the `omp_get_level` routine, the function returns -1.

omp_get_dynamic()

Purpose

The `omp_get_dynamic` function returns `.TRUE.` if dynamic thread adjustment by the runtime environment is enabled. Otherwise, the `omp_get_dynamic` function returns `.FALSE.`

Class

Function.

Argument Type and Attributes

None.

Result Type and Attributes

Default logical.

Result Value

.TRUE. if dynamic thread adjustment by the runtime environment is enabled;
.FALSE. otherwise.

omp_get_level()

Purpose

The `omp_get_level` function returns the number of nested parallel regions (both active and inactive).

Class

Function.

Argument Type and Attributes

None.

Result Type and Attributes

Default integer.

Result Value

The number of nested parallel regions (both active and inactive) in which the generating task is executing, not including the implicit parallel region. Returns 0 if it is called from the sequential part of the program. Otherwise, returns a nonnegative integer.

omp_get_max_active_levels()

Purpose

The `omp_get_max_active_levels` function returns the maximum number of nested, active parallel regions.

Class

Function.

Argument Type and Attributes

None.

Result Type and Attributes

Default integer.

Result Value

The maximum number of nested, active parallel regions that is allowed.

omp_get_max_threads()

Purpose

The **omp_get_max_threads** routine returns the first value of *num_list* for the **OMP_NUM_THREADS** environment variable. This value is the maximum number of threads that can be used to form a new team if a parallel region without a **num_threads** clause is encountered.

If you use **omp_set_num_threads** to change the number of threads, subsequent calls to **omp_get_max_threads** will return the new value.

The routine has global scope, which means that the maximum value it returns applies to all routines, subroutines, and compilation units in the program. It returns the same value whether executing from a serial or parallel region.

You can use **omp_get_max_threads** to allocate maximum-sized data structures for each thread when you have enabled dynamic thread adjustment by passing **omp_set_dynamic** an argument which evaluates to **.TRUE**.

Class

Function.

Argument Type and Attributes

None.

Result Type and Attributes

Default integer.

Result Value

The maximum number of threads that can execute concurrently in a single parallel region.

omp_get_nested()

Purpose

The **omp_get_nested** function returns **.TRUE**, if nested parallelism is enabled and **.FALSE**, if nested parallelism is disabled.

Class

Function

Argument Type and Attributes

None.

Result Type and Attributes

Default logical.

Result Value

.TRUE. if nested parallelism is enabled. .FALSE. otherwise.

omp_get_num_places()

Purpose

The `omp_get_num_places` function returns the number of places that are available to the execution environment in the place list.

Class

Function.

Argument Type and Attributes

None.

Result Type and Attributes

Default integer.

Result Value

The number of places in the *place-partition-var* internal control variable (ICV) in the execution environment of the initial task.

omp_get_num_procs()

Purpose

The `omp_get_num_procs` function returns the number of online processors on the machine.

Class

Function.

Argument Type and Attributes

None.

Result Type and Attributes

Default integer.

Result Value

The number of online processors on the machine.

omp_get_num_threads()

Purpose

The **omp_get_num_threads** function returns the number of threads in the team currently executing the parallel region from which it is called. The function binds to the closest enclosing **PARALLEL** directive.

The **omp_set_num_threads** subroutine and the **OMP_NUM_THREADS** environment variable control the number of threads in a team. If you do not explicitly set the number of threads, the runtime environment will use the number of online processors on the machine by default. The number of online processors is less than or equal to the number of physical processors actually installed in a machine.

If you call **omp_get_num_threads** from a serial portion of your program or from a nested parallel region that is serialized, the function returns 1.

Class

Function.

Argument Type and Attributes

None.

Result Type and Attributes

Default integer.

Result Value

The number of threads in the team currently executing the parallel region from which the function is called.

Examples

```
USE omp_lib
INTEGER N1, N2

N1 = omp_get_num_threads()
PRINT *, N1
!$OMP PARALLEL PRIVATE(N2)
N2 = omp_get_num_threads()
PRINT *, N2
!$OMP END PARALLEL
END
```

The **omp_get_num_threads** call returns 1 in the serial section of the code, so N1 is assigned the value 1. N2 is assigned the number of threads in the team executing the parallel region, so the output of the second print statement will be an arbitrary number less than or equal to the value returned by **omp_get_max_threads**.

omp_get_partition_num_places()

Purpose

The `omp_get_partition_num_places` function returns the number of places in the place partition of the innermost implicit task.

Class

Function.

Argument Type and Attributes

None.

Result Type and Attributes

Default integer.

Result Value

The number of places in the *place-partition-var* internal control variable (ICV).

omp_get_partition_place_nums(place_nums)

Purpose

The `omp_get_partition_place_nums` subroutine returns the list of place numbers corresponding to the places in the *place-partition-var* internal control variable (ICV) of the innermost implicit task. The *place-partition-var* ICV controls the place partition that is available to the execution environment for encountered parallel regions. Each implicit task has one copy of the *place-partition-var* ICV.

Class

Subroutine.

Argument Type and Attributes

place_nums

An assumed-size array of integer type.

Result Type and Attributes

None.

Result Value

None.

Usage

The size of the array *place_nums* that contains place numbers must be equal to or larger than the return value of `omp_get_partition_num_places()`; otherwise, the behavior is undefined.

omp_get_place_num()

Purpose

The `omp_get_place_num` function returns the place number of the place to which the encountering thread is bound.

Class

Function.

Argument Type and Attributes

None.

Result Type and Attributes

Default integer.

Result Value

The place number of the place to which the encountering thread is bound.

Usage

When the encountering thread is bound to a place, the routine returns the place number that is associated with the thread. The returned value is between -1 and the return value of `omp_get_num_places()` exclusive. When the encountering thread is not bound to a place, the routine returns -1.

omp_get_place_num_procs(place_num)

Purpose

The `omp_get_place_num_procs` function returns the number of processors that are available to the execution environment in the specified place.

Class

Function.

Argument Type and Attributes

place_num

Default integer.

Result Type and Attributes

Default integer.

Result Value

The routine returns the number of processors that are associated with the place that is numbered *place_num*. The routine returns zero when *place_num* is negative or is equal to or larger than the result value of `omp_get_num_places()`.

omp_get_place_proc_ids(place_num, ids)

Purpose

The `omp_get_place_proc_ids` subroutine returns the numerical identifiers of the processors that are available to the execution environment in the specified place.

Class

Subroutine.

Argument Type and Attributes

place_num

Default integer.

ids

An assumed-size array of integer type.

Result Type and Attributes

None.

Result Value

None.

Usage

The routine returns the non-negative numerical identifiers of each processor that is associated with the place that is numbered *place_num*. The numerical identifiers are returned in the array *ids* whose size must be equal to or larger than the return value of `omp_get_place_num_procs(place_num)`; otherwise, the behavior is undefined. The routine has no effect when *place_num* is a negative value or is equal to or larger than the return value of `omp_get_num_places()`.

omp_get_proc_bind()

Purpose

Returns the thread affinity policy to be applied for the subsequent nested parallel regions that do not specify a `proc_bind` clause.

Class

Function.

Argument Type and Attributes

None.

Result Type and Attributes

Default integer of kind `omp_proc_bind_kind` as defined in the `omp_lib` module.

Result Value

The result value is one of the following constant parameters that are defined in the `omp_lib` module:

- `omp_proc_bind_false`
- `omp_proc_bind_true`
- `omp_proc_bind_master`
- `omp_proc_bind_close`
- `omp_proc_bind_spread`

Related information:

“OMP_PROC_BIND” on page 92

`omp_get_schedule(kind, modifier)`

Purpose

The `omp_get_schedule` subroutine returns the scheduling type that is applied when using the **runtime** schedule. The argument *kind* returns the type of schedule that is used. *modifier* represents the chunk size that is set for applicable schedule types.

Class

Subroutine.

Argument Type and Attributes

kind

Integer of kind `omp_sched_kind`. The value returned for *kind* is one of the following constants that are defined in `omp_lib` module:

- `omp_sched_static`
- `omp_sched_dynamic`
- `omp_sched_guided`
- `omp_sched_auto`
- `ibm_sched_affinity`

where `ibm_sched_affinity` is not part of the OpenMP specification.

Note: `ibm_sched_affinity` has been deprecated and might be removed in a future release. You can use `omp_sched_guided` for a similar functionality.

modifier

Default integer. For the schedule type **dynamic**, **guided**, or **static**, *modifier* is the chunk size that is set. For the schedule type **auto**, *modifier* has no meaning.

Result Type and Attributes

None.

Result Value

None.

omp_get_team_size(level)

Purpose

The `omp_get_team_size` function returns the size of the thread team that the ancestor belongs to.

Class

Function.

Argument Type and Attributes

level

Default integer. *level* is the nested level of the current thread.

Result Type and Attributes

Default integer.

Result Value

The size of the thread team that the ancestor belongs to. If *level* is outside of the range of 0 and the nested level of the current thread, as returned by the `omp_get_level` function, the function returns -1.

omp_get_thread_limit()

Purpose

The `omp_get_thread_limit` function returns the maximum number of OpenMP threads that are available to the program.

Class

Function.

Argument Type and Attributes

None.

Result Type and Attributes

Default integer.

Result Value

The maximum number of OpenMP threads that are available to the program.

omp_get_thread_num()

Purpose

The `omp_get_thread_num` function returns the number of the currently executing thread within the team. The number returned will always be between 0 and `NUM_PARTHDS - 1`. `NUM_PARTHDS` is the number of currently executing threads within the team. The master thread of the team returns a value of 0.

If you call `omp_get_thread_num` from within a serial region, from within a serialized nested parallel region, or from outside the dynamic extent of any parallel region, this function will return a value of 0.

This function binds to the closest parallel region.

Class

Function.

Argument Type and Attributes

None.

Result Type and Attributes

Default integer.

Result Value

The value of the currently executing thread within the team between 0 and `NUM_PARTHDS - 1`. `NUM_PARTHDS` is the number of currently executing threads within the team. A call to `omp_get_thread_num` from a serialized nested parallel region, or from outside the dynamic extent of any parallel region returns 0.

Examples

The following example illustrates the return value of the `omp_get_thread_num` routine in a PARALLEL region and a MASTER construct.

```
USE omp_lib
INTEGER NP
call omp_set_num_threads(4) ! 4 threads are used in the
                           ! parallel region

!$OMP PARALLEL PRIVATE(NP)
  NP = omp_get_thread_num()
  CALL WORK('in parallel', NP)
!$OMP END PARALLEL

!$OMP MASTER
  NP = omp_get_thread_num()
  CALL WORK('in master', NP)
!$OMP END MASTER
!$OMP END PARALLEL
END
SUBROUTINE WORK(msg, THD_NUM)
  INTEGER THD_NUM
  character(*) msg
  PRINT *, msg, THD_NUM
END
```

Output:

```
in parallel 1
in parallel 3
in parallel 2
in parallel 0
in master 0
```

(The order may be different.)

omp_get_wtick()

Purpose

The **omp_get_wtick** function returns a double precision value equal to the number of seconds between consecutive clock ticks.

Class

Function.

Argument Type and Attributes

None.

Result Type and Attributes

Double precision real.

Result Value

The number of seconds between consecutive ticks of the operating system real-time clock.

Examples

```
USE omp_lib
DOUBLE PRECISION WTICKS
WTICKS = omp_get_wtick()
PRINT *, 'The clock ticks ', 10 / WTICKS, &
' times in 10 seconds.'
END
```

omp_get_wtime()

Purpose

The **omp_get_wtime** function returns a double precision value equal to the number of seconds since the initial value of the operating system real-time clock. The initial value is guaranteed not to change during execution of the program.

The value returned by the **omp_get_wtime** function is not consistent across all threads in the team.

Class

Function.

Argument Type and Attributes

None.

Result Type and Attributes

Double precision real.

Result Value

The number of seconds since the initial value of the operating system real-time clock.

Examples

```
USE omp_lib
DOUBLE PRECISION START, END
START = omp_get_wtime()
! Work to be timed
END = omp_get_wtime()
PRINT *, 'Stuff took ', END - START, ' seconds.'
END
```

omp_in_final()

Purpose

The **omp_in_final** routine returns **.TRUE.** if the routine is called in a final task region. Otherwise, the routine returns **.FALSE.**

Class

Function.

Argument Type and Attributes

None.

Result Type and Attributes

Default logical.

Result Value

If the routine is called in a final task region, the result value is **.TRUE.**; otherwise, the result value is **.FALSE.**

omp_in_parallel()

Purpose

The **omp_in_parallel** function returns **.TRUE.** if you call it from the dynamic extent of a region executing in parallel and returns **.FALSE.** otherwise. If you call **omp_in_parallel** from a region that is serialized but nested within the dynamic extent of a region executing in parallel, the function will still return **.TRUE.** (Nested parallel regions are serialized by default. See “omp_set_nested(enable_expr)” on page 200 and the **OMP_NESTED** environment variable for more information.)

Class

Function.

Argument Type and Attributes

None.

Result Type and Attributes

Default logical.

Result Value

.TRUE. if called from the dynamic extent of a region executing in parallel. **.FALSE.** otherwise.

Examples

In the following example, the first call to **omp_in_parallel** returns **.FALSE.** because the call is outside the dynamic extent of any parallel region. The second call returns **.TRUE.**, even if the nested **PARALLEL DO** loop is serialized, because the call is still inside the dynamic extent of the outer **PARALLEL DO** loop.

```
USE omp_lib
INTEGER N, M
N = 4
M = 3
PRINT*, omp_in_parallel()
!$OMP PARALLEL DO
DO I = 1,N
!$OMP PARALLEL DO
DO J=1, M
PRINT *, omp_in_parallel()
END DO
!$OMP END PARALLEL DO
END DO
!$OMP END PARALLEL DO
END
```

omp_init_lock(svar)

Purpose

The **omp_init_lock** subroutine initializes a lock and associates it with the lock variable passed in as a parameter. After the call to **omp_init_lock**, the initial state of the lock variable is unlocked.

If you call this routine with a lock variable that you have already initialized, the result of the call is undefined.

Class

Subroutine.

Argument Type and Attributes

svar Integer of kind **omp_lock_kind**.

Result Type and Attributes

None.

Result Value

None.

Examples

In the following example, threads and their associated tasks are generated by the parallel region, and one at a time, each task gains ownership of the lock associated with the lock variable LCK, prints the thread ID, and releases ownership of the lock.

```
USE omp_lib
INTEGER(kind=omp_lock_kind) LCK
INTEGER ID
CALL omp_init_lock(LCK)
!$OMP PARALLEL SHARED(LCK), PRIVATE(ID)
  ID = omp_get_thread_num()
  CALL omp_set_lock(LCK)
  PRINT *, 'MY THREAD ID IS', ID
  CALL omp_unset_lock(LCK)
!$OMP END PARALLEL
CALL omp_destroy_lock(LCK)
END
```

omp_init_nest_lock(nvar)

Purpose

The **omp_init_nest_lock** subroutine allows you to initialize a nestable lock and associate it with the lock variable you specify. The initial state of the lock variable is unlocked, and the initial nesting count is zero. The *nvar* must be an uninitialized nestable lock variable.

If you call **omp_init_nest_lock** using a variable that is already initialized, the result is undefined.

Class

Subroutine.

Argument Type and Attributes

nvar Integer of kind **omp_nest_lock_kind**.

Result Type and Attributes

None.

Result Value

None.

Examples

The following example illustrates the use of a nestable lock for updating variable P in the PARALLEL SECTIONS construct.

```
USE omp_lib
INTEGER P
INTEGER A
INTEGER B
INTEGER ( kind=omp_nest_lock_kind ) LCK
CALL omp_init_nest_lock ( LCK ) ! initialize the nestable lock
!$OMP PARALLEL SECTIONS
!$OMP SECTION
  CALL omp_set_nest_lock ( LCK )
```

```

      P = P + A
      CALL omp_set_nest_lock ( LCK )
      P = P + B
      CALL omp_unset_nest_lock ( LCK )
      CALL omp_unset_nest_lock ( LCK )
!$OMP SECTION
      CALL omp_set_nest_lock ( LCK )
      P = P + B
      CALL omp_unset_nest_lock ( LCK )
!$OMP END PARALLEL SECTIONS

      CALL omp_destroy_nest_lock ( LCK )
      END

```

omp_set_dynamic(enable_expr)

Purpose

The **omp_set_dynamic** subroutine enables or disables dynamic adjustment, by the runtime environment, of the number of threads available to execute parallel regions.

If **enable_expr** is evaluated to **.TRUE.**, the runtime environment can automatically adjust the number of threads that are used to execute subsequent parallel regions to obtain the best use of system resources. The number of threads you specify using **omp_set_num_threads** becomes the maximum, not exact, thread count.

If **enable_expr** is evaluated to **.FALSE.**, dynamic adjustment of the number of threads is disabled. The runtime environment cannot automatically adjust the number of threads used to execute subsequent parallel regions. The value you pass to **omp_set_num_threads** becomes the exact thread count.

By default, dynamic thread adjustment is disabled. If your code depends on a specific number of threads for correct execution, you should explicitly disable dynamic threads.

If the routine is called from a portion of the program where the **omp_in_parallel** routine returns **.TRUE.**, the routine has no effect.

This subroutine has precedence over the **OMP_DYNAMIC** environment variable.

Class

Subroutine.

Argument Type and Attributes

enable_expr
Logical.

Result Type and Attributes

None.

Result Value

None.

omp_set_lock(svar)

Purpose

The **omp_set_lock** subroutine forces the calling task region to wait until the specified lock is available before executing subsequent instructions. The calling task region is given ownership of the lock when it becomes available.

If you call this routine with an uninitialized lock variable, the result of the call is undefined. If a task region that owns a lock tries to lock it again by issuing a call to **omp_set_lock**, the call produces a deadlock.

Class

Subroutine.

Argument Type and Attributes

svar Integer of kind **omp_lock_kind**.

Result Type and Attributes

None.

Result Value

None.

Examples

In the following example, the lock variable **LCK_X** is used to avoid race conditions when updating the shared variable **X**. By setting the lock before each update to **X** and unsetting it after the update, you ensure that only one task region updates **X** at a given time.

```
USE omp_lib
INTEGER A(100), X
INTEGER(kind=omp_lock_kind) LCK_X
X=1
CALL omp_init_lock (LCK_X)
!$OMP PARALLEL PRIVATE (I), SHARED (A, X)
!$OMP DO
DO I = 3, 100
  A(I) = I * 10
  CALL omp_set_lock (LCK_X)
  X = X + A(I)
  CALL omp_unset_lock (LCK_X)
END DO
!$OMP END DO
!$OMP END PARALLEL
CALL omp_destroy_lock (LCK_X)
END
```

omp_set_max_active_levels(max_levels)

Purpose

The **omp_set_max_active_levels** subroutine limits the number of nested, active parallel regions. Use **omp_set_max_active_levels** only in serial regions of a program. This routine has no effect in parallel regions of a program.

Class

Subroutine.

Argument Type and Attributes

max_levels
Default integer.

Result Type and Attributes

None.

Result Value

None.

omp_set_nested(enable_expr)

Purpose

The **omp_set_nested** subroutine enables or disables nested parallelism.

If **enable_expr** is evaluated to **.FALSE.**, nested parallelism is disabled. Nested parallel regions are serialized, and they are executed by the current thread. This is the default setting.

If **enable_expr** is evaluated to **.TRUE.**, nested parallelism is enabled. Parallel regions that are nested can deploy additional threads to the team. It is up to the runtime environment to determine whether additional threads should be deployed. Therefore, the number of threads used to execute parallel regions may vary from one nested region to the next.

If the routine is called from a portion of the program where the **omp_in_parallel** routine returns true, the routine has no effect.

The setting of the **omp_set_nested** subroutine overrides the setting of the **OMP_NESTED** environment variable.

Note: If the number of threads from all regions exceeds the number of available processors, your program might suffer performance degradation.

Class

Subroutine.

Argument Type and Attributes

enable_expr
Logical.

Result Type and Attributes

Default logical.

Result Value

None.

omp_set_nest_lock(nvar)

Purpose

The **omp_set_nest_lock** subroutine allows you to set a nestable lock. The task region executing the subroutine will wait until the lock becomes available and then set that lock, incrementing the nesting count. A nestable lock is available if it is owned by the task region executing the subroutine, or is unlocked.

Class

Subroutine.

Argument Type and Attributes

nvar Integer of kind **omp_nest_lock_kind**.

Result Type and Attributes

None.

Result Value

None.

Examples

```
USE omp_lib
INTEGER P
INTEGER A
INTEGER B
INTEGER ( kind=omp_nest_lock_kind ) LCK

CALL omp_init_nest_lock ( LCK )

!$OMP PARALLEL SECTIONS
!$OMP SECTION
CALL omp_set_nest_lock ( LCK )
P = P + A
CALL omp_set_nest_lock ( LCK )
P = P + B
CALL omp_unset_nest_lock ( LCK )
CALL omp_unset_nest_lock ( LCK )
!$OMP SECTION
CALL omp_set_nest_lock ( LCK )
P = P + B
CALL omp_unset_nest_lock ( LCK )
!$OMP END PARALLEL SECTIONS

CALL omp_destroy_nest_lock ( LCK )
END
```

omp_set_num_threads(number_of_threads_expr)

Purpose

The **omp_set_num_threads** routine specifies the number of threads to use for the next parallel region by setting the first value of *num_list* for the **OMP_NUM_THREADS** environment variable.

The **number_of_threads_expr** argument is evaluated, and its value is used as the number of threads. If you have enabled dynamic adjustment of the number of threads (see “**omp_set_dynamic(enable_expr)**” on page 198), **omp_set_num_threads** sets the maximum number of threads to use for the next parallel region. The runtime environment then determines the exact number of threads to use. However, when dynamic adjustment of the number of threads is disabled, **omp_set_num_threads** sets the exact number of threads to use in the next parallel region. If the number of threads you request exceeds the number your execution environment can support, your application will terminate.

This subroutine takes precedence over the **OMP_NUM_THREADS** environment variable.

If you call this subroutine from the dynamic extent of a region executing in parallel, the behavior of the subroutine is undefined.

Class

Subroutine.

Argument Type and Attributes

number_of_threads_expr
integer

Result Type and Attributes

None.

Result Value

None.

omp_set_schedule(kind, modifier)

Purpose

The **omp_set_schedule** routine affects the schedule that is applied when **runtime** is used as schedule kind. Use **omp_set_schedule** if you want to set the schedule type separately from the **OMP_SCHEDULE** environment variable.

Note: You can use the **omp_get_schedule** to return scheduling type. For details, see **omp_get_schedule** .

Class

Subroutine.

Argument Type and Attributes

kind

Type integer with kind `omp_sched_kind`. Must be one of the schedule types as represented by the following constants:

- `omp_sched_static`
- `omp_sched_dynamic`
- `omp_sched_guided`
- `omp_sched_auto`
- `ibm_sched_affinity`

where `ibm_sched_affinity` is not part of the OpenMP.

Note: `ibm_sched_affinity` has been deprecated and might be removed in a future release. You can use `omp_sched_guided` for a similar functionality.

modifier

Default integer. For the schedule type `dynamic`, `guided`, or `static`, *modifier* is the chunk size that you want to set. Typically, it is a positive integer. If the value is less than one, the default is used. For the schedule type `auto`, *modifier* has no meaning. For the default setting of each schedule type, see `-qsm` in the *XL Fortran Compiler Reference*.

Result Type and Attributes

None.

Result Value

None.

`omp_test_lock(svar)`

Purpose

The `omp_test_lock` function attempts to set the lock associated with the specified lock variable. It returns `.TRUE.` if it was able to set the lock and `.FALSE.` otherwise. In either case, the calling task region will continue to execute subsequent instructions in the program.

If you call `omp_test_lock` with an uninitialized lock variable, the result of the call is undefined.

Class

Function.

Argument Type and Attributes

`svar` Integer of kind `omp_lock_kind`.

Result Type and Attributes

Default logical.

Result Value

.TRUE. if the function was able to set the lock. **.FALSE.** otherwise.

Examples

In the following example, a task region repeatedly executes `WORK_A` until it can set the lock variable, `LCK`. When the lock is set, the task region executes `WORK_B`.

```
USE omp_lib
INTEGER LCK
INTEGER ID
CALL omp_init_lock (LCK)
!$OMP PARALLEL SHARED(LCK), PRIVATE(ID)
  ID = omp_get_thread_num()
  DO WHILE (.NOT. omp_test_lock(LCK))
    CALL WORK_A (ID)
  END DO
  CALL WORK_B (ID)
  CALL omp_unset_lock (LCK)
!$OMP END PARALLEL
CALL omp_destroy_lock (LCK)
END
```

`omp_test_nest_lock(nvar)`

Purpose

The `omp_test_nest_lock` subroutine allows you to attempt to set a lock using the same method as `omp_set_nest_lock`, but the executing task region does not wait for confirmation that the lock is available. If the lock is successfully set, the function will increment the nesting count and return the new nesting count. If the lock is unavailable the function returns a value of zero. Also, a child task sees a value of zero if the parent task has already set the same lock. The result value is always a default integer.

Class

Function.

Argument Type and Attributes

`nvar` Integer of kind `omp_nest_lock_kind`.

Result Type and Attributes

Default integer.

Result Value

The new nesting count if the lock is successfully set; otherwise, it returns zero.

`omp_unset_lock(svar)`

Purpose

The `omp_unset_lock` subroutine causes the executing task region to release ownership of the specified lock. The lock can then be set by another task region as required. The behavior of the `omp_unset_lock` subroutine is undefined if either of the following conditions occur:

- The calling task region does not own the lock specified.
- The routine is called with an uninitialized lock variable.

Class

Subroutine.

Argument Type and Attributes

svar Integer of kind `omp_lock_kind`.

Result Type and Attributes

None.

Result Value

None.

Examples

```

USE omp_lib
INTEGER A(100)
INTEGER(kind=omp_lock_kind) LCK_X
CALL omp_init_lock (LCK_X)
!$OMP PARALLEL PRIVATE (I), SHARED (A, X)
!$OMP DO
DO I = 3, 100
  A(I) = I * 10
  CALL omp_set_lock (LCK_X)
  X = X + A(I)
  CALL omp_unset_lock (LCK_X)
END DO
!$OMP END DO
!$OMP END PARALLEL
CALL omp_destroy_lock (LCK_X)
END

```

In this example, the lock variable `LCK_X` is used to avoid race conditions when updating the shared variable `X`. By setting the lock before each update to `X` and unsetting it after the update, you ensure that only one task region is updating `X` at a given time.

`omp_unset_nest_lock(nvar)`

Purpose

The `omp_unset_nest_lock` subroutine allows you to release ownership of a nestable lock. The subroutine decrements the nesting count and releases the associated task region from ownership of the nestable lock.

Class

Subroutine.

Argument Type and Attributes

nvar Integer of kind `omp_lock_kind`.

Result Type and Attributes

None.

Result Value

None.

Examples

```
USE omp_lib
INTEGER P
INTEGER A
INTEGER B
INTEGER ( kind=omp_nest_lock_kind ) LCK

CALL omp_init_nest_lock ( LCK )

!$OMP PARALLEL SECTIONS
!$OMP SECTION
CALL omp_set_nest_lock ( LCK )
P = P + A
CALL omp_set_nest_lock ( LCK )
P = P + B
CALL omp_unset_nest_lock ( LCK )
CALL omp_unset_nest_lock ( LCK )
!$OMP SECTION
CALL omp_set_nest_lock ( LCK )
P = P + B
CALL omp_unset_nest_lock ( LCK )
!$OMP END PARALLEL SECTIONS

CALL omp_destroy_nest_lock ( LCK )
END
```

Pthreads Library Module

The Pthreads Library Module (**f_pthread**) is a Fortran 90 module that defines data types and routines to make it easier to interface with the Linux pthreads library. The Linux pthreads library is used to parallelize and to make your code thread-safe.

The **f_pthread** library module naming convention is the use of the prefix **f_** before the corresponding Linux pthreads library routine name or type definition name.

In general, there is a one-to-one corresponding relationship between the procedures in the Fortran 90 module **f_pthread** and the library routines contained in the Linux pthreads library. However, some of the pthread routines have no corresponding procedures in this module because they are not supported on Linux. One example of these routines is the thread stack address option. There are also some non-pthread interfacing routines contained in the **f_pthread** library module. The **f_maketime** routine is one example and is included to return an absolute time in a **f_timespec** derived type variable.

Most of the routines return an integer value. A return value of **0** will always indicate that the routine call did not result in any error. Any non-zero return value indicates an error. Each error code has a corresponding definition of a system error code in Fortran. These error codes are available as Fortran integer constants. The naming of these error codes in Fortran is consistent with the corresponding Linux

error code names. For example, `EINVAL` is the Fortran constant name of the error code `EINVAL` on the system. For a complete list of these error codes, refer to the file `/usr/include/errno.h`.

Note: The `pthread` module in XL Fortran is an extension to the standard Fortran language.

Pthreads data structures, functions, and subroutines

Pthreads data types

- `f_pthread_attr_t`
- `f_pthread_cond_t`
- `f_pthread_condattr_t`
- `f_pthread_key_t`
- `f_pthread_mutex_t`
- `f_pthread_mutexattr_t`
- `f_pthread_once_t`
- `f_pthread_rwlock_t`
- `f_pthread_rwlockattr_t`
- `f_pthread_t`
- `f_sched_param`
- `f_timespec`

Functions that perform operations on thread attribute objects

- `f_pthread_attr_destroy(attr)`
- `f_pthread_attr_getdetachstate(attr, detach)`
- `f_pthread_attr_getguardsize(attr, guardsize)`
- `f_pthread_attr_getinheritsched(attr, inherit)`
- `f_pthread_attr_getschedparam(attr, param)`
- `f_pthread_attr_getschedpolicy(attr, policy)`
- `f_pthread_attr_getscope(attr, scope)`
- `f_pthread_attr_getstack(attr, stackaddr, ssize)`
- `f_pthread_attr_init(attr)`
- `f_pthread_attr_setdetachstate(attr, detach)`
- `f_pthread_attr_setguardsize(attr, guardsize)`
- `f_pthread_attr_setinheritsched(attr, inherit)`
- `f_pthread_attr_setschedparam(attr, param)`
- `f_pthread_attr_setschedpolicy(attr, policy)`
- `f_pthread_attr_setscope(attr, scope)`
- `f_pthread_attr_setstack(attr, stackaddr, ssize)`

Functions and subroutines that perform operations on threads

- `f_pthread_cancel(thread)`
- `f_pthread_cleanup_pop(exec)`
- `f_pthread_cleanup_push(cleanup, flag, arg)`
- `f_pthread_create(thread, attr, flag, ent, arg)`
- `f_pthread_detach(thread)`
- `f_pthread_equal(thread1, thread2)`

- `f_thread_exit(ret)`
- `f_thread_getconcurrency()`
- `f_thread_getschedparam(thread, policy, param)`
- `f_thread_join(thread, ret)`
- `f_thread_kill(thread, sig)`
- `f_thread_self()`
- `f_thread_setconcurrency(new_level)`
- `f_thread_setschedparam(thread, policy, param)`

Functions that perform operations on mutex attribute objects

- `f_thread_mutexattr_destroy(mattr)`
- `f_thread_mutexattr_getpshared(mattr, pshared)`
- `f_thread_mutexattr_gettype(mattr, type)`
- `f_thread_mutexattr_init(mattr)`
- `f_thread_mutexattr_setpshared(mattr, pshared)`
- `f_thread_mutexattr_settype(mattr, type)`

Functions that perform operations on mutex objects

- `f_thread_mutex_destroy(mutex)`
- `f_thread_mutex_init(mutex, mattr)`
- `f_thread_mutex_lock(mutex)`
- `f_thread_mutex_trylock(mutex)`
- `f_thread_mutex_unlock(mutex)`

Functions that perform operations on attribute objects of condition variables

- `f_thread_condattr_destroy(cattr)`
- `f_thread_condattr_getpshared(cattr, pshared)`
- `f_thread_condattr_init(cattr)`
- `f_thread_condattr_setpshared(cattr, pshared)`

Functions that perform operations on condition variable objects

- `f_maketime(delay)`
- `f_thread_cond_broadcast(cond)`
- `f_thread_cond_destroy(cond)`
- `f_thread_cond_init(cond, cattr)`
- `f_thread_cond_signal(cond)`
- `f_thread_cond_timedwait(cond, mutex, timeout)`
- `f_thread_cond_wait(cond, mutex)`

Functions that perform operations on thread-specific data

- `f_thread_getspecific(key, arg)`
- `f_thread_key_create(key, dtr)`
- `f_thread_key_delete(key)`
- `f_thread_setspecific(key, arg)`

Functions and subroutines that perform operations to control thread cancelability

- `f_thread_setcancelstate(state, oldstate)`
- `f_thread_setcanceltype(type, oldtype)`
- `f_thread_testcancel()`

Functions that perform operations on read-write lock attribute objects

- `f_thread_rwlockattr_destroy(rwattr)`
- `f_thread_rwlockattr_getpshared(rwattr, pshared)`
- `f_thread_rwlockattr_init(rwattr)`
- `f_thread_rwlockattr_setpshared(rwattr, pshared)`

Functions that perform operations on read-write lock objects

- `f_thread_rwlock_destroy(rwlock)`
- `f_thread_rwlock_init(rwlock, rwattr)`
- `f_thread_rwlock_rdlock(rwlock)`
- `f_thread_rwlock_tryrdlock(rwlock)`
- `f_thread_rwlock_trywrlock(rwlock)`
- `f_thread_rwlock_unlock(rwlock)`
- `f_thread_rwlock_wrlock(rwlock)`

Functions that perform operations for one-time initialization

- `f_thread_once(once, initr)`

f_gettime(delay)

Purpose

This function accepts an integer value specifying a delay in seconds and returns an `f_timespec` type object containing the absolute time, which is **delay** seconds from the calling moment.

Class

Function

Argument Type and Attributes

`delay` INTEGER(4), INTENT(IN)

Result Type and Attributes

TYPE (`f_timespec`)

Result Value

The absolute time, which is **delay** seconds from the calling moment, is returned.

f_thread_attr_destroy(attr)

Purpose

This function must be called to destroy any previously initialized thread attribute objects when they will no longer be used. Threads that were created with this attribute object will not be affected in any way by this action. Memory that was allocated when it was initialized will be recollected by the system.

Class

Function

Argument Type and Attributes

attr TYPE(f_thread_attr_t), INTENT(IN)

Result Type and Attributes

INTEGER(4)

Result Value

On successful completion, this function returns 0. Otherwise, this function returns the following error.

EINVAL

The argument **attr** is invalid.

f_thread_attr_getdetachstate(attr, detach)

Purpose

This function can be used to query the setting of the detach state attribute in the thread attribute object **attr**. The current setting will be returned through argument **detach**.

Class

Function

Argument Type and Attributes

attr TYPE(f_thread_attr_t), INTENT(IN)

detach INTEGER(4), INTENT(OUT)

Contains one of the following values:

PTHREAD_CREATE_DETACHED:

when a thread attribute object of this attribute setting is used to create a new thread, the newly created thread will be in detached state.

PTHREAD_CREATE_JOINABLE:

when a thread attribute object of this attribute setting is used to create a new thread, the newly created thread will be in undetached state.

Result Type and Attributes

INTEGER(4)

Result Value

On successful completion, this function returns 0. Otherwise, this function returns the following error:

EINVAL

The argument `attr` is invalid.

f_thread_attr_getguardsize(attr, guardsize)

Purpose

This function is used to get the *guardsize* attribute in the thread attribute object *attr*. The current setting of the attribute will be returned through the argument *guardsize*.

Class

Function

Argument Type and Attributes

`attr` TYPE(f_thread_attr_t), INTENT(IN)

`guardsize`

INTEGER(KIND=register_size), INTENT(IN)

where *register_size* is 8.

Result Type and Attributes

INTEGER(4)

Result Value

On successful completion, this function returns 0. Otherwise, this function returns the following error:

EINVAL

The argument `attr` is invalid.

f_thread_attr_getinheritsched(attr, inherit)

Purpose

This function can be used to query the inheritance scheduling attribute in the thread attribute object *attr*. The current setting will be returned through the argument *inherit*.

Class

Function

Argument Type and Attributes

`attr` TYPE(f_thread_attr_t), INTENT(OUT)

inherit

INTEGER(4)

On return from the function, **inherit** contains one of the following values:

PTHREAD_INHERIT_SCHED:

indicating that newly created threads will inherit the scheduling property of the parent thread and ignore the scheduling property of the thread attribute object used to create them.

PTHREAD_EXPLICIT_SCHED:

the scheduling property in the thread attribute object will be assigned to the newly created threads when it is used to create them.

Result Type and Attributes

INTEGER(4)

Result Value

On successful completion, this function returns 0. Otherwise this function returns the following error.

EINVAL

The argument **attr** is invalid.

f_pthread_attr_getschedparam(attr, param)

Purpose

This function can be used to query the scheduling property setting in the thread attribute object **attr**. The current setting will be returned in the argument **param**.

Class

Function

Argument Type and Attributes

attr TYPE(f_pthread_attr_t), INTENT(IN)

param TYPE(f_sched_param), INTENT(OUT)

Result Type and Attributes

INTEGER(4)

Result Value

On successful completion, this function returns 0. Otherwise, this function returns the following error.

EINVAL

The argument **attr** is invalid.

f_thread_attr_getschedpolicy(attr, policy)

Purpose

This function can be used to query the scheduling policy attribute setting in the attribute object **attr**. The current setting of the scheduling policy will be returned in the argument **policy**.

Class

Function

Argument Type and Attributes

attr TYPE(f_thread_attr_t), INTENT(IN)

policy INTEGER(4), INTENT(OUT)

Result Type and Attributes

INTEGER(4)

Result Value

On successful completion, this function returns 0. Otherwise, this function returns the following error.

EINVAL

The argument **attr** is invalid.

f_thread_attr_getscope(attr, scope)

Purpose

This function can be used to query the current setting of the scheduling scope attribute in the thread attribute object **attr**. The current setting will be returned through the argument **scope**.

Class

Function

Argument Type and Attributes

attr TYPE(f_thread_attr_t), INTENT(IN)

scope INTEGER(4), INTENT(OUT)

On return from the function, **scope** will contain one of the following values:

PTHREAD_SCOPE_SYSTEM:

the thread will compete for system resources on a system wide scope.

PTHREAD_SCOPE_PROCESS:

the thread will compete for system resources locally within the owning process.

scope Contains the following value:

PTHREAD_SCOPE_SYSTEM:

the thread will compete for system resources on a system wide scope.

Result Type and Attributes

INTEGER(4)

Result Value

On successful completion, this function returns 0. Otherwise, this function returns the following error.

EINVAL

The argument *attr* is invalid.

f_thread_attr_getstack(attr, stackaddr, ssize)

Purpose

Retrieves the values of the *stackaddr* and *stacksize* arguments from the thread attribute object *attr*.

Class

Function

Argument Type and Attributes

attr TYPE(f_thread_attr_t), INTENT(IN)

stackaddr Integer pointer, INTENT(OUT)

ssize INTEGER(KIND=register_size), INTENT(OUT)
where *register_size* is 8.

Result Type and Attributes

INTEGER(4)

Result Value

On successful completion, this function returns 0. Otherwise, this function returns the following error.

EINVAL

One or more of the supplied arguments is invalid.

f_thread_attr_init(attr)

Purpose

This function must be called to create and initialize the pthread attribute object *attr* before it can be used in any way. It will be filled with system default thread attribute values. After it is initialized, certain pthread attributes can be changed and/or set through attribute access procedures. Once initialized, this attribute object can be used to create a thread with the intended attributes.

Class

Function

Argument Type and Attributes

attr TYPE(f_thread_attr_t), INTENT(OUT)

Result Type and Attributes

INTEGER(4)

Result Value

On successful completion, this function returns 0. Otherwise, this function returns the following error.

EINVAL

The argument **attr** is invalid.

f_thread_attr_setdetachstate(attr, detach)

Purpose

This function can be used to set the detach state attribute in the thread attribute object **attr**.

Class

Function

Argument Type and Attributes

attr TYPE(f_thread_attr_t), INTENT(OUT)

detach INTEGER(4), INTENT(IN)

Must contain one of the following values:

PTHREAD_CREATE_DETACHED:

when a thread attribute object of this attribute setting is used to create a new thread, the newly created thread will be in detached state. This is the system default setting.

PTHREAD_CREATE_JOINABLE:

when a thread attribute object of this attribute setting is used to create a new thread, the newly created thread will be in undetached state.

Result Type and Attributes

INTEGER(4)

Result Value

On successful completion, this function returns 0. Otherwise, this function returns the following error.

EINVAL

The argument **detach** is invalid.

f_thread_attr_setguardsize(attr, guardsize)

Purpose

This function is used to set the **guardsize** attribute in the thread attributes object **attr**. The new value of this attribute is obtained from the argument **guardsize**. If **guardsize** is zero, a guard area will not be provided for threads created with **attr**. If **guardsize** is greater than zero, a guard area of at least size **guardsize** bytes is provided for each thread created with **attr**.

Class

Function

Argument Type and Attributes

attr TYPE(f_thread_attr_t), INTENT(INOUT)

guardsize
 INTEGER(KIND=register_size), INTENT(IN)
 where *register_size* is 8.

Result Type and Attributes

INTEGER(4)

Result Value

On successful completion, this function returns 0. Otherwise, this function returns the following error.

EINVAL

The argument **attr** or the argument **guardsize** is invalid.

f_thread_attr_setinheritsched(attr, inherit)

Purpose

This function can be used to set the inheritance attribute of the thread scheduling property in the thread attribute object **attr**.

Class

Function

Argument Type and Attributes

attr TYPE(f_thread_attr_t), INTENT(OUT)

inherit
 INTEGER(4), INTENT(IN)

Must contain one of the following values:

PTHREAD_INHERIT_SCHED:

indicating that newly created threads will inherit the scheduling property of the parent thread and ignore the scheduling property of the thread attribute object used to create them.

PTHREAD_EXPLICIT_SCHED:

the scheduling property in the thread attribute object will be assigned to the newly created threads when it is used to create them.

Result Type and Attributes

INTEGER(4)

Result Value

On successful completion, this function returns 0. Otherwise, this function returns the following error.

EINVAL

The argument **inherit** is invalid.

f_thread_attr_setschedparam(attr, param)

Purpose

This function can be used to set the scheduling property attribute in the thread attribute object **attr**. Threads created with this new attribute object will assume the scheduling property of argument **param** if they are not inherited from the creating thread. The **sched_priority** field in argument **param** indicates the thread's scheduling priority. The priority field must assume a value in the range of 1-127, where 127 is the most favored scheduling priority while 1 is the least.

Class

Function

Argument Type and Attributes

attr TYPE(f_thread_attr_t), INTENT(INOUT)

param TYPE(f_sched_param), INTENT(IN)

Result Type and Attributes

INTEGER(4)

Result Value

On successful completion, this function returns 0. Otherwise, this function returns the following error.

EINVAL

The argument **param** is invalid.

f_thread_attr_setschedpolicy(attr, policy)

Purpose

After the attribute object is set by this function, threads created with this attribute object will assume the set scheduling policy if the scheduling property is not inherited from the creating thread.

Class

Function

Argument Type and Attributes

attr TYPE(f_thread_attr_t), INTENT(INOUT)

policy INTEGER(4), INTENT(IN)

Must contain one of the following values:

SCHED_FIFO:

indicating a first-in first-out thread scheduling policy.

SCHED_RR:

indicating a round-robin scheduling policy.

SCHED_OTHER:

the default scheduling policy.

Result Type and Attributes

INTEGER(4)

Result Value

On successful completion, this function returns 0. Otherwise, this function returns one of the following error.

EINVAL

The argument **policy** is invalid.

f_thread_attr_setscope(attr, scope)

Purpose

This function can be used to set the contention scope attribute in the thread attribute object **attr**.

Class

Function

Argument Type and Attributes

attr TYPE(f_thread_attr_t), INTENT(INOUT)

scope INTEGER(4), INTENT(IN)

Must contain one of the following values:

PTHREAD_SCOPE_SYSTEM:

the thread will compete for system resources on a system wide scope.

PTHREAD_SCOPE_PROCESS:

the thread will compete for system resources locally within the owning process.

Result Type and Attributes

INTEGER(4)

Result Value

On successful completion, this function returns 0. Otherwise, this function returns the following error.

EINVAL

The argument `scope` is invalid.

f_thread_attr_setstack(attr, stackaddr, ssize)

Purpose

Use this function to set the stack address and stack size attributes in the pthread attribute object `attr`. The `stackaddr` argument represents the stack address as an Integer pointer. The `stacksize` argument is an integer that represents the size of the stack in bytes. When creating a thread using the attribute object `attr`, the system allocates a minimum stack size of `stacksize` bytes.

Class

Function

Argument Type and Attributes

`attr` TYPE(f_thread_attr_t), INTENT(INOUT)

`stackaddr`

Integer pointer, INTENT(IN)

`ssize` INTEGER(KIND=register_size)

where *register_size* is 8.

Result Type and Attributes

INTEGER(4)

Result Value

On successful completion, this function returns 0. Otherwise, this function returns one of the following errors.

EINVAL

The value of one or both of the supplied arguments is invalid.

EACCES

The stack pages specified are not readable by the thread.

f_thread_attr_t

Purpose

A derived data type whose components are all private. Any object of this type should be manipulated only through the appropriate interfaces provided in this module.

This data type corresponds to the POSIX `pthread_attr_t`, which is the type of thread attribute object.

Class

Data Type.

f_thread_cancel(thread)

Purpose

This function can be used to cancel a target thread. How this cancellation request will be processed depends on the state of the cancelability of the target thread. The target thread is identified by argument `thread`. If the target thread is in deferred-cancel state, this cancellation request will be put on hold until the target thread reaches its next cancellation point. If the target thread disables its cancelability, this request will be put on hold until it is enabled again. If the target thread is in async-cancel state, this request will be acted upon immediately.

Class

Function

Argument Type and Attributes

`thread` TYPE(`f_thread_t`), INTENT(INOUT)

Result Type and Attributes

INTEGER(4)

Result Value

On successful completion, this function returns 0. Otherwise, this function returns the following error.

ESRCH

The argument `thread` is invalid.

f_thread_cleanup_pop(exec)

Purpose

This subroutine should be paired with `f_thread_cleanup_push` in using the cleanup stack for thread safety. If the supplied argument `exec` contains a non-zero value, the last pushed cleanup function will be popped from the cleanup stack and executed, with the argument `arg` (from the last `f_thread_cleanup_push`) passed to the cleanup function.

If `exec` contains a zero value, the last pushed cleanup function will be popped from the cleanup stack, but will not be executed.

Class

Subroutine

Argument Type and Attributes

`exec` INTEGER(4), INTENT(IN)

Result Type and Attributes

None.

Result Value

None.

f_pthread_cleanup_push(cleanup, flag, arg)

Purpose

This function can be used to register a cleanup subroutine for the calling thread. In case of an unexpected termination of the calling thread, the system will automatically execute the cleanup subroutine in order for the calling thread to terminate safely. The argument **cleanup** must be a subroutine expecting exactly one argument. If it is executed, the argument **arg** will be passed to it as the actual argument.

The argument **arg** is a generic argument that can be of any type and any rank. The actual argument **arg** must be a variable, and consequently eligible as a left-value in an assignment statement. If you pass an array section with vector subscripts to the argument **arg**, the result is unpredictable.

If the actual argument **arg** is an array section, the corresponding dummy argument in subroutine **cleanup** must be an assumed-shape array. Otherwise, the result is unpredictable.

If the actual argument **arg** has the pointer attribute that points to an array or array section, the corresponding dummy argument in subroutine **cleanup** must have a pointer attribute or be an assumed-shape array. Otherwise, the result is unpredictable.

For a normal execution path, this function must be paired with a call to **f_pthread_cleanup_pop**.

The argument **flag** must be used to convey the property of argument **arg** exactly to the system.

Class

Function

Argument Type and Attributes

cleanup

A subroutine that has one dummy argument.

flag Flag is an INTEGER(4), INTENT(IN) argument that can contain one of, or a combination of, the following constants:

FLAG_CHARACTER:

if the entry subroutine **cleanup** expects an argument of type **CHARACTER** in any way or any form, this flag value must be

included to indicate this fact. However, if the subroutine expects a Fortran 90 pointer pointing to an argument of type **CHARACTER**, the **FLAG_DEFAULT** value should be included instead.

FLAG_ASSUMED_SHAPE:

if the entry subroutine **cleanup** has a dummy argument that is an assumed-shape array of any rank, this flag value must be included to indicate this fact.

FLAG_DEFAULT:

otherwise, this flag value is needed.

arg A generic argument that can be of any type, kind, and rank.

Result Type and Attributes

INTEGER(4)

Result Value

On successful completion, this function returns 0. Otherwise, this function returns one of the following errors.

ENOMEM

The system cannot allocate memory to push this routine.

EAGAIN

The system cannot allocate resources to push this routine.

EINVAL

The argument **flag** is invalid.

f_thread_cond_broadcast(cond)

Purpose

This function will unblock all threads waiting on the condition variable **cond**. If there is no thread waiting on this condition variable, the function will still succeed, but the next caller to **f_thread_cond_wait** will be blocked, and will wait on the condition variable **cond**.

Class

Function

Argument Type and Attributes

cond TYPE(f_thread_cond_t), INTENT(INOUT)

Result Type and Attributes

INTEGER(4)

Result Value

On successful completion, this function returns 0. Otherwise, this function returns following error.

EINVAL

The argument **cond** is invalid.

f_thread_cond_destroy(cond)

Purpose

This function can be used to destroy those condition variables that are no longer required. The target condition variable is identified by the argument **cond**. System resources allocated during initialization will be recollected by the system.

Class

Function

Argument Type and Attributes

cond TYPE(f_thread_cond_t), INTENT(INOUT)

Result Type and Attributes

INTEGER(4)

Result Value

On successful completion, this function returns 0. Otherwise, this function returns the following error.

EBUSY

The condition variable **cond** is being used by another thread.

f_thread_cond_init(cond, cattr)

Purpose

This function can be used to dynamically initialize a condition variable **cond**. Its attributes will be set according to the attribute object **cattr**, if it is provided; otherwise, its attributes will be set to the system default. After the condition variable is initialized successfully, it can be used to synchronize threads.

Another method of initializing a condition variable is to initialize it statically using the Fortran constant **PTHREAD_COND_INITIALIZER**.

Class

Function

Argument Type and Attributes

cond TYPE(f_thread_cond_t), INTENT(INOUT)

cattr TYPE(f_thread_condattr_t), INTENT(IN), OPTIONAL

Result Type and Attributes

INTEGER(4)

Result Value

On successful completion, this function returns 0. Otherwise, this function returns one of the following errors.

EBUSY

The condition variable is already in use. It is initialized and not destroyed.

EINVAL

The argument **cond** or **cattr** is invalid.

f_thread_cond_signal(cond)

Purpose

This function will unblock at least one thread waiting on the condition variable **cond**. If there is no thread waiting on this condition variable, the function will still succeed, but the next caller to **f_thread_cond_wait** will be blocked, and will wait on the condition variable **cond**.

Class

Function

Argument Type and Attributes

cond TYPE(f_thread_cond_t), INTENT(INOUT)

Result Type and Attributes

INTEGER(4)

Result Value

On successful completion, this function returns 0. Otherwise, this function returns the following error.

EINVAL

The argument **cond** is invalid.

f_thread_cond_t

Purpose

A derived data type whose components are all private. Any object of this type should be manipulated through the appropriate interfaces provided in this module. In addition, objects of this type can be initialized at compile time using the Fortran constant **PTHREAD_COND_INITIALIZER**.

This data type corresponds to the POSIX **pthread_cond_t**, which is the type of condition variable object.

Class

Data Type.

f_thread_cond_timedwait(cond, mutex, timeout)

Purpose

This function can be used to wait for a certain condition to occur. The argument **mutex** must be locked before calling this function. The mutex is unlocked atomically and the calling thread waits for the condition to occur. The argument **timeout** specifies a deadline before which the condition must occur. If the deadline

is reached before the condition occurs, the function will return an error code. This function provides a cancelation point in that the calling thread can be canceled if it is in the enabled state.

The argument **timeout** will specify an absolute date of the form: Oct. 31 10:00:53, 1998. For related information, see **f_maketime** and **f_timespec**.

Class

Function

Argument Type and Attributes

cond TYPE(f_thread_cond_t), INTENT(INOUT)

mutex TYPE(f_thread_mutex_t), INTENT(INOUT)

timeout
TYPE(f_timespec), INTENT(IN)

Result Type and Attributes

INTEGER(4)

Result Value

On successful completion, this function returns 0. Otherwise this function returns one of the following errors:

EINVAL

The argument **cond**, **mutex**, or **timeout** is invalid.

ETIMEDOUT

The waiting deadline was reached before the condition occurred.

f_thread_cond_wait(cond, mutex)

Purpose

This function can be used to wait for a certain condition to occur. The argument **mutex** must be locked before calling this function. The mutex is unlocked atomically, and the calling thread waits for the condition to occur. If the condition does not occur, the function will wait until the calling thread is terminated in another way. This function provides a cancelation point in that the calling thread can be canceled if it is in the enabled state.

Class

Function

Argument Type and Attributes

cond TYPE(f_thread_cond_t), INTENT(INOUT)

mutex TYPE(f_thread_mutex_t), INTENT(INOUT)

Result Type and Attributes

INTEGER(4)

Result Value

This function returns 0.

f_thread_condattr_destroy(cattr)

Purpose

This function can be called to destroy the condition variable attribute objects that are no longer required. The target object is identified by the argument **cattr**. The system resources allocated when it is initialized will be recollected.

Class

Function

Argument Type and Attributes

cattr TYPE(f_thread_condattr_t), INTENT(INOUT)

Result Type and Attributes

INTEGER(4)

Result Value

On successful completion, this function returns 0. Otherwise, this function returns one of the following errors.

EINVAL

The argument **cattr** is invalid.

EBUSY

Returns **EBUSY** if threads are waiting on the for the condition to occur.

f_thread_condattr_getpshared(cattr, pshared)

Purpose

This function can be used to query the process-shared attribute of the condition variable attributes object identified by the argument **cattr**. The current setting of this attribute will be returned in the argument **pshared**.

Class

Function

Argument Type and Attributes

cattr TYPE(f_thread_condattr_t), INTENT(IN)

pshared

INTEGER(4), INTENT(OUT)

On successful completion, **pshared** contains one of the following values:

PTHREAD_PROCESS_SHARED

The condition variable can be used by any thread that has access to the memory where it is allocated, even if these threads belong to different processes.

PTHREAD_PROCESS_PRIVATE

The condition variable shall only be used by threads within the same process as the thread that created it.

Result Type and Attributes

INTEGER(4)

Result Value

On successful completion, this function returns 0. Otherwise, this function returns the following error.

EINVAL

The argument `cattr` is invalid.

f_pthread_condattr_init(cattr)

Purpose

Use this function to initialize a condition variable attributes object `cattr` with the default value for all of the attributes defined by the implementation. Attempting to initialize an already initialized condition variable attributes object results in undefined behavior. After a condition variable attributes object has been used to initialize one or more condition variables, any function affecting the attributes object (including destruction) does not affect any previously initialized condition variables.

Class

Function

Argument Type and Attributes

`cattr` TYPE(f_pthread_condattr_t), INTENT(OUT)

Result Type and Attributes

INTEGER(4)

Result Value

On successful completion, this function returns 0. Otherwise, this function returns the following error.

ENOMEM

There is insufficient memory to initialize the condition variable attributes object.

f_pthread_condattr_setpshared(cattr, pshared)

Purpose

This function is used to set the process-shared attribute of the condition variable attributes object identified by the argument `cattr`. Its process-shared attribute will be set according to the argument `pshared`.

Class

Function

Argument Type and Attributes

cattr TYPE(f_thread_condattr_t), INTENT(INOUT)

pshared

is an INTEGER(4), INTENT(IN) argument that must contain one of the following values:

PTHREAD_PROCESS_SHARED

Specifies that the condition variable can be used by any thread that has access to the memory where it is allocated, even if these threads belong to different processes.

PTHREAD_PROCESS_PRIVATE

Specifies that the condition variable shall only be used by threads within the same process as the thread that created it. This is the default setting of the attribute.

Result Type and Attributes

INTEGER(4)

Result Value

On successful completion, this function returns 0. Otherwise, this function returns the following error.

EINVAL

The value specified by the argument **cattr** or **pshared** is invalid.

f_thread_condattr_t

Purpose

A derived data type whose components are all private. Any object of this type should be manipulated only through the appropriate interfaces provided in this module.

This data type corresponds to the POSIX **pthread_condattr_t**, which is the type of condition variable attribute object.

Class

Data Type

f_thread_create(thread, attr, flag, ent, arg)

Purpose

This function is used to create a new thread in the current process. The newly created thread will assume the attributes defined in the thread attribute object **attr**, if it is provided. Otherwise, the new thread will have system default attributes. The new thread will begin execution at the subroutine **ent**, which is required to have one dummy argument. The system will pass the argument **arg** to the thread entry subroutine **ent** as its actual argument. The argument **flag** is used to inform

the system of the property of the argument **arg**. When the execution returns from the entry subroutine **ent**, the new thread will terminate automatically.

If subroutine **ent** was declared such that an explicit interface would be required if it was called directly, then an explicit interface is also required when it is passed as an argument to this function.

The argument **arg** is a generic argument that can be of any type and any rank. The actual argument **arg** must be a variable, and consequently eligible as a left- value in an assignment statement. If you pass an array section with vector subscripts to the argument **arg**, the result is unpredictable.

If the actual argument **arg** is an array section, the corresponding dummy argument in subroutine **ent** must be an assumed-shape array. Otherwise, the result is unpredictable.

If the actual argument **arg** has the pointer attribute that points to an array or array section, the corresponding dummy argument in subroutine **ent** must have a pointer attribute or be an assumed-shape array. Otherwise, the result is unpredictable.

Class

Function

Argument Type and Attributes

thread TYPE(f_thread_t), INTENT(OUT)

On successful completion of the function, **f_thread_create** stores the ID of the created thread in the **thread**.

attr TYPE(f_thread_attr_t), INTENT(IN)

flag INTEGER(4), INTENT(IN)

The argument **flag** must convey the property of the argument **arg** exactly to the system. The argument **flag** can be one of, or a combination of, the following constants:

FLAG_CHARACTER:

if the entry subroutine **ent** expects an argument of type **CHARACTER** in any way or any form, this flag value must be included to indicate this fact. However, if the subroutine expects a Fortran 90 pointer pointing to an argument of type **CHARACTER**, the **FLAG_DEFAULT** value should be included instead.

FLAG_ASSUMED_SHAPE:

if the entry subroutine **ent** has a dummy argument which is an assumed-shape array of any rank, this flag value must be included to indicate this fact.

FLAG_DEFAULT:

otherwise, this flag value is needed.

ent A subroutine that has one dummy argument of any type, kind and rank.

arg A generic argument of any type, kind, and rank. It is passed to **ent** as the only actual argument.

Result Type and Attributes

INTEGER(4)

Result Value

On successful completion, this function returns 0. Otherwise, this function returns one of the following errors.

EAGAIN

The system does not have enough resources to create a new thread.

EINVAL

The argument **thread**, **attr**, or **flag** is invalid.

ENOMEM

The system does not have sufficient memory to create a new thread.

f_thread_detach(thread)

Purpose

This function is used to indicate to the pthreads library implementation that storage for the thread whose thread ID is specified by the argument **thread** can be claimed when this thread terminates. If the thread has not yet terminated, **f_thread_detach** shall not cause it to terminate. Multiple **f_thread_detach** calls on the same target thread cause an error.

Class

Function

Argument Type and Attributes

thread TYPE(f_thread_t), INTENT(IN)

Result Type and Attributes

INTEGER(4)

Result Value

On successful completion, this function returns 0. Otherwise, this function returns the following error.

ESRCH

The argument **thread** is invalid.

f_thread_equal(thread1, thread2)

Purpose

This function can be used to compare whether two thread ID's identify the same thread or not.

Class

Function

Argument Type and Attributes

thread1

TYPE(f_thread_t), INTENT(IN)

thread2

TYPE(f_thread_t), INTENT(IN)

Result Type and Attributes

LOGICAL(4)

Result Value

TRUE The two thread ID's identify the same thread.

FALSE

The two thread ID's do not identify the same thread.

f_thread_exit(ret)

Purpose

This subroutine can be called explicitly to terminate the calling thread before it returns from the entry subroutine. The actions taken depend on the state of the calling thread. If it is in non-detached state, the calling thread will wait to be joined. If the thread is in detached state, or when it is joined by another thread, the calling thread will terminate safely. First, the cleanup stack will be popped and executed, and then any thread-specific data will be destructed by the destructors. Finally, the thread resources are freed and the argument **ret** will be returned to the joining threads. The argument **ret** of this subroutine is optional. Currently, argument **ret** is limited to be an Integer pointer. If it is not an Integer pointer, the behavior is undefined. Calling **f_thread_exit** will not automatically free all of the memory allocated to a thread. To avoid memory leaks, finalization must be handled separately from **f_thread_exit**.

This subroutine never returns. If argument **ret** is not provided, NULL will be provided as this thread's exit status.

Class

Subroutine

Argument Type and Attributes

ret Integer pointer, OPTIONAL, INTENT(IN)

Result Type and Attributes

None

Result Value

None

f_thread_getconcurrency()

Purpose

This function returns the value of the concurrency level set by a previous call to the `f_thread_setconcurrency` function. If the `f_thread_setconcurrency` function was not previously called, this function returns zero to indicate that the system is maintaining the concurrency level.

Class

Function

Argument Type and Attributes

None

Result Type and Attributes

INTEGER(4)

Result Value

This function returns the value of the concurrency level set by a previous call to the `f_thread_setconcurrency` function. If the `f_thread_setconcurrency` function was not previously called, this function returns 0.

f_thread_getschedparam(thread, policy, param)

Purpose

This function can be used to query the current setting of the scheduling property of the target thread. The target thread is identified by argument `thread`. Its scheduling policy will be returned through argument `policy` and its scheduling property through argument `param`. The `sched_priority` field in `param` defines the scheduling priority. The priority field will assume a value in the range of 1-127, where 127 is the most favored scheduling priority while 1 is the least.

Class

Function

Argument Type and Attributes

`thread` TYPE(f_thread_t), INTENT(IN)

`policy` INTEGER(4), INTENT(OUT)

`param` TYPE(f_sched_param), INTENT(OUT)

Result Type and Attributes

INTEGER(4)

Result Value

On successful completion, this function returns 0. Otherwise, this function returns one of the following errors.

ESRCH

The target thread is invalid or has already terminated.

EFAULT

The `policy` or `param` points are outside the process memory space

f_pthread_getspecific(key, arg)

Purpose

This function can be used to retrieve the thread-specific data associated with `key`. Note that the argument `arg` is not optional in this function as it will return the thread-specific data. After execution of the procedure, the argument `arg` holds a pointer to the data, or `NULL` if there is no data to retrieve. The argument `arg` must be an Integer pointer, or the result is undefined.

The actual argument `arg` must be a variable, and consequently eligible as a left-value in an assignment statement. If you pass an array section with vector subscripts to the argument `arg`, the result is unpredictable.

Class

Function

Argument Type and Attributes

`key` TYPE(f_pthread_key_t), INTENT(IN)

`arg` Integer pointer, INTENT(OUT)

Result Type and Attributes

INTEGER(4)

Result Value

On successful completion, this function returns 0. Otherwise, this function returns the following error.

EINVAL

The argument `key` is invalid.

f_pthread_join(thread, ret)

Purpose

This function can be called to join a particular thread designated by the argument `thread`. If the target thread is in non-detached state and is already terminated, this call will return immediately with the target thread's status returned in argument `ret` if it is provided. The argument `ret` is optional. Currently, `ret` must be an Integer pointer if it is provided.

If the target thread is in detached state, it is an error to join it.

Class

Function

Argument Type and Attributes

thread TYPE(f_thread_t), INTENT(IN)

ret Integer pointer, INTENT(OUT), OPTIONAL

Result Type and Attributes

INTEGER(4)

Result Value

On successful completion, this function returns 0. Otherwise, this function returns one of the following errors.

EDEADLK

This call will cause a deadlock, or the calling thread is trying to join itself.

EINVAL

The argument **thread** is invalid.

ESRCH

The argument **thread** designates a thread which does not exist or is in detached state.

f_thread_key_create(key, dtr)

Purpose

This function can be used to acquire a thread-specific data key. The key will be returned in the argument **key**. The argument **dtr** is a subroutine that will be used to destruct the thread-specific data associated with this key when any thread terminates after this calling point. The destructor will receive the thread-specific data as its argument. The destructor itself is optional. If it is not provided, the system will not invoke any destructor on the thread-specific data associated with this key. Note that the number of thread-specific data keys is limited in each process. It is the user's responsibility to manage the usage of the keys. The per-process limit can be checked by the Fortran constant **PTHREAD_DATAKEYS_MAX**.

Class

Function

Argument Type and Attributes

key TYPE(f_thread_key_t), INTENT(OUT)

dtr External, optional subroutine

Result Type and Attributes

INTEGER(4)

Result Value

On successful completion, this function returns 0. Otherwise, this function returns one of the following errors.

EAGAIN

The maximum number of keys has been exceeded.

EINVAL

The argument **key** is invalid.

ENOMEM

There is insufficient memory to create this key.

f_pthread_key_delete(key)**Purpose**

This function will destroy the thread-specific data key identified by the argument **key**. It is the user's responsibility to ensure that there is no thread-specific data associated with this key. This function does not call any destructor on the thread's behalf. After the key is destroyed, it can be reused by the system for **f_pthread_key_create** requests.

Class

Function

Argument Type and Attributes

key TYPE(f_pthread_key_t), INTENT(INOUT)

Result Type and Attributes

INTEGER(4)

Result Value

On successful completion, this function returns 0. Otherwise, this function returns one of the following errors.

EINVAL

The argument **key** is invalid.

EBUSY

There is still data associated with this key.

f_pthread_key_t**Purpose**

A derived data type whose components are all private. Any object of this type should be manipulated only through the appropriate interfaces provided in this module.

This data type corresponds to the POSIX **pthread_key_t**, which is the type of key object for accessing thread-specific data.

Class

Data Type

f_pthread_kill(thread, sig)

Purpose

This function can be used to send a signal to a target thread. The target thread is identified by argument **thread**. The signal which will be sent to the target thread is identified in argument **sig**. If **sig** contains value zero, error checking will be done by the system but no signal will be sent.

Class

Function

Argument Type and Attributes

thread TYPE(f_pthread_t), INTENT(INOUT)

sig INTEGER(4), INTENT(IN)

Result Type and Attributes

INTEGER(4)

Result Value

On successful completion, this function returns 0. Otherwise, this function returns one of the following errors.

EINVAL

The argument **thread** or **sig** is invalid.

ESRCH

The target thread does not exist.

f_pthread_mutex_destroy(mutex)

Purpose

This function should be called to destroy those mutex objects that are no longer required. In this way, the system can recollect the memory resources. The target mutex object is identified by the argument **mutex**.

Class

Function

Argument Type and Attributes

mutex TYPE(f_pthread_mutex_t), INTENT(INOUT)

Result Type and Attributes

INTEGER(4)

Result Value

On successful completion, this function returns 0. Otherwise, this function returns one of the following errors.

EBUSY

The target mutex is locked or referenced by another thread.

EINVAL

The argument **mutex** is invalid.

f_thread_mutex_init(mutex, mattr)

Purpose

This function can be used to initialize the mutex object identified by argument **mutex**. The initialized mutex will assume attributes set in the mutex attribute object **mattr**, if it is provided. If **mattr** is not provided, the system will initialize the mutex to have default attributes. After it is initialized, the mutex object can be used to synchronize accesses to critical data or code. It can also be used to build more complicated thread synchronization objects.

Another method to initialize mutex objects is to statically initialize them through the Fortran constant **PTHREAD_MUTEX_INITIALIZER**. If this method of initialization is used it is not necessary to call the function before using the mutex objects.

Class

Function

Argument Type and Attributes

mutex TYPE(f_thread_mutex_t), INTENT(OUT)

mattr TYPE(f_thread_mutexattr_t), INTENT(IN), OPTIONAL

Result Type and Attributes

INTEGER(4)

Result Value

This function always returns 0.

f_thread_mutex_lock(mutex)

Purpose

This function can be used to acquire ownership of the mutex object. (In other words, the function will lock the mutex.) If the mutex has already been locked by another thread, the caller will wait until the mutex is unlocked. If the mutex is already locked by the caller itself, an error will be returned to prevent recursive locking.

Class

Function

Argument Type and Attributes

mutex TYPE(f_thread_mutex_t), INTENT(INOUT)

Result Type and Attributes

INTEGER(4)

Result Value

On successful completion, this function returns 0. Otherwise, this function returns one of the following errors.

EDEADLK

The mutex is locked by the calling thread already.

EINVAL

The argument **mutex** is invalid.

f_thread_mutex_t

Purpose

A derived data type whose components are all private. Any object of this type should be manipulated through the appropriate interfaces provided in this module. In addition, objects of this type can be initialized statically through the Fortran constant **PTHREAD_MUTEX_INITIALIZER**.

This data type corresponds to the POSIX **pthread_mutex_t**, which is the type of mutex object.

Class

Data Type

f_thread_mutex_trylock(mutex)

Purpose

This function can be used to acquire ownership of the mutex object. (In other words, the function will lock the mutex.) If the mutex has already been locked by another thread, the function returns the error code **EBUSY**. The calling thread can check the return code to take further actions. If the mutex is already locked by the caller itself, an error will be returned to prevent recursive locking.

Class

Function

Argument Type and Attributes

mutex TYPE(f_thread_mutex_t), INTENT(INOUT)

Result Type and Attributes

INTEGER(4)

Result Value

On successful completion, this function returns 0. Otherwise, this function returns one of the following errors.

EBUSY

The target mutex is locked or referenced by another thread.

EINVAL

The argument **mutex** is invalid.

f_thread_mutex_unlock(mutex)

Purpose

This function releases the mutex object's ownership in order to allow other threads to lock the mutex.

Class

Function

Argument Type and Attributes

mutex TYPE(f_thread_mutex_t), INTENT(INOUT)

Result Type and Attributes

INTEGER(4)

Result Value

On successful completion, this function returns 0. Otherwise, this function returns one of the following errors.

EINVAL

The argument **mutex** is invalid.

EPERM

The mutex is not locked by the calling thread.

f_thread_mutexattr_destroy(mattr)

Purpose

This function can be used to destroy a mutex attribute object that has been initialized previously. Allocated memory will then be recollected. A mutex created with this attribute will not be affected by this action.

Class

Function

Argument Type and Attributes

mattr TYPE(f_thread_mutexattr_t), INTENT(INOUT)

Result Type and Attributes

INTEGER(4)

Result Value

This function always returns 0.

f_pthread_mutexattr_getshared(mattr, pshared)

Purpose

This function is used to query the process-shared attribute in the mutex attributes object identified by the argument **mattr**. The current setting of the attribute will be returned through the argument **pshared**.

Class

Function

Argument Type and Attributes

mattr TYPE(f_pthread_mutexattr_t), INTENT(IN)

pshared

INTEGER(4), INTENT(IN)

On return from this function, **pshared** contains one of the following values:

PTHREAD_PROCESS_SHARED

The mutex can be operated upon by any thread that has access to the memory where the mutex is allocated, even if the mutex is allocated in memory that is shared by multiple processes.

PTHREAD_PROCESS_PRIVATE

The mutex will only be operated upon by threads created within the same process as the thread that initialized the mutex.

Result Type and Attributes

INTEGER(4)

Result Value

If this function completes successfully, value 0 is returned and the value of the process-shared attribute is returned through the argument **pshared**. Otherwise, the following error will be returned:

EINVAL

The argument **mattr** is invalid.

f_pthread_mutexattr_gettype(mattr, type)

Purpose

This function is used to query the mutex type attribute in the mutex attributes object identified by the argument **mattr**.

If this function completes successfully, value 0 is returned and the type attribute will be returned through the argument **type**.

Class

Function

Argument Type and Attributes

mattr TYPE(f_pthread_mutexattr_t), INTENT(IN)

type INTEGER(4), INTENT(OUT)

On return from this function, **type** contains one of the following values:

PTHREAD_MUTEX_NORMAL

This type of mutex does not detect deadlock. A thread attempting to relock this mutex without first unlocking it will deadlock. Attempting to unlock a mutex locked by a different thread results in undefined behavior.

PTHREAD_MUTEX_ERRORCHECK

This type of mutex provides error checking. A thread attempting to relock this mutex without first unlocking it will return with an error. A thread attempting to unlock a mutex which another thread has locked will return an error. A thread attempting to unlock an unlocked mutex will return with an error.

PTHREAD_MUTEX_RECURSIVE

A thread attempting to relock this mutex without first unlocking it will succeed in locking the mutex. The relocking deadlock that can occur with mutexes of type **PTHREAD_MUTEX_NORMAL** cannot occur with this type of mutex. Multiple locks of this mutex require the same number of unlocks to release the mutex before another thread can acquire the mutex.

Result Type and Attributes

INTEGER(4)

Result Value

On successful completion, this function returns 0. Otherwise, this function returns the following error.

EINVAL

The argument is invalid.

f_pthread_mutexattr_init(mattr)

Purpose

This function can be used to initialize a mutex attribute object before it can be used in any other way. The mutex attribute object will be returned through argument **mattr**.

Class

Function

Argument Type and Attributes

mattr TYPE(f_pthread_mutexattr_t), INTENT(OUT)

Result Type and Attributes

INTEGER(4)

Result Value

This function returns 0.

f_pthread_mutexattr_setshared(mattr, pshared)

Purpose

This function is used to set the process-shared attribute of the mutex attributes object identified by the argument **mattr**.

Class

Function

Argument Type and Attributes

mattr TYPE(f_pthread_mutexattr_t), INTENT(INOUT)

pshared

INTEGER(4), INTENT(IN)

Must contain one of the following values:

PTHREAD_PROCESS_SHARED

Specifies the mutex can be operated upon by any thread that has access to the memory where the mutex is allocated, even if the mutex is allocated in memory that is shared by multiple processes.

PTHREAD_PROCESS_PRIVATE

Specifies the mutex will only be operated upon by threads created within the same process as the thread that initialized the mutex. This is the default setting of the attribute.

Result Type and Attributes

INTEGER(4)

Result Value

On successful completion, this function returns 0. Otherwise, this function returns the following error.

EINVAL

The argument is invalid.

f_pthread_mutexattr_settype(mattr, type)

Purpose

This function is used to set the mutex type attribute in the mutex attributes object identified by the argument **mattr**. The argument type identifies the mutex type attribute to be set.

Class

Function

Argument Type and Attributes

mutex TYPE(f_thread_mutexattr_t), INTENT(INOUT)

type INTEGER(4), INTENT(IN)

Must contain one of the following values:

PTHREAD_MUTEX_NORMAL

This type of mutex does not detect deadlock. A thread attempting to relock this mutex without first unlocking it will deadlock. Attempting to unlock a mutex locked by a different thread results in undefined behavior.

PTHREAD_MUTEX_ERRORCHECK

This type of mutex provides error checking. A thread attempting to relock this mutex without first unlocking it will return with an error. A thread attempting to unlock a mutex which another thread has locked will return an error. A thread attempting to unlock an unlocked mutex will return with an error.

PTHREAD_MUTEX_RECURSIVE

A thread attempting to relock this mutex without first unlocking it will succeed in locking the mutex. The relocking deadlock that can occur with mutexes of type **PTHREAD_MUTEX_NORMAL** cannot occur with this type of mutex. Multiple locks of this mutex require the same number of unlocks to release the mutex before another thread can acquire the mutex.

PTHREAD_MUTEX_DEFAULT

The same as **PTHREAD_MUTEX_NORMAL**.

Result Type and Attributes

INTEGER(4)

Result Value

On successful completion, this function returns 0. Otherwise, this function returns the following error.

EINVAL

One of the arguments is invalid.

f_thread_mutexattr_t

Purpose

A derived data type whose components are all private. Any object of this type should be manipulated only through the appropriate interfaces provided in this module.

This data type corresponds to the POSIX **pthread_mutexattr_t**, which is the type of mutex attribute object.

Class

Data Type

f_thread_once(once, initr)

Purpose

This function can be used to initialize those data required to be initialized only once. The first thread calling this function will call **initr** to do the initialization. Other threads calling this function afterwards will have no effect. Argument **initr** must be a subroutine without dummy arguments.

Class

Function

Argument Type and Attributes

once TYPE(f_thread_once_t), INTENT(INOUT)

initr A subroutine that has no dummy arguments.

Result Type and Attributes

INTEGER(4)

Result Value

This function returns 0.

f_thread_once_t

Purpose

A derived data type whose components are all private. Any object of this type should be manipulated through the appropriate interfaces provided in this module. However, objects of this type can *only* be initialized through the Fortran constant **PTHREAD_ONCE_INIT**.

Class

Data Type

f_thread_rwlock_destroy(rwlock)

Purpose

This function destroys the read-write lock object specified by the argument **rwlock** and releases any resources used by the lock.

Class

Function

Argument Type and Attributes

rwlock
TYPE(f_thread_rwlock_t), INTENT(INOUT)

Result Type and Attributes

INTEGER(4)

Result Value

On successful completion, this function returns 0. Otherwise, this function returns one of the following errors.

EBUSY

The target read-write object is locked.

f_thread_rwlock_init(rwlock, rwattr)

Purpose

This function initializes the read-write lock object specified by **rwlock** with the attribute specified by the argument **rwattr**. If the optional argument **rwattr** is not provided, the system will initialize the read-write lock object with the default attributes. After it is initialized, the lock can be used to synchronize access to critical data. With a read-write lock, many threads can have simultaneous read-only access to data, while only one thread can have write access at any given time and no other readers or writers are allowed.

Another method to initialize read-write lock objects is to statically initialize them through the Fortran constant **PTHREAD_RWLOCK_INITIALIZER**. If this method of initialization is used, it is not necessary to call this function before using the read-write lock objects.

Class

Function

Argument Type and Attributes

rwlock

TYPE(f_thread_rwlock_t), INTENT(OUT)

rwattr TYPE(f_thread_rwlockattr_t), INTENT(IN), OPTIONAL

Result Type and Attributes

INTEGER(4)

Result Value

This function returns 0.

f_thread_rwlock_rdlock(rwlock)

Purpose

This function applies a read lock to the read-write lock specified by the argument **rwlock**. The calling thread acquires the read lock if a writer does not hold the lock and there are no writes blocked on the lock. Otherwise, the calling thread will not acquire the read lock. If the read lock is not acquired, the calling thread blocks (that is, it does not return from the **f_thread_rwlock_rdlock** call) until it can acquire the lock. Results are undefined if the calling thread holds a write lock on **rwlock** at the time the call is made. A thread may hold multiple concurrent read locks on **rwlock** (that is, successfully call the **f_thread_rwlock_rdlock** function n times). If so, the thread must perform matching unlocks (that is, it must call the **f_thread_rwlock_unlock** function n times).

Class

Function

Argument Type and Attributes

rwlock

TYPE(f_thread_rwlock_t), INTENT(INOUT)

Result Type and Attributes

INTEGER(4)

Result Value

On successful completion, this function returns 0. Otherwise, this function returns one of the following errors.

EAGAIN

The read-write lock could not be acquired because the maximum number of read locks for **rwlock** has been exceeded.

EINVAL

The argument **rwlock** does not refer to an initialized read-write lock object.

f_thread_rwlock_t

Purpose

A derived data type whose components are all private. Any object of this type should be manipulated only through the appropriate interfaces provided in this module. In addition, objects of this type can be initialized statically through the Fortran constant **PTHREAD_RWLOCK_INITIALIZER**.

Class

Data Type

f_thread_rwlock_tryrdlock(rwlock)

Purpose

This function applies a read lock like the **f_thread_rwlock_rdlock** function with the exception that the function fails if any thread holds a write lock on **rwlock** or there are writers blocked on **rwlock**. In that case, the function returns **EBUSY**. The calling thread can check the return code to take further actions.

Class

Function

Argument Type and Attributes

rwlock

TYPE(f_thread_rwlock_t), INTENT(INOUT)

Result Type and Attributes

INTEGER(4)

Result Value

This function returns zero if the lock for reading on the read-write lock object specified by **rwlock** is acquired. Otherwise, the following error will be returned:

EBUSY

The read-write lock could not be acquired for reading because a writer holds the lock or was blocked on it.

f_pthread_rwlock_trywrlock(rwlock)

Purpose

This function applies a write lock like the **f_pthread_rwlock_wrlock** function with the exception that the function fails if any thread currently holds **rwlock** (for reading or writing). In that case, the function returns **EBUSY**. The calling thread can check the return code to take further actions.

Class

Function

Argument Type and Attributes

rwlock

TYPE(f_pthread_rwlock_t), INTENT(INOUT)

Result Type and Attributes

INTEGER(4)

Result Value

This function returns zero if the lock for writing on the read-write lock object specified by **rwlock** is acquired. Otherwise, the following error will be returned:

EBUSY

The read-write lock could not be acquired for writing because it is already locked for reading or writing.

f_pthread_rwlock_unlock(rwlock)

Purpose

This function is used to release a lock held on the read-write lock object specified by the argument *rwlock*. If this function is called to release a read lock from the read-write lock object and there are other read locks currently held on this read-write lock object, the read-write lock object remains in the read locked state. If this function releases the calling thread's last read lock on this read-write lock object, then the calling thread is no longer one of the owners of the object. If this function releases the last read lock for this read-write lock object, the read-write lock object will be put in the unlocked state with no owners.

Class

Function

Argument Type and Attributes

rwlock

TYPE(*f_thread_rwlock_t*), INTENT(INOUT)

Result Type and Attributes

INTEGER(4)

Result Value

On successful completion, this function returns 0. Otherwise, this function returns one of the following errors.

EPERM

The current thread does not own the read-write lock.

f_thread_rwlock_wrlock(*rwlock*)

Purpose

This function applies a write lock to the read-write lock specified by the argument *rwlock*. The calling thread acquires the write lock if no other thread (reader or writer) holds the read-write lock *rwlock*. Otherwise, the thread blocks (that is, does not return from the **f_thread_rwlock_wrlock** call) until it acquires the lock. Results are undefined if the calling thread holds the read-write lock (whether a read or write lock) at the time the call is made.

Class

Function

Argument Type and Attributes

rwlock

TYPE(*f_thread_rwlock_t*), INTENT(INOUT)

Result Type and Attributes

INTEGER(4)

Result Value

On successful completion, this function returns 0. Otherwise, this function returns the following error.

EINVAL

The argument *rwlock* does not refer to an initialized read-write lock object.

f_thread_rwlockattr_destroy(*rwattr*)

Purpose

This function destroys a read-write lock attributes object specified by the argument *rwattr* which has been initialized previously. A read-write lock created with this attribute will not be affected by the action.

Class

Function

Argument Type and Attributes

rwattr TYPE(f_thread_rwlockattr_t), INTENT(INOUT)

Result Type and Attributes

INTEGER(4)

Result Value

On successful completion, this function returns 0. Otherwise, this function returns the following error.

EINVAL

The argument **rwattr** is invalid.

f_thread_rwlockattr_getpshared(rwattr, pshared)

Purpose

This function is used to obtain the value of the process-shared attribute from the initialized read-write lock attributes object specified by the argument **rwattr**. The current setting of this attribute will be returned in the argument **pshared**.

Class

Function

Argument Type and Attributes

rwattr TYPE(f_thread_rwlockattr_t), INTENT(IN)

pshared

INTEGER(4), INTENT(OUT)

On return from this function, the value of **pshared** will be one of the following values:

PTHREAD_PROCESS_SHARED

The read-write lock can be operated upon by any thread that has access to the memory where it is allocated, even if these threads belong to different processes.

PTHREAD_PROCESS_PRIVATE

The read-write lock shall only be used by threads within the same process as the thread that created it.

Result Type and Attributes

INTEGER(4)

Result Value

If this function completes successfully, value 0 is returned and the value of the process-shared attribute of **rwattr** is stored into the object specified by the argument **pshared**. Otherwise, the following error will be returned:

EINVAL

The argument *rwattr* is invalid.

f_thread_rwlockattr_init(rwattr)

Purpose

This function initializes a read-write lock attributes object specified by *rwattr* with the default value for all of the attributes.

Class

Function

Argument Type and Attributes

rwattr TYPE(f_thread_rwlockattr_t), INTENT(OUT)

Result Type and Attributes

INTEGER(4)

Result Value

On successful completion, this function returns 0. Otherwise, this function returns the following error.

ENOMEM

There is insufficient memory to initialize the read-write lock attributes object.

f_thread_rwlockattr_setpshared(rwattr, pshared)

Purpose

This function is used to set the process-shared attribute in an initialized read-write lock attributes object specified by the argument *rwattr*, based on the value provided by the argument *pshared*.

Class

Function

Argument Type and Attributes

rwattr TYPE(f_thread_rwlockattr_t), INTENT(INOUT)

pshared

INTEGER(4), INTENT(IN)

Must be one of the following values:

PTHREAD_PROCESS_SHARED

Specifies the read-write lock can be operated upon by any thread that has access to the memory where it is allocated, even if these threads belong to different processes.

PTHREAD_PROCESS_PRIVATE

Specifies the read-write lock shall only be used by threads within the same process as the thread that created it. This is the default setting of the attribute.

Result Type and Attributes

INTEGER(4)

Result Value

On successful completion, this function returns 0. Otherwise, this function returns one of the following errors:

EINVAL

The argument `rwattr` is invalid.

ENOSYS

The value of `pshared` is equal to `pthread_process_shared`.

f_pthread_rwlockattr_t

Purpose

This is a derived data type whose components are all private. Any object of this type should be manipulated only through the appropriate interfaces provided in this module.

Class

Data Type

f_pthread_self()

Purpose

This function can be used to return the thread ID of the calling thread.

Class

Function

Argument Type and Attributes

None

Result Type and Attributes

TYPE(f_pthread_t)

Result Value

The calling thread's ID is returned.

f_thread_setcancelstate(state, oldstate)

Purpose

This function can be used to set the thread's cancelability state. The new state will be set according to the argument **state**. The old state will be returned in the argument **oldstate**.

Class

Function

Argument Type and Attributes

state INTEGER(4), INTENT(IN)

Must contain one of the following values:

PTHREAD_CANCEL_DISABLE:

The thread's cancelability is disabled.

PTHREAD_CANCEL_ENABLE:

The thread's cancelability is enabled.

oldstate

INTEGER(4), INTENT(OUT)

On return from this function, **oldstate** will contain one of the following values:

PTHREAD_CANCEL_DISABLE:

The thread's cancelability is disabled.

PTHREAD_CANCEL_ENABLE:

The thread's cancelability is enabled.

Result Type and Attributes

INTEGER(4)

Result Value

On successful completion, this function returns 0. Otherwise, this function returns the following error.

EINVAL

The argument **state** is invalid.

f_thread_setcanceltype(type, oldtype)

Purpose

This function can be used to set the thread's cancelability type. The new type will be set according to the argument **type**. The old type will be returned in argument **oldtype**.

Class

Function

Argument Type and Attributes

type INTEGER(4), INTENT(IN)

Must contain one of the following values:

PTHREAD_CANCEL_DEFERRED:

Cancelation request will be delayed until a cancelation point.

PTHREAD_CANCEL_ASYNCCHRONOUS:

Cancelation request will be acted upon immediately. This may cause unexpected results.

oldtype

INTEGER(4), INTENT(OUT)

On return from this procedure, **oldtype** will contain one of the following values:

PTHREAD_CANCEL_DEFERRED:

Cancelation request will be delayed until a cancelation point.

PTHREAD_CANCEL_ASYNCCHRONOUS:

Cancelation request will be acted upon immediately. This may cause unexpected results.

Result Type and Attributes

INTEGER(4)

Result Value

On successful completion, this function returns 0. Otherwise, this function returns the following error.

EINVAL

The argument **type** is invalid.

f_pthread_setconcurrency(new_level)

Purpose

This function is used to inform the pthreads library implementation of the desired concurrency level as specified by the argument *new_level*. The actual level of concurrency provided by the implementation as a result of this function call is unspecified.

Class

Function

Argument Type and Attributes

new_level

INTEGER(4), INTENT(IN)

Result Type and Attributes

INTEGER(4)

Result Value

This function returns 0.

f_pthread_setschedparam(thread, policy, param)

Purpose

This function can be used to dynamically set the scheduling policy and the scheduling property of a thread. The target thread is identified by argument **thread**. The new scheduling policy for the target thread is provided through argument **policy**. The new scheduling property of the target thread will be set to the value provided by argument **param**. The sched_priority field in **param** defines the scheduling priority. Its range is 1-127.

Class

Function

Argument Type and Attributes

thread TYPE(f_pthread_t), INTENT(INOUT)

policy INTEGER(4), INTENT(IN)

param TYPE(f_sched_param), INTENT(IN)

Result Type and Attributes

INTEGER(4)

Result Value

On successful completion, this function returns 0. Otherwise, this function returns one of the following errors

ENOSYS

The POSIX priority scheduling option is not implemented on Linux.

ENOTSUP

The value of argument **policy** or **param** is not supported.

EPERM

The target thread is not permitted to perform the operation or is in a mutex protocol already.

ESRCH

The target thread does not exist or is invalid.

f_pthread_setspecific(key, arg)

Purpose

This function can be used to set the calling thread's specific data associated with the key identified by argument **key**. The argument **arg**, which is optional, identifies the thread-specific data to be set. If **arg** is not provided, the thread-specific data will be set to NULL, which is the initial value for each thread. Only an Integer pointer can be passed as the **arg** argument. If **arg** is not an Integer pointer, the result is undefined.

The actual argument **arg** must be a variable, and consequently eligible as a left-value in an assignment statement. If you pass an array section with vector subscripts to the argument **arg**, the result is unpredictable.

Class

Function

Argument Type and Attributes

key TYPE(f_thread_key_t), INTENT(IN)

arg Integer pointer, INTENT(IN), OPTIONAL

Result Type and Attributes

INTEGER(4)

Result Value

On successful completion, this function returns 0. Otherwise, this function returns one of the following errors

EINVAL

The argument **key** is invalid.

ENOMEM

There is insufficient memory to associate the data with the key.

f_thread_t

Purpose

A derived data type whose components are all private. Any object of this type should be manipulated only through the appropriate interfaces provided in this module.

This data type corresponds to the POSIX **pthread_t**, which is the type of thread object.

Class

Data Type

f_thread_testcancel()

Purpose

This subroutine provides a cancellation point in a thread. When this subroutine is called, any pending cancellation request will be acted upon immediately if the cancelability state of the thread is in the enabled state.

Class

Subroutine

Argument Type and Attributes

None

Result Type and Attributes

None

f_sched_param

Purpose

This data type corresponds to the Linux system data structure **sched_param**, which is a system data type.

This is a public data structure defined as:

```
type f_sched_param
  sequence
  integer sched_priority
end type f_sched_param
```

Class

Data Type

f_sched_yield()

Purpose

This function is used to force the calling thread to relinquish the processor until it again becomes the head of its thread list.

Class

Function

Argument Type and Attributes

None.

Result Type and Attributes

INTEGER(4)

Result Value

If this function completes successfully, value 0 is returned. Otherwise, a value of -1 will be returned.

f_timespec

Purpose

This is a Fortran definition of the Linux system data structure **timespec**. Within the Fortran Pthreads module, objects of this type are used to specify an absolute date and time. This *deadline absolute date* is used when waiting on a POSIX condition variable.

f_timespec is defined as:

```
TYPE F_Timespec
  SEQUENCE
  INTEGER(4) tv_sec
  INTEGER(4) pad
  INTEGER(KIND=REGISTER_SIZE) tv_nsec
END TYPE F_Timespec
```

Class

Data Type

Chapter 9. Interlanguage calls

Your Fortran application can perform interlanguage calls to routines written in a language other than Fortran.

The guidelines assume that you are familiar with the syntax of all applicable languages.

Conventions for XL Fortran external names

To assist you in writing mixed-language programs, XL Fortran follows a consistent set of rules when translating the name of a global entity into an external name that the linker can resolve.

The rules are:

- Both the underscore (`_`) and the dollar sign (`$`) are valid characters anywhere in names.

Because names that begin with an underscore are reserved for the names of library routines, do not use an underscore as the first character of a Fortran external name.

To avoid conflicts between Fortran and non-Fortran function names, you can compile the Fortran program with the `-qextname` option. This option adds an underscore to the end of the Fortran names. Then use an underscore as the last character of any non-Fortran procedures that you want to call from Fortran.

- Names can be up to 250 characters long.
- Program and symbolic names are interpreted as all lowercase by default. If you are writing new non-Fortran code, use all-lowercase procedure names to simplify calling the procedures from Fortran.

You can use the `-U` option or the `@PROCESS MIXED` directive if you want the names to use both uppercase and lowercase:

```
@process mixed
  external C_Func      ! With MIXED, we can call C_Func, not just c_func.
  integer aBC, ABC    ! With MIXED, these are different variables.
  common /xYz/ aBc    ! The same applies to the common block names.
  common /XYZ/ ABC    ! xYz and XYZ are external names that are
                    ! visible during linking.
end
```

- Names for module procedures are formed by concatenating `__` (two underscores), the module name, `_IMOD_` (for intrinsic modules) or `_NMOD_` (for non-intrinsic modules), and the name of the module procedure. For example, module procedure `MYPROC` in module `MYMOD` has the external name `__mymod_NMOD_myproc`.

Note: Symbolic debuggers and other tools should account for this naming scheme when debugging XL Fortran programs that contain module procedures. For example, some debuggers default to lowercase for program and symbolic names. This behavior should be changed to use mixed case when debugging XL Fortran programs with module procedures.

- The XL compilers generate code that uses `main` as an external entry point name. You can only use `main` as an external name in these contexts:

- A Fortran program or local-variable name. (This restriction means that you cannot use `main` as a binding label, or for the name of an external function, external subroutine, block data program unit, or common block. References to such an object use the compiler-generated `main` instead of your own.)
- The name of the top-level main function in a C program.
- Some other potential naming conflicts may occur when linking a program. For instructions on avoiding them, see *Avoiding naming conflicts during linking in the XL Fortran Compiler Reference*.

If you are porting your application from another system and your application does encounter naming conflicts like these, you may need to use the `-qextname` option.

Mixed-language input and output

To improve performance, the XL Fortran runtime library has its own buffers and its own handling of these buffers. This means that mixed-language programs cannot freely mix I/O operations on the same file from the different languages.

Mixing code compiled by multiple Fortran compilers, for example `xlf` and `gfortran`, could face similar problems. The safest approach is to treat the code compiled by another Fortran compiler as non-Fortran code. To maintain data integrity in such cases:

- If the file position is not important, open and explicitly close the file within the Fortran part of the program before performing any I/O operations on that file from subprograms written in another language.
- To open a file in Fortran and manipulate the open file from another language, call the `flush_` procedure to save any buffer for that file, and then use the `getfd` procedure to find the corresponding file descriptor and pass it to the non-Fortran subprogram.

As an alternative to calling the `flush_` procedure, you can use the `buffering` runtime option to disable the buffering for I/O operations. When you specify `buffering=disable_preconn`, XL Fortran disables the buffering for preconnected units. When you specify `buffering=disable_all`, XL Fortran disables the buffering for all logical units.

Note: After you call `flush_` to flush the buffer for a file, do not do anything to the file from the Fortran part of the program except to close it when the non-Fortran processing is finished.

- If any XL Fortran subprograms containing `WRITE` statements are called from a non-Fortran main program, explicitly `CLOSE` the data file, or use the `flush_` subroutine in the XL Fortran subprograms to ensure that the buffers are flushed. Alternatively, you can use the `buffering` runtime option to disable buffering for I/O operations.

For more information on the `flush_` and `getfd` procedures, see the *Service and utility procedures* topic in the *XL Fortran Language Reference*. For more information on the `buffering` runtime option, see *Setting runtime options* in the *XL Fortran Compiler Reference*.

Mixing Fortran and C++

When mixing Fortran and C++ in the same program, you need to invoke the C++ compiler to correctly link the final program.

Most of the information in this section applies to Fortran and languages with similar data types and naming schemes. However, to mix Fortran and C++ in the same program, you must add an extra level of indirection and pass the interlanguage calls through C++ wrapper functions.

Because the C++ compiler mangles the names of some C++ objects, you must use your C++ compiler's invocation command, like `xlC` or `g++`, to link the final program and include `-L` and `-I` options for the XL Fortran library directories and libraries.

```

program main

integer idim, idim1

idim = 35
idim1 = 45

write(6,*) 'Inside Fortran calling first C function'
call cfun(idim)
write(6,*) 'Inside Fortran calling second C function'
call cfun1(idim1)
write(6,*) 'Exiting the Fortran program'
end

```

Figure 4. Main Fortran program that calls C++ (main1.f)

```

#include <stdio.h>
#include "cplus.h"

extern "C" void cfun(int *idim){
    printf("%sInside C function before creating C++ Object\n");
    int i = *idim;
    junk<int>* jj= new junk<int>(10,30);
    jj->store(idim);
    jj->print();
    printf("%sInside C function after creating C++ Object\n");
    delete jj;
    return;
}

extern "C" void cfun1(int *idim1) {
    printf("%sInside C function cfun1 before creating C++ Object\n");
    int i = *idim1;
    temp<double> *tmp = new temp<double>(40, 50.54);
    tmp->print();
    printf("%sInside C function after creating C++ temp object\n");
    delete tmp;
    return;
}

```

Figure 5. C++ wrapper functions for calling C++ (cfun.C)

```

#include <iostream.h>

template<class T> class junk {

private:
    int inter;
    T   templ_mem;
    T   stor_val;

public:
    junk(int i,T j): inter(i),templ_mem(j)
                    {cout <<"***Inside C++ constructor" << endl;}

    ~junk()          {cout <<"***Inside C++ Destructor" << endl;}

    void store(T *val){ stor_val = *val;}

    void print(void) {cout << inter << "\t" << templ_mem ;
                    cout << "\t" << stor_val << endl; }};

template<class T> class temp {

private:
    int internal;
    T   temp_var;

public:
    temp(int i, T j): internal(i),temp_var(j)
                    {cout <<"***Inside C++ temp Constructor" <<endl;}

    ~temp()          {cout <<"***Inside C++ temp destructor" <<endl;}

    void print(void) {cout << internal << "\t" << temp_var << endl;}};

```

Figure 6. C++ code called from Fortran (*cplus.h*)

Compiling this program, linking it with the `xlc` command, and running it produces the following output:

```

    Inside Fortran calling first C function
%Inside C function before creating C++ Object
***Inside C++ constructor
10    30    35
%Inside C function after creating C++ Object
***Inside C++ Destructor
    Inside Fortran calling second C function
%Inside C function cfun1 before creating C++ Object
***Inside C++ temp Constructor
40    50.54
%Inside C function after creating C++ temp object
***Inside C++ temp destructor
    Exiting the Fortran program

```

Making calls to C functions work

When you pass an argument to a subprogram call, the usual Fortran convention is to pass the address of the argument. Many C functions expect arguments to be passed as values, however, not as addresses.

For these arguments, specify them as `%VAL(argument)` in the call to C, or make use of the standards-compliant `VALUE` attribute. For example:

```

MEMBLK = MALLOC(1024)    ! Wrong, passes the address of the constant
MEMBLK = MALLOC(N)      ! Wrong, passes the address of the variable

MEMBLK = MALLOC(%VAL(1024)) ! Right, passes the value 1024
MEMBLK = MALLOC(%VAL(N))   ! Right, passes the value of the variable

```

See “Passing arguments by reference or by value” on page 267 and %VAL and %REF in the *XL Fortran Language Reference* for more details.

Passing data from one language to another

You need to account for corresponding data types in Fortran and C when passing data from one language to another.

The Corresponding data types in Fortran and C table shows the data types available in the XL Fortran and C languages. Further topics detail how Fortran arguments can be passed by reference to C programs. To use the Fortran Standard interoperability features, see the BIND attribute and ISO_C_BINDING module in the *XL Fortran Language Reference*.

Passing arguments between languages

When calling Fortran procedures, the C routines must pass arguments as pointers to the types listed in the following table.

Table 24. Corresponding data types in Fortran and C

XL Fortran Data Types	XL C/C++ Data Types
INTEGER(1), BYTE	signed char
INTEGER(2)	signed short
INTEGER(4)	signed int
INTEGER(8)	signed long long
REAL, REAL(4)	float
REAL(8), DOUBLE PRECISION	double
REAL(16)	long double
COMPLEX, COMPLEX(4)	float _Complex
COMPLEX(8), DOUBLE COMPLEX	double _Complex
COMPLEX(16)	long double _Complex
LOGICAL(1)	unsigned char
LOGICAL(2)	unsigned short
LOGICAL(4)	unsigned int
LOGICAL(8)	unsigned long long
CHARACTER	char
CHARACTER(n)	char[n]
Integer POINTER	void *
Array	array
Sequence-derived type	structure (with C/C++ -qalign=packed option)

Notes:

1. In interlanguage communication, it is often necessary to use the `%VAL` built-in function, or the standards-compliant `VALUE` attribute, and the `%REF` built-in function that are defined in “Passing arguments by reference or by value” on page 267.
2. C programs automatically convert float values to double and short integer values to integer when calling an unprototyped C function. Because XL Fortran does not perform a conversion on `REAL(4)` quantities passed by value, you should not pass `REAL(4)` and `INTEGER(2)` by value to a C function that you have not declared with an explicit interface.
3. The Fortran-derived type and the C structure must match in the number, data type, and length of subobjects to be compatible data types.

One or more sample programs under the directory `/opt/ibm/xlf/15.1.0/samples` illustrate how to call from Fortran to C.

To use the Fortran Standard interoperability features provided by XL Fortran, see the Language interoperability features section in the *XL Fortran Language Reference*.

Passing global variables between languages

To access a C data structure from within a Fortran program or to access a common block from within a C program, follow these steps:

1. Create a named common block that provides a one-to-one mapping of the C structure members. If you have an unnamed common block, change it to a named one. Name the common block with the name of the C structure.
2. Declare the C structure as a global variable by putting its declaration outside any function or inside a function with the `extern` qualifier.
3. Compile the C source file to get packed structures.

```

program cstruct
real(8) a,d
integer b,c
.
.
common /mystuff/ a,b,c,d
.
end

struct mystuff {
double a;
int b,c;
double d;
};

main() {

```

If you do not have a specific need for a named common block, you can create a sequence-derived type with the same one-to-one mapping as a C structure and pass it as an argument to a C function. You must compile the C source file to get packed structures or put `#pragmas` into the struct.

Common blocks that are declared `THREADLOCAL` are thread-specific data areas that are dynamically allocated by compiler-generated code. A static block is still reserved for a `THREADLOCAL` common block, but the compiler and the compiler's runtime environment use it for control information. If you need to share `THREADLOCAL` common blocks between Fortran and C procedures, your C source must be aware of the implementation of the `THREADLOCAL` common block. For more information, see the *Directives* section in the *XL Fortran Language Reference*, and Chapter 14, “Sample Fortran programs,” on page 321.

Common blocks that are declared `THREADPRIVATE` can be accessed using a C global variable that is declared as `THREADPRIVATE`.

Passing character types between languages

One difficult aspect of interlanguage calls is passing character strings between languages. The difficulty is due to the following underlying differences in the way that different languages represent such entities:

- The only character type in Fortran is **CHARACTER**, which is stored as a set of contiguous bytes, one character per byte. The length is not stored as part of the entity. Instead, it is passed by value as an extra argument at the end of the declared argument list when the entity is passed as an argument. The size of the argument is 8 bytes.
- Character strings in C are stored as arrays of the type **char**. A null character indicates the end of the string.

Note: To have the compiler automatically add the null character to certain character arguments, you can use the **-qnullterm** option (described in the *XL Fortran Compiler Reference*).

If you are writing both parts of the mixed-language program, you can make the C routines deal with the extra Fortran length argument, or you can suppress this extra argument by passing the string using the **%REF** function. If you use **%REF**, which you typically would for pre-existing C routines, you need to indicate where the string ends by concatenating a null character to the end of each character string that is passed to a C routine:

```
! Initialize a character string to pass to C.
      character*6 message1 /'Hello\0'/
! Initialize a character string as usual, and append the null later.
      character*5 message2 /'world'/

! Pass both strings to a C function that takes 2 (char *) arguments.
      call cfunc(%ref(message1), %ref(message2 // '\0'))
      end
```

For compatibility with C language usage, you can encode the following escape sequences in XL Fortran character strings:

Table 25. Escape sequences for character strings

Escape	Meaning
\b	Backspace
\f	Form feed
\n	New-line
\r	Carriage return
\t	Tab
\0	Null
\'	Apostrophe (does not terminate a string)
\"	Double quotation mark (does not terminate a string)
\\	Backslash
\x	<i>x</i> , where <i>x</i> is any other character (the backslash is ignored)

If you do not want the backslash interpreted as an escape character within strings, you can compile with the **-qnoescape** option.

Passing arrays between languages

Fortran stores array elements in ascending storage units in column-major order. C stores array elements in row-major order. Fortran array indexes start at 1, while C array indexes start at 0.

The following example shows how a two-dimensional array that is declared by A(3,2) is stored in Fortran and C.

Table 26. Corresponding array layouts for Fortran and C. The Fortran array reference A(X,Y,Z) can be expressed in C as a[Z-1][Y-1][X-1]. Keep in mind that although C passes individual scalar array elements by value, it passes arrays by reference.

	Fortran Element Name	C Element Name
Lowest storage unit	A(1,1)	A[0][0]
	A(2,1)	A[0][1]
	A(3,1)	A[1][0]
	A(1,2)	A[1][1]
	A(2,2)	A[2][0]
Highest storage unit	A(3,2)	A[2][1]

To pass all or part of a Fortran array to another language, you can use Fortran 90/Fortran 95 array notation:

```
REAL, DIMENSION(4,8) :: A, B(10)
```

```
! Pass an entire 4 x 8 array.
CALL CFUNC( A )
! Pass only the upper-left quadrant of the array.
CALL CFUNC( A(1:2,1:4) )
! Pass an array consisting of every third element of A.
CALL CFUNC( A(1:4:3,1:8) )
! Pass a 1-dimensional array consisting of elements 1, 2, and 4 of B.
CALL CFUNC( B( (/1,2,4/) ) )
```

Where necessary, the Fortran program constructs a temporary array and copies all the elements into contiguous storage. In all cases, the C routine needs to account for the column-major layout of the array.

Any array section or noncontiguous array is passed as the address of a contiguous temporary unless an explicit interface exists where the corresponding dummy argument is declared as an assumed-shape array or a pointer. To avoid the creation of array descriptors (which are not supported for interlanguage calls) when calling non-Fortran procedures with array arguments, either do not give the non-Fortran procedures any explicit interface, or do not declare the corresponding dummy arguments as assumed-shape or pointers in the interface:

```
! This explicit interface must be changed before the C function
! can be called.
INTERFACE
  FUNCTION CFUNC (ARRAY, PTR1, PTR2)
    INTEGER, DIMENSION (:) :: ARRAY      ! Change this : to *.
    INTEGER, POINTER, DIMENSION (:) :: PTR1 ! Change this : to *
                                           ! and remove the POINTER
                                           ! attribute.
    REAL, POINTER :: PTR2                ! Remove this POINTER
                                           ! attribute or change to TARGET.
  END FUNCTION
END INTERFACE
```

Passing pointers between languages

Integer **POINTERS** always represent the address of the pointee object and must be passed by value:

```
CALL CFUNC(%VAL(INTPTR))
```

Fortran 90 **POINTERS** can also be passed back and forth between languages but only if there is no explicit interface for the called procedure or if the argument in the explicit interface does not have a **POINTER** attribute or assumed-shape declarator. You can remove any **POINTER** attribute or change it to **TARGET** and can change any deferred-shape array declarator to be explicit-shape or assumed-size.

Because of XL Fortran's call-by-reference conventions, you must pass even scalar values from another language as the address of the value, rather than the value itself. For example, a C function passing an integer value *x* to Fortran must pass `&x`. Also, a C function passing a pointer value *p* to Fortran so that Fortran can use it as an integer **POINTER** must declare it as `void **p`. A C array is an exception: you can pass it to Fortran without the `&` operator.

Passing arguments by reference or by value

To call subprograms written in languages other than Fortran (for example, user-written C programs, or operating system routines), the actual arguments may need to be passed by a method different from the default method used by Fortran. C routines, including those in system libraries, such as `libc.so`, require you to pass arguments by value instead of by reference. (Although C passes individual scalar array elements by value, it passes arrays by reference.)

You can change the default passing method by using the **%VAL** built-in function or **VALUE** attribute and the **%REF** built-in function in the argument list of a **CALL** statement or function reference. You cannot use them in the argument lists of Fortran procedure references or with alternate return specifiers.

%REF Passes an argument by reference (that is, the called subprogram receives the address of the argument). It is the same as the default calling method for Fortran except that it also suppresses the extra length argument for character strings.

%VAL Passes an argument by value (that is, the called subprogram receives an argument that has the same value as the actual argument, but any change to this argument does not affect the actual argument).

You can use this built-in function with actual arguments that are **CHARACTER(1)**, **BYTE**, logical, integer, real, or complex expressions or that are sequence-derived type. Objects of derived type cannot contain pointers, arrays, or character structure components whose lengths are greater than one byte.

You cannot use **%VAL** with actual arguments that are array entities, procedure names, or character expressions of length greater than one byte.

%VAL causes XL Fortran to pass the actual argument as 32-bit or 64-bit intermediate values.

32-bit intermediate values

If the actual argument is one of the following:

- An integer or a logical that is shorter than 32 bits, it is sign-extended to a 32-bit value.

- An integer or a logical that is longer than 32 bits, it is passed as two 32-bit intermediate values.
- Of type real or complex, it is passed as multiple 32-bit intermediate values.
- Of sequence-derived type, it is passed as multiple 32-bit intermediate values.

Byte-named constants and variables are passed as if they were **INTEGER(1)**. If the actual argument is a **CHARACTER(1)**, the compiler pads it on the left with zeros to a 32-bit value, regardless of whether you specified the **-qctyplss** compiler option.

64-bit intermediate values

If the actual argument is one of the following:

- An integer or a logical that is shorter than 64 bits, it is sign-extended to a 64-bit value.
- Of type real or complex, it is passed as multiple 64-bit intermediate values.
- Of sequence-derived type, it is passed as multiple 64-bit intermediate values.

Byte-named constants and variables are passed as if they were **INTEGER(1)**. If the actual argument is a **CHARACTER(1)**, the compiler pads it on the left with zeros to a 64-bit value, regardless of whether you specified the **-qctyplss** compiler option.

VALUE attribute

Specifies an argument association between a dummy and an actual argument that allows you to pass the dummy argument with the value of the actual argument. Changes to the value or definition status of the dummy argument do not affect the actual argument.

You must specify the **VALUE** attribute for dummy arguments only.

You must not use the **%VAL** or **%REF** built-in functions to reference a dummy argument with the **VALUE** attribute, or the associated actual argument.

A referenced procedure that has a dummy argument with the **VALUE** attribute must have an explicit interface.

You must not specify the **VALUE** attribute with the following:

- Arrays
- Derived types with **ALLOCATABLE** components
- Dummy procedures

```
EXTERNAL FUNC
COMPLEX XVAR
IVARB=6
```

```
CALL RIGHT2(%REF(FUNC))      ! procedure name passed by reference
CALL RIGHT3(%VAL(XVAR))     ! complex argument passed by value
CALL TPROG(%VAL(IVARB))     ! integer argument passed by value
END
```

Explicit interface for %VAL and %REF

You can specify an explicit interface for non-Fortran procedures to avoid coding calls to **%VAL** and **%REF** in each argument list, as follows:

```

INTERFACE
  FUNCTION C_FUNC(%VAL(A),%VAL(B)) ! Now you can code "c_func(a,b)"
    INTEGER A,B                    ! instead of
  END FUNCTION C_FUNC              ! "c_func(%val(a),%val(b))".
END INTERFACE

```

Example with VALUE attribute

```

Program validexm1
  integer :: x = 10, y = 20
  print *, 'before calling: ', x, y
  call intersub(x, y)
  print *, 'after calling: ', x, y

  contains
  subroutine intersub(x,y)
    integer, value :: x
    integer y
    x = x + y
    y = x*y
    print *, 'in subroutine after changing: ', x, y
  end subroutine
end program validexm1

```

Expected output:

```

before calling: 10 20
in subroutine after changing: 30 600
after calling: 10 600

```

Passing COMPLEX values to/from gcc

Passing COMPLEX values between Fortran and GCC depends on what is specified for the `-qfloat=[no]complexgcc` suboption. If `-qfloat=complexgcc` is specified, the compiler uses Linux conventions when passing or returning complex numbers. `-qfloat=nocomplexgcc` is the default.

For `-qfloat=complexgcc`, COMPLEX*8 values are passed in 1 GPR, and COMPLEX*16 in 2 GPRs. For `-qfloat=nocomplexgcc`, COMPLEX*8 and COMPLEX*16 values are passed in 2 floating-point registers (FPRs). COMPLEX*32 values are always passed in 4 FPRs for both `-qfloat=complexgcc` and `-qfloat=nocomplexgcc` (since gcc does not support COMPLEX*32).

For `-qfloat=complexgcc`, COMPLEX*8 values are returned in GPR3, and COMPLEX*16 in GPR 3-GPR4. For `-qfloat=nocomplexgcc`, COMPLEX*8 and COMPLEX*16 values are returned in FPR1-FPR2. For both `-qfloat=complexgcc` and `-qfloat=nocomplexgcc`, COMPLEX*32 is always returned in FPR1-FPR4.

Returning values from Fortran functions

XL Fortran does not support calling certain types of Fortran functions from non-Fortran procedures. If a Fortran function returns a pointer, array, or character of nonconstant length, do not call it from outside Fortran.

You can call such a function indirectly:

```

SUBROUTINE MAT2(A,B,C) ! You can call this subroutine from C, and the
                      ! result is stored in C.
INTEGER, DIMENSION(10,10) :: A,B,C
C = ARRAY_FUNC(A,B) ! But you could not call ARRAY_FUNC directly.
END

```

Arguments with the OPTIONAL attribute

When you pass an optional argument by reference, the address in the argument list is zero if the argument is not present.

When you pass an optional argument by value, the value is zero if the argument is not present. The compiler uses an extra register argument to differentiate that value from a regular zero value. If the register has the value 1, the optional argument is present; if it has the value 0, the optional argument is not present.

Related information:

“Order of arguments in argument list” on page 276

Assembler-level subroutine linkage conventions

The subroutine linkage convention specifies the machine state at subroutine entry and exit, allowing routines that are compiled separately in the same or different languages to be linked.

The information on subroutine linkage and system calls in the *System V Application Binary Interface: PowerPC Processor Supplement* and *64-bit PowerPC ELF Application Binary Interface Supplement* are the base references on this topic. You should consult these for full details. This section summarizes the information needed to write mixed-language Fortran and assembler programs or to debug at the assembler level, where you need to be concerned with these kinds of low-level details.

The system linkage convention passes arguments in registers, taking full advantage of the large number of floating-point registers (FPRs), general-purpose registers (GPRs), vector registers (VRs and VSRs) and minimizing the saving and restoring of registers on subroutine entry and exit. The linkage convention allows for argument passing and return values to be in registers (FPRs, GPRs, VRs or multiple register types), memory, or both.

The following table lists floating-point registers and their functions. The floating-point registers are double precision (64 bits).

Table 27. Floating-point register usage across calls

Register	Preserved Across Calls	Use
0	no	
1	no	FP parameter 1, function return 1.
2	no	FP parameter 2, function return 2.
3	no	FP parameter 3, function return 3, function return complex *32.
4	no	FP parameter 4, function return 4 , function return complex *32.
5	no	FP parameter 5, function return 5.
:	:	:
:	:	:
8	no	FP parameter 8, function return 8.
9	no	FP parameter 9
10	no	FP parameter 10
11	no	FP parameter 11

Table 27. Floating-point register usage across calls (continued)

Register	Preserved Across Calls	Use
12	no	FP parameter 12
13	no	FP parameter 13
14-31	yes	local variables

The following table lists general-purpose registers and their functions.

Table 28. General-purpose register usage across calls

Register	Preserved Across Calls	Use
0	no	
1	yes	Stack pointer.
2	yes	System-reserved TOC/GOT pointer.
3	no	1st word of arg list; return value 1.
4	no	2nd word of arg list; return value 2.
5	no	3rd word of arg list
⋮	⋮	⋮
10	no	8th word of arg list.
11-12	no	
13	yes	SDA (thread local storage) pointer.
14-30	no	Local variables.
31	yes	Local variables or “environment pointers”.
<p>If a register is not designated as preserved, its contents may be changed during the call, and the caller is responsible for saving any registers whose values are needed later. Conversely, if a register is supposed to be preserved, the callee is responsible for preserving its contents across the call, and the caller does not need any special action.</p>		

The following table lists vector register conventions.

Table 29. VMX Vector register usage across calls

Register	Preserved Across Calls	Use
0	no	Local variables
1	no	Local variables
2	no	Vector parameter 1, vector result 1
3	no	Vector parameter 2, vector result 2
4	no	Vector parameter 3, vector result 3
5	no	Vector parameter 4, vector result 4
6	no	Vector parameter 5, vector result 5
7	no	Vector parameter 6, vector result 6

Table 29. VMX Vector register usage across calls (continued)

Register	Preserved Across Calls	Use
8	no	Vector parameter 7, vector result 7
9	no	Vector parameter 8, vector result 8
10	no	Vector parameter 9
11	no	Vector parameter 10
12	no	Vector parameter 11
13	no	Vector parameter 12
14-19	no	Local variables
20-31	yes	Local variables
VMX vector registers VR0-31 correspond to VSX registers 32-63. FPR floating-point registers FP0-31 correspond to the upper halves of VSX registers 0-31.		

The following table lists special-purpose register conventions.

Table 30. Special-purpose register usage across calls

Register	Preserved Across Calls
Condition register Bits 0-7 (CR0,CR1) Bits 8-22 (CR2,CR3,CR4) Bits 23-31 (CR5,CR6,CR7)	no yes no
Link register	no
Count register	no
XER register	no
FPSCR register	The control flags are preserved except for calls to functions whose purposes are to change them. The status flags are not preserved.

The stack

The stack is a portion of storage that is used to hold local storage, register save areas, parameter lists, and call-chain data. The stack grows from higher addresses to lower addresses. A stack pointer register (register 1) is used to mark the current “top” of the stack.

A stack frame is the portion of the stack that is used by a single procedure. In either case, the stack frame size is best defined as the difference between the caller's stack pointer and the callee's.

The following diagram shows the storage maps of typical stack frames.

In this diagram, the current routine has acquired a stack frame that allows it to call other functions. If the routine does not make any calls and there are no local variables or temporaries, and it does not need to save any nonvolatile registers, the function need not allocate a stack frame. It can use the register save area at the top of where the callee's stack frame would have been, if needed.

The stack frame is quadword aligned.

The following diagram shows the storage map of a typical stack frame.

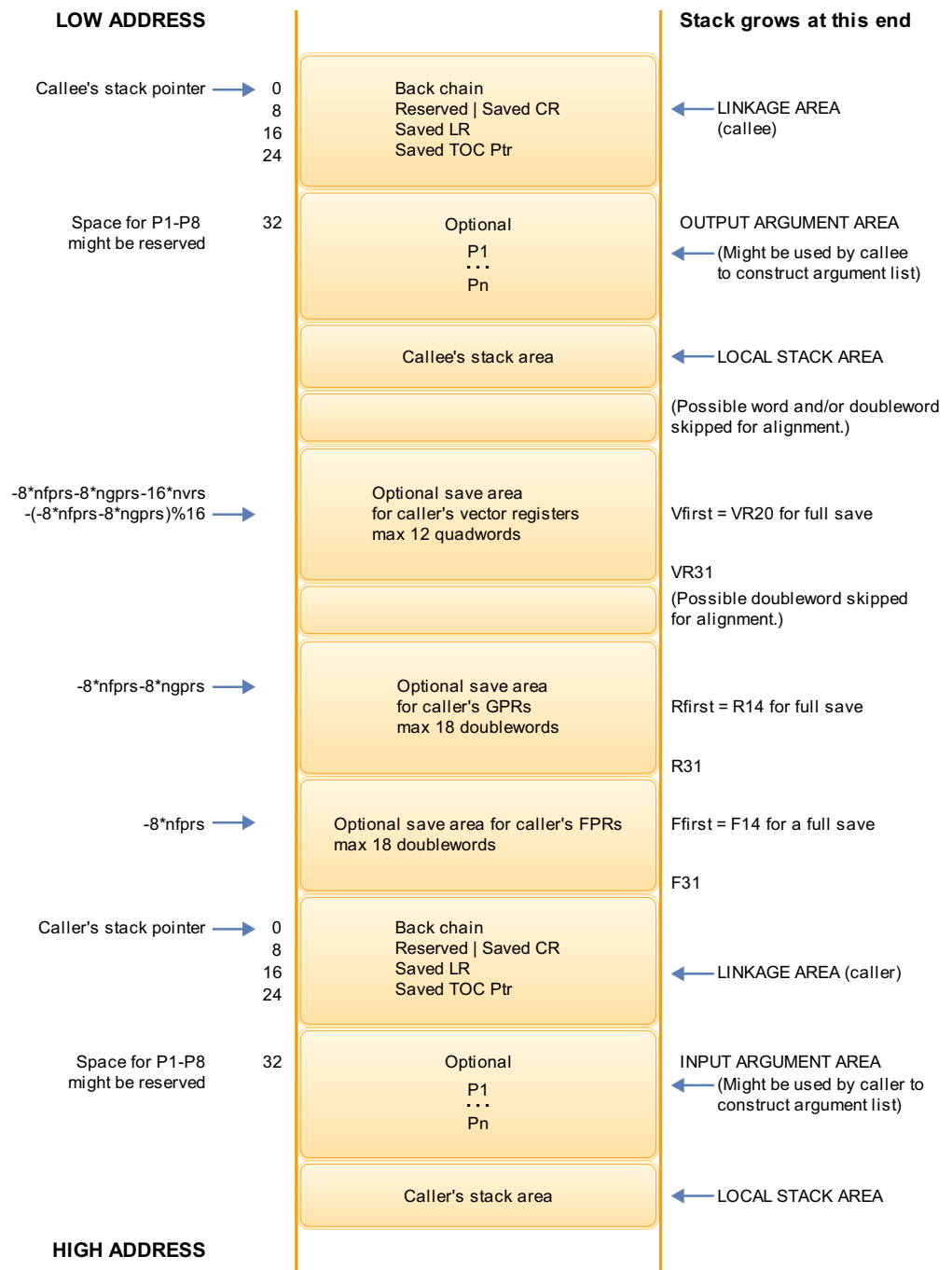

Figure 7. Runtime Stack

The Linkage Area and Minimum Stack Frame

The linkage area consists of four doublewords at offset zero from the caller's stack pointer on entry to a procedure. The first doubleword contains the caller's back chain (stack pointer). The first half of the second doubleword is the location where the callee saves the Condition Register (CR) if it is needed. The third doubleword is the location where the callee's prolog code saves the Link Register if it is needed.

The last doubleword (doubleword 4) is where the caller's TOC pointer is saved when the routine is called via its Global Entry Point (for example, when it is in a shared library, or called via a pointer). The minimum stack frame size is 32 bytes..

The input parameter area

The input parameter area is a contiguous piece of storage reserved by the calling program under specific conditions (when an overflow area is needed, or when the callee is declared as a varargs function) to represent the register image of the input parameters of the callee. The input parameter area is quadword aligned and is located on the stack directly following the caller's link area. If it is allocated, this area is at least 8 doublewords in size. If more than 8 doublewords of parameters are passed, they are stored as register images that start at positive offset 96 from the caller's stack pointer.

The first 8 doublewords only appear in registers at the call point, never in the stack. Remaining words are always in the stack.

The register save area

Register save area is doubleword aligned for GPRs and FPRs and quadword aligned for VRs. It provides the space that is needed to save all nonvolatile FPRs, GPRs and VRs used by the callee program. The FPRs are saved next to the link area. The FPRs are saved at the highest addresses of the stack frame. The GPRs are saved just below (in lower addresses than) the FPRs. The VRs are saved just below (in lower addresses than) the GPRs. The called function may save the registers here even if it does not need to allocate a new stack frame. The system-defined stack floor includes the maximum possible save area:

18×8 for FPRs + 18×8 for GPRs + 12×16 for VRs

For each register type, a callee needs only to save the nonvolatile registers starting with the lowest that it actually uses, up to the highest register number; for example, using r27 and r31 means that r27 to r31 must be saved.

The local stack area

The local stack area is the space that is allocated by the callee procedure for local variables and temporaries.

The output parameter area

The output parameter area (P1...Pn) is optional. It must be allocated when calling a varargs function or when more than 8 doublewords of parameters are being passed. If more than 8 doublewords are being passed, an extension list is constructed, which begins at offset 96 from the current stack pointer.

The first 8 doublewords only appear in registers at the call point, never in the stack. Remaining doublewords are always in the stack, and they can also be in registers.

Linkage convention for argument passing

The system linkage convention takes advantage of the large number of registers available.

The linkage convention passes arguments in GPRs, FPRs and VRs. Three fixed lists, R3-R10, FP1-FP13 and VR2-VR13, specify the GPRs, FPRs and VRs available.

When there are more argument words than available argument GPRs, FPRs and VRs, the remaining words are passed in storage on the stack. The values in storage are the same values as if they were in registers but are in memory format while values in registers might be in a different format. Here are some examples. A single precision floating-point is in double precision format when in an FPR but in single precision format when in memory or passed in a GPR. A small struct may be right justified when in a GPR but left justified in memory. A vector may have its element order reversed when in a VR.

When it must be allocated, the size of the parameter area is sufficient to contain all the arguments passed on any call statement from the procedure that is associated with the stack frame. Although not all the arguments for a particular call actually appear in storage, it is convenient to consider them as forming a list in this area, each one occupying one or more doublewords.

For call by reference (as is the default for Fortran), the address of the argument is passed in a register. The following information refers to call by value, as in C or as in Fortran when %VAL is used. For purposes of their appearance in the list, arguments are classified as floating-point values including homogeneous floating-point aggregates of up to 8 single precision REAL(4)s, 4 single precision COMPLEX(8)s, 4 double precision REAL(8)s and 2 double precision COMPLEX(16)s, vector values including homogeneous vector aggregates of up to 8 vectors and other types that are passed in vector registers, or general values.

- All general values require one doubleword that is doubleword aligned.
- Each single-precision (**REAL(4)**) value and each double-precision (**REAL(8)**) value occupies one doubleword in the list. Each extended-precision (**REAL(16)**) value occupies two successive doublewords in the list.
- A **COMPLEX** value occupies twice as many doublewords as a **REAL** value with the same kind type parameter.
- A **VECTOR** value occupies four words (16 bytes) in a vector register
- In Fortran and C, structure values appear in successive words as they would anywhere in storage, satisfying all appropriate alignment requirements. Structures are aligned to a doubleword and occupy $(\text{sizeof}(\text{struct } X)+7)/8$ doublewords, with any padding at the end. A structure that is smaller than a doubleword is right-justified within its doubleword or register. Larger structures can occupy multiple registers and may be passed partly in storage and partly in registers.
- Other aggregate values are passed “val-by-ref”. That is, the compiler actually passes their address and arranges for a copy to be made in the invoked program.
- A procedure or function pointer is passed as the address of its Global Entry Point, or in some cases as the address of its Procedure Linkage Table (PLT) stub, which is automatically generated by the linker, or a dynamic library loader or trampoline code for a nested routine. See “Pointers to functions” on page 277 for more information.

Argument passing rules (by value)

From the following illustration, we state these rules:

- If the called procedure treats the parameter list as a contiguous piece of storage (for example, if the address of a parameter is taken in C), the parameter registers are stored in the space reserved for them in the stack.
- A register image is stored on the stack, except as described in section “Linkage convention for argument passing” on page 274.

- If it exists, the argument area ($P_1 \dots P_n$) must be large enough to hold the largest parameter list. Unless the overflow parameter area is needed or the called function is declared `varargs`, the argument area will not be allocated, and the callee must allocate its own area or individual variables.

Here is an example of a call to a function :

```
f(%val(11), %val(12), %val(13), %val(14), %val(15), %val(16), %val(17),
  %val(d1), %val(f1), %val(c1), %val(d2), %val(s1), %val(cx2))
```

where:

- l denotes integer(4) (fullword integer)
- d denotes real(8) (double precision)
- f denotes real(4) (real)
- s denotes integer(2) (halfword integer)
- c denotes character (one character)
- cx denotes complex(8) (double complex)

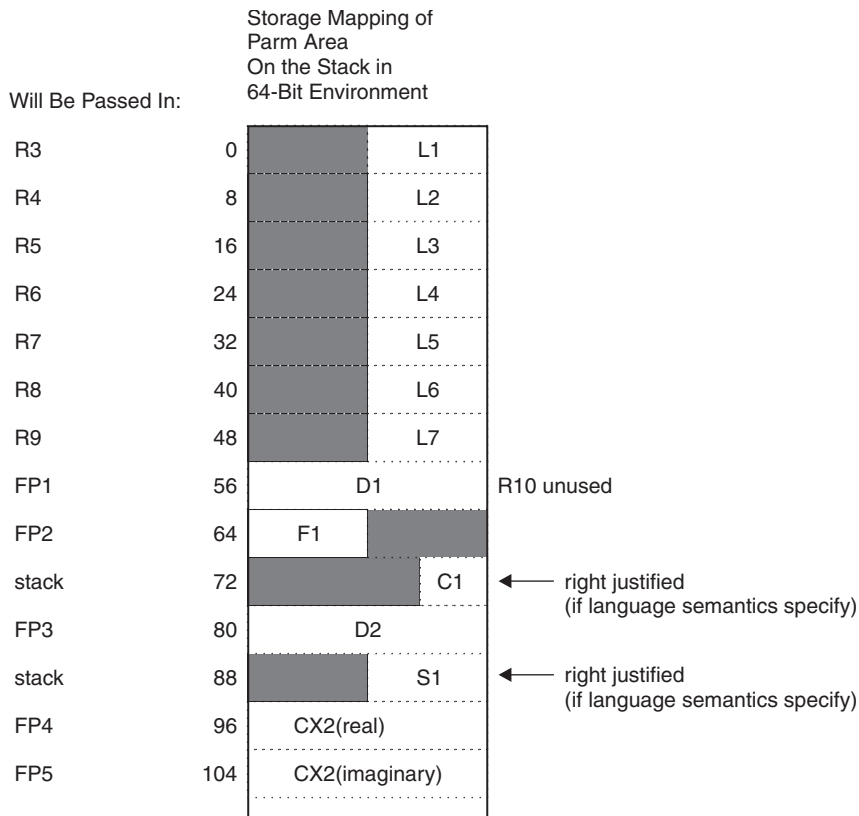

Figure 8. Storage mapping of parm area on the stack

Order of arguments in argument list

The argument list is constructed in the following order. Items in the same bullet appear in the same order as in the procedure declaration, whether or not argument keywords are used in the call.

1. There may be other items in this list during Fortran-Fortran calls. However, they will not be visible to non-Fortran procedures that follow the calling rules in this section.

- All addresses or values (or both) of actual arguments ¹
- “Present” indicators for optional arguments
- Length arguments for strings ¹

Linkage convention for function calls

Function calls to a routine make use of its entry point symbols.

A routine has two symbols associated with it: a Global Entry Point (*name*) and a Local Entry Point (*name* plus a small offset provided in its symbol table entry). Calls that might need a new TOC pointer loaded use the GEP, and examples are calls crossing shared library boundaries and calls via a pointer. Calls that share the same TOC use the LEP, and examples are calls to a nested routine or to a statically linked routine. When a call is made to a routine, the program branches to the entry point directly. Excluding the loading of parameters (if any) in the proper registers, compilers expand calls to functions to one or in general both of the following two-instruction sequence. The special NOP is needed only if the called routine might need a new TOC pointer loaded.

```
BL    .foo                # Branch to foo
ORI  R0,R0,0x0000        # Special NOP
```

The linker does one of two things when it encounters a **BL** instruction:

1. If `foo` is imported (not in the same object module), the linker changes the **BL** to `.foo` to a **BL** to the Procedure Linkage Table (PLT) stub for `foo` and inserts the PLT stub into the object module. Also, if a **NOP** instruction (`ORI R0,R0,0x0000`) immediately follows the **BL** instruction, the linker replaces the **NOP** instruction with the **LOAD** instruction `L R2, 24(R1)`.
2. If `foo` is bound in the same object module as its caller and a **LOAD** instruction above, or `ORI R0,R0,0` immediately follows the **BL** instruction, the linker replaces the **LOAD** instruction with a **NOP** (`ORI R0,R0,0`).

Calls to nested routines are more complicated. Nested routines can only be accessed from outside their parent via a pointer, which will contain the address of a trampoline routine to provide an environment pointer for them to access their parent's data, automatically generated by the compiler. Because trampolines require an executable stack, pointers to nested routines should generally not be used in programs with root security access.

Pointers to functions

A function pointer is a data type whose values range over procedure names. Variables of this type appear in several programming languages, such as C and Fortran. In Fortran, a dummy argument that appears in an **EXTERNAL** statement is a function pointer. Fortran provides support for the use of function pointers in contexts such as the target of a call statement or an actual argument of such a statement.

A function pointer is a doubleword quantity that is the address of the Global Entry Point for a function, or of a Procedure Linkage Table stub for a function, or of a trampoline for a nested function.

Function pointers are 8 bytes long and contain a 64-bit address. For pointers to local functions, the address contained is the Global Entry Point address of the function in the text section. For imported functions, the address is that of the

function's PLT stub. Every unique and imported function will have a PLT stub in the executable or shared library's non-lazy symbol pointer section.

Function values

Functions return their values according to type:

- **INTEGER** and **LOGICAL** of kind 1, 2, and 4 are returned (sign/zero extended) in R3.
- **INTEGER** and **LOGICAL** of kind 8 are returned in R3.
- **REAL(4)** or **REAL(8)** are returned in FP1. **REAL(16)** are returned in FP1 and FP2.
- **COMPLEX(4)** or **COMPLEX(8)** are returned in FP1 and FP2. **COMPLEX(16)** are returned in FP1-FP4.
- Individual vector results and other types that are processed in vector registers are returned in VR2. Homogeneous vector aggregates are returned in up to 8 vector registers VR2 to VR9.
- Character strings are returned in a buffer allocated by the caller. The address and the length of this buffer are passed in R3 and R4 as hidden parameters. The first explicit parameter doubleword is in R5, and all subsequent parameters are moved to the next doubleword.
- Homogeneous floating-point structures are returned in up to 8 FPRs FPR1 to FPR8. Homogeneous vector structures are returned in up to 8 VRs VR2 to VR9. Other structures up to 2 doublewords are returned in up to 2 GPRs R3 to R4. Other structures are returned in a buffer that is allocated by the caller. The address is passed in R3; there is no length. The first explicit parameter is in R4.

The stack floor

Stack floor is a system-defined address below which the stack cannot grow. All programs in the system must avoid accessing locations in the stack segment that are below the stack floor.

All programs must maintain other system invariants that are related to the stack:

- The stack pointer must always be quadword (16 byte) aligned.
- No data is saved or accessed from an address lower than the stack floor, except that locations within a small distance below the stack frame may be accessed before the stack is allocated or after it is deallocated, or without it ever being allocated.
- The stack pointer is always valid. You must take care to ensure that the stack pointer is changed in a single instruction. When allocating a new stack frame, the old stack pointer must be saved at the beginning of the new stack frame by that same instruction. When an allocation is of more than 32,767 bytes, an index register must be used instead of an immediate operand. This step ensures that there is no timing window where a signal handler would either overlay the stack data or erroneously appear to overflow the stack segment.

Stack overflow

The linkage convention requires no explicit inline check for overflow. The operating system uses a storage protection mechanism to detect stores past the end of the stack segment.

Prolog and epilog

You need to consider a number of steps when entering a procedure and when exiting a procedure.

On entry to a procedure, you might have to do some or all of the following steps:

1. Save the link register.
2. If the procedure uses any of the CR bits 8-23 (CR2, CR3, CR4), save the CR.
3. Save all nonvolatile FPRs that are used by this procedure in the FPR save area.
4. Save all nonvolatile VRs that are used by this procedure in the VR save area.
5. Save all nonvolatile GPRs that are used by this procedure in the GPR save area.
6. Atomically store the back chain and decrease the stack pointer by the size of the stack frame. Note that if a stack overflow occurs, it will be known immediately when the store of the back chain is done.

On exit from a procedure, you might have to perform some or all of the following steps:

1. Restore all GPRs saved that have been modified.
2. Restore all FPRs saved that have been modified.
3. Restore all VRs saved that have been modified.
4. Restore bits 8-23 of the CR (CR2, CR3, CR4) if they were used, if necessary.
5. Atomically restore the stack pointer to the value it had on entry.
6. Return to caller.

Traceback

XL Fortran supports the traceback mechanism, which symbolic debuggers need to unravel the call or return stack. Each object module has a traceback table in the text segment at the end of its code. This table contains information about the object module, including the type of object module, as well as stack frame and register information.

Note: You can make the traceback table smaller or remove it entirely with the **-qtbtable** option.

Chapter 10. Implementation details of XL Fortran Input/Output (I/O)

This topic describes XL Fortran support (through extensions and platform-specific details) for the Linux file system.

See “Mixed-language input and output” on page 260 for further considerations related to input and output operations.

Implementation details of file formats

The manner in which XL Fortran implements files is based on their file format.

Sequential-access unformatted files:

An integer that contains the length of the record precedes and follows each record. The length of the integer is 4 bytes if you set the **uwidth** runtime option to 32 (the default), and 8 bytes if you set the **uwidth** runtime option to 64.

Sequential-access formatted files:

XL Fortran programs break these files into records while reading, by using each newline character (X'0A') as a record separator.

On output, the input/output system writes a newline character at the end of each record. Programs can also write newline characters for themselves. This practice is not recommended because the effect is that the single record that appears to be written is treated as more than one record when being read or backspaced over.

Direct access files:

XL Fortran simulates direct-access files with operating system files whose length is a multiple of the record length of the XL Fortran file. You must specify, in an **OPEN** statement, the record length (**RECL**) of the direct-access file. XL Fortran uses this record length to distinguish records from each other.

For example, the third record of a direct-access file of record length 100 bytes would start at the 201st byte of the single record of a Linux file and end at the 300th byte.

If the length of the record of a direct-access file is greater than the total amount of data you want to write to the record, XL Fortran pads the record on the right with blanks (X'20').

Stream-access unformatted files:

Unformatted stream files are viewed as a collection of file storage units. In XL Fortran, a file storage unit is one byte.

A file connected for unformatted stream access has the following properties:

- The first file storage unit has position 1. Each subsequent file storage unit has a position that is one greater than that of the preceding one.
- For a file that can be positioned, file storage units need not be read or written in the order of their position. Any file storage unit may be read from the file while it is connected to a unit, provided that the file

storage unit has been written since the file was created, and if a READ statement for the connection is permitted.

Stream-access formatted files:

A record file connected for formatted stream access has the following properties:

- Some file storage units may represent record markers. The record marker is the newline character (X'0A').
- The file will have a record structure in addition to the stream structure.
- The record structure is inferred from the record markers that are stored in the file.
- Records can have any length up to the internal limit allowed by XL Fortran (See *XL Fortran Internal limits* in the *XL Fortran Compiler Reference*.)
- There may or may not be a record marker at the end of the file. If there is no record marker at the end of the file, the final record is incomplete, but not empty.

A file connected for formatted stream access has the following properties:

- The first file storage unit has position 1. Each subsequent file storage unit has a position that is greater than that of the preceding one. Unlike unformatted stream access, the positions of successive file storage units are not always consecutive.
- The position of a file connected for formatted stream access can be determined by the **POS=** specifier in an **INQUIRE** statement.
- For a file that can be positioned, the file position can be set to a value that was previously identified by the **POS=** specifier in **INQUIRE**.

Related information

- The **XLFRTIOPTS** environment variable

File names

There are a number of considerations to be aware of when working with file names.

You can specify file names as either relative (such as **file**, **dir/file**, or **./file**) or absolute (such as **/file** or **/dir/file**). The maximum length of a file name (the full path name) is 4095 characters, even if you only specify a relative path name in the I/O statement. The maximum length of a file name with no path is 255 characters.

You must specify a valid file name in such places as the following:

- The **FILE=** specifier of the **OPEN** and **INQUIRE** statements
- **INCLUDE** lines

Note: To specify a file whose location depends on an environment variable, you can use the **GET_ENVIRONMENT_VARIABLE** intrinsic procedure to retrieve the value of the environment variable:

```
character(100) home, name
call get_environment_variable('HOME', value=home)
! Now home = $HOME + blank padding.
! Construct the complete path name and open the file.
name=trim(home) // '/remainder/of/path'
open (unit=10, file=name)
...
end
```

Preconnected and implicitly connected files

Whether files are preconnected or implicitly connected is dependent on their units and specific statements.

Units 0, 5, and 6 are preconnected to standard error, standard input, and standard output, respectively, before the program runs.

All other units can be implicitly connected when an **ENDFILE**, **PRINT**, **READ**, **REWIND**, or **WRITE** statement is performed on a unit that has not been opened. Unit *n* is implicitly connected to a file that is named **fort.n**. These files need not exist, and XL Fortran does not create them unless you use the corresponding units implicitly.

Note: Because unit 0 is preconnected for standard error, you cannot use it for the **CLOSE**, **ENDFILE**, **BACKSPACE**, or **REWIND** statements with sequential input/output. You cannot use unit 0 for direct or stream input/output. You can use unit 0 in an **OPEN** statement only to change the values of the **BLANK=**, **DELIM=**, **DECIMAL=** or **PAD=** specifiers.

You can also implicitly connect units 5 and 6 (and *) by using I/O statements that follow a **CLOSE** of these units:

```
        WRITE (6,10) "This message goes to stdout."  
        CLOSE (6)  
        WRITE (6,10) "This message goes in the file fort.6."  
        PRINT *, "Output to * now also goes in fort.6."  
10     FORMAT (A)  
      END
```

The **FORM=** specifier of implicitly connected files has the value **FORMATTED** before any **READ**, **WRITE**, or **PRINT** statement is performed on the unit. The first such statement on such a file determines the **FORM=** specifier from that point on: **FORMATTED** if the formatting of the statement is format-directed, list-directed, or namelist; and **UNFORMATTED** if the statement is unformatted.

Preconnected files also have **FORM='FORMATTED'**, **STATUS='OLD'**, and **ACTION='READWRITE'** as default specifier values.

The other properties of a preconnected or implicitly connected file are the default specifier values for the **OPEN** statement. These files always use sequential access.

If you want XL Fortran to use your own file instead of the **fort.n** file, you can either specify your file for that unit through an **OPEN** statement or create a symbolic link before running the application. In the following example, there is a symbolic link between **myfile** and **fort.10**:

```
ln -s myfile fort.10
```

When you run an application that uses the implicitly connected file **fort.10** for input/output, XL Fortran uses the file **myfile** instead. The file **fort.10** exists, but only as a symbolic link. The following command will remove the symbolic link, but will not affect the existence of **myfile**:

```
rm fort.10
```

File positioning

The position of a file pointer when a file is opened with no **POSITION=** specifier is summarized in the following table.

Table 31. Position of the file pointer when a file is opened with no **POSITION=** specifier

-qposition suboptions	Implicit OPEN		Explicit OPEN					
			STATUS = 'NEW'		STATUS = 'OLD'		STATUS = 'UNKNOWN'	
	File exists	File does not exist	File exists	File does not exist	File exists	File does not exist	File exists	File does not exist
option not specified	Start	Start	Error	Start	Start	Error	Start	Start
appendold	Start	Start	Error	Start	End	Error	Start	Start
appendunknown	Start	Start	Error	Start	Start	Error	End	Start
appendold and appendunknown	Start	Start	Error	Start	End	Error	End	Start

I/O redirection

You can use the redirection operator on the command line to redirect input to and output from your XL Fortran program.

How you specify and use this operator depends on which shell you are running. Here is a **bash** example:

```
$ cat redirect.f
  write (6,*) 'This goes to standard output'
  write (0,*) 'This goes to standard error'
  read (5,*) i
  print *,i
  end
$ xlf95 redirect.f
** _main   === End of Compilation 1 ===
1501-510  Compilation successful for file redirect.f.
$ # No redirection. Input comes from the terminal. Output goes to
$ # the screen.
$ a.out
  This goes to standard output
  This goes to standard error
4
4
$ # Create an input file.
$ echo >stdin 2
$ # Redirect each standard I/O stream.
$ a.out >stdout 2>stderr <stdin
$ cat stdout
  This goes to standard output
2
$ cat stderr
  This goes to standard error
```

Refer to your man pages for more information on redirection.

How XL Fortran I/O interacts with pipes, special files, and links

You can access regular operating system files and blocked special files by using sequential-access, direct-access, or stream-access methods.

You can only access pseudo-devices, pipes, and character special files by using sequential-access methods, or stream-access without using the **POS=** specifier.

When you use symbolic link to link files together, you can use their names interchangeably, as shown in the following example:

```
OPEN (4, FILE="file1")
OPEN (4, FILE="link_to_file1", PAD="NO") ! Modify connection
```

Do not specify the **POSITION=** specifier as **REWIND** or **APPEND** for pipes.

Do not specify **ACTION='READWRITE'** for a pipe.

Do not use the **BACKSPACE** statement on files that are pseudo-devices or character special files.

Do not use the **REWIND** statement on files that are pseudo-devices or pipes.

Default record lengths

The default record lengths for files is dependent on the file format and on the **RECL=** qualifier.

If a pseudo-device, pipe, or character special file is connected for formatted or unformatted sequential access with no **RECL=** qualifier, or for formatted stream access, the default record length is 32 768 rather than 2 147 483 647, which is the default for sequential-access files connected to random-access devices. (See the **default_recl** runtime option in the *XL Fortran Compiler Reference*.)

In certain cases, the default maximum record length for formatted files is larger, to accommodate programs that write long records to standard output. If a unit is connected to a terminal for formatted sequential access and there is no explicit **RECL=** qualifier in the **OPEN** statement, the program uses a maximum record length of 2 147 483 646 ($2^{31}-2$) bytes, rather than the usual default of 32 768 bytes. When the maximum record length is larger, formatted I/O has one restriction: **WRITE** statements that use the **T** or **TL** edit descriptors must not write more than 32 768 bytes. This is because the unit's internal buffer is flushed each 32 768 bytes, and the **T** or **TL** edit descriptors will not be able to move back past this boundary.

File permissions

A file must have the appropriate permissions (read, write, or both) for the corresponding operation being performed on it.

When a file is created, the default permissions (if the **umask** setting is 000) are both read and write for user, group, and other. You can turn off individual permission bits by changing the **umask** setting before you run the program.

Selecting error messages and recovery actions

There are various ways to control a program's behavior when errors are encountered.

By default, an XL Fortran-compiled program continues after encountering many kinds of errors, even if the statements have no **ERR=** or **IOSTAT=** specifiers. The program performs some action that might allow it to recover successfully from the bad data or other problem.

To control the behavior of a program that encounters errors, set the **XLFRT_OPTS** environment variable, which is described in *Setting runtime options* in the *XL Fortran Compiler Reference*, before running the program:

- To make the program stop when it encounters an error instead of performing a recovery action, include **err_recovery=no** in the **XLFRT_OPTS** setting.
- To make the program stop issuing messages each time it encounters an error, include **xrf_messages=no**.
- To disallow XL Fortran extensions to Fortran 90 at run time, include **langlvl=90std**. To disallow XL Fortran extensions to Fortran 95 at run time, include **langlvl=95std**. To disallow XL Fortran extensions to Fortran 2003 behavior at run time, include **langlvl=2003std**. To disallow XL Fortran extensions to Fortran 2008 behavior at run time, include **langlvl=2008std**. These settings, in conjunction with the **-qlanglvl** compiler option, can help you locate extensions when preparing to port a program to another platform.

For example:

```
# Switch defaults for some runtime settings.
XLFRT_OPTS="err_recovery=no:cnverr=no"
export XLFRT_OPTS
```

If you want a program always to work the same way, regardless of environment-variable settings, or want to change the behavior in different parts of the program, you can call the **SETRT_OPTS** procedure:

```
PROGRAM RTOPTS
USE XLFUTILITY
CALL SETRT_OPTS("err_recovery=no") ! Change setting.
... some I/O statements ...
CALL SETRT_OPTS("err_recovery=yes") ! Change it back.
... some more I/O statements ...
END
```

Because a user can change these settings through the **XLFRT_OPTS** environment variable, be sure to use **SETRT_OPTS** to set all the runtime options that might affect the wanted operation of the program.

Flushing I/O buffers

To protect data from being lost if a program ends unexpectedly, you can use the **FLUSH** statement or the **flush_** subroutine to write any buffered data to a file.

The **FLUSH** statement is recommended for better portability and is used in the following example:

```
INTEGER, PARAMETER :: UNIT = 10
DO I = 1, 1000000
  WRITE(UNIT, *) I
  CALL MIGHT_CRASH
! If the program ends in the middle of the loop, some data
```

```

! may be lost.
END DO
DO I = 1, 1000000
  WRITE(UNIT, *) I
  FLUSH(UNIT)
  CALL MIGHT_CRASH
! If the program ends in the middle of the loop, all data written
! up to that point will be safely in the file.
END DO
END

```

Related information:

“Mixed-language input and output” on page 260



See FLUSH in the Compiler Reference

Choosing locations and names for Input/Output files

If you need to override the default locations and names for input/output files, you can use the following methods without making any changes to the source code.

Naming files that are connected with no explicit name

To give a specific name to a file that would usually have a name of the form **fort.unit**, you must set the runtime option **unit_vars** and then set an environment variable with a name of the form **XLFUNIT_unit** for each scratch file. The association is between a unit number in the Fortran program and a path name in the file system.

For example, suppose that the Fortran program contains the following statements:

```

OPEN (UNIT=1, FORM='FORMATTED', ACCESS='SEQUENTIAL', RECL=1024)
...
OPEN (UNIT=12, FORM='UNFORMATTED', ACCESS='DIRECT', RECL=131072)
...
OPEN (UNIT=123, FORM='UNFORMATTED', ACCESS='SEQUENTIAL', RECL=997)
XLFRT_OPTS="unit_vars=yes"      # Allow overriding default names.
XLFUNIT_1="/tmp/molecules.dat" # Use this named file.
XLFUNIT_12="./data/scratch"    # Relative to current directory.
XLFUNIT_123="/home/user/data/Users/username/data" # Somewhere besides /tmp.
export XLFRT_OPTS XLFUNIT_1 XLFUNIT_12 XLFUNIT_123

```

Notes:

1. The **XLFUNIT_number** variable name must be in uppercase, and *number* must not have any leading zeros.
2. **unit_vars=yes** might be only part of the value for the **XLFRT_OPTS** variable, depending on what other runtime options you have set. See *Setting runtime options* in the *XL Fortran Compiler Reference* for other options that might be part of the **XLFRT_OPTS** value.
3. If the **unit_vars** runtime option is set to **no** or is undefined or if the applicable **XLFUNIT_number** variable is not set when the program is run, the program uses a default name (**fort.unit**) for the file and puts it in the current directory.

Naming scratch files

To place all scratch files in a particular directory, set the **TMPDIR** environment variable to the name of the directory. The program then opens the scratch files in this directory. You might need to do this if your **/tmp** directory is too small to hold the scratch files.

To give a specific name to a scratch file, you must do the following:

1. Set the runtime option **scratch_vars**.
2. Set an environment variable with a name of the form **XLFSCRATCH_unit** for each scratch file.

The association is between a unit number in the Fortran program and a path name in the file system. In this case, the **TMPDIR** variable does not affect the location of the scratch file.

For example, suppose that the Fortran program contains the following statements:

```
OPEN (UNIT=1, STATUS='SCRATCH', &
      FORM='FORMATTED', ACCESS='SEQUENTIAL', RECL=1024)
...
OPEN (UNIT=12, STATUS='SCRATCH', &
      FORM='UNFORMATTED', ACCESS='DIRECT', RECL=131072)
...
OPEN (UNIT=123, STATUS='SCRATCH', &
      FORM='UNFORMATTED', ACCESS='SEQUENTIAL', RECL=997)
XLFRT_OPTS="scratch_vars=yes"      # Turn on scratch file naming.
XLFSCRATCH_1="/tmp/molecules.dat" # Use this named file.
XLFSCRATCH_12="./data/scratch"    # Relative to current directory.
XLFSCRATCH_123="/home/user/data/Users/username/data" # Somewhere besides /tmp.
export XLFRT_OPTS XLFSCRATCH_1 XLFSCRATCH_12 XLFSCRATCH_123
```

Notes:

1. The **XLFSCRATCH_number** variable name must be in uppercase, and *number* must not have any leading zeros.
2. **scratch_vars=yes** might be only part of the value for the **XLFRT_OPTS** variable, depending on what other runtime options you have set. See *Setting runtime options* in the *XL Fortran Compiler Reference* for other options that might be part of the **XLFRT_OPTS** value.
3. If the **scratch_vars** runtime option is set to **no** or is undefined or if the applicable **XLFSCRATCH_number** variable is not set when the program is run, the program chooses a unique file name for the scratch file and puts it in the directory named by the **TMPDIR** variable or in the **/tmp** directory if the **TMPDIR** variable is not set.

Asynchronous I/O

You may need to use asynchronous I/O for speed and efficiency in scientific programs that perform I/O for large amounts of data. Synchronous I/O blocks the execution of an application until the I/O operation completes. Asynchronous I/O allows an application to continue processing while the I/O operation is performed in the background.

You can modify applications to take advantage of the ability to overlap processing and I/O operations. Multiple asynchronous I/O operations can also be performed simultaneously. For a complete description of the syntax and language elements that you require to use this feature, see the following topics in the *XL Fortran Language Reference* :

- **INQUIRE** Statement
- **OPEN** Statement
- **READ** Statement
- **WAIT** Statement
- **WRITE** Statement

Execution of an asynchronous data transfer operation

The effect of executing an asynchronous data transfer operation will be as if the following steps were performed in the order specified, with steps (6)-(9) possibly occurring asynchronously:

1. Determine the direction of the data transfer.
2. Identify the unit.
3. Establish the format if one is present.
4. Determine whether an error condition, end-of-file condition, or end-of-record condition has occurred.
5. Cause the variable that you specified in the **IOSTAT=** specifier in the data transfer statement to become defined.
6. Position the file before you transfer data.
7. Transfer data between the file and the entities that you specified by the input/output list (if any).
8. Determine whether an error condition, end-of-file condition, or end-of-record condition has occurred.
9. Position the file after you transfer data.
10. Cause any variables that you specified in the **IOSTAT=** and **SIZE=** specifiers in the **WAIT** statement to become defined.

Usage

You can use Fortran asynchronous **READ** and **WRITE** statements to initiate asynchronous data transfers in Fortran. Execution continues after the asynchronous I/O statement, regardless of whether the actual data transfer has completed.

A program may synchronize itself with a previously initiated asynchronous I/O statement by using a **WAIT** statement. There are two forms of the **WAIT** statement:

1. In a **WAIT** statement without the **DONE=** specifier, the **WAIT** statement halts execution until the corresponding asynchronous I/O statement has completed:

```
integer idvar
integer, dimension(1000):: a
....
READ(unit_number, ID=idvar) a
....
WAIT(ID=idvar)
....
```

2. In a **WAIT** statement with the **DONE=** specifier, the **WAIT** statement returns the completion status of an asynchronous I/O statement:

```
integer idvar
logical done
integer, dimension(1000):: a
....
READ(unit_number, ID=idvar) a
....
WAIT(ID=idvar, DONE=done)
....
```

The variable you specified in the **DONE=** specifier is set to "true" if the corresponding asynchronous I/O statement completes. Otherwise, it is set to "false".

The actual data transfer can take place in the following cases:

- During the asynchronous **READ** or **WRITE** statement

- At any time before the execution of the corresponding **WAIT** statement
- During the corresponding **WAIT** statement

Because of the nature of asynchronous I/O, the actual completion time of the request cannot be predicted.

You can specify asynchronous **READ** and **WRITE** statements by using the **ID=** specifier. The value set for the **ID=** specifier by an asynchronous **READ** or **WRITE** statement must be the same value specified in the **ID=** specifier in the corresponding **WAIT** statement. You must preserve this value until the associated asynchronous I/O statement has completed.

The following program shows a valid asynchronous **WRITE** statement:

```

program sample0
  integer, dimension(1000):: a
  integer idvar
  a = (/ (i,i=1,1000) /)
  WRITE(10,ID=idvar) a
  WAIT(ID=idvar)
end

```

The following program is not valid, because the value of the asynchronous I/O identifier in variable *idvar* is destroyed before the associated **WAIT** statement:

```

program sample1
  integer, dimension(1000):: a
  integer idvar
  a = (/ (i,i=1,1000) /)
  WRITE(10,ID=idvar) a
  idvar = 999 ! Valid id is destroyed.
  WAIT(ID=idvar)
end

```

An application that uses asynchronous I/O typically improves performance by overlapping processing with I/O operations. The following is a simple example:

```

program sample2
  integer (kind=4), parameter :: isize=1000000, icol=5
  integer (kind=4) :: i, j, k
  integer (kind=4), dimension(icol) :: handle
  integer (kind=4), dimension(isize,icol), static :: a, a1

!
!   Opens the file for both synchronous and asynchronous I/O.
!
  open(20,form="unformatted",access="direct", &
       status="scratch",recl=isize*4,asynch="yes")

!
!   This loop overlaps the initialization of a(:,j) with
!   asynchronous write statements.
!
!   NOTE: The array is written out one column at a time.
!         Since the arrays in Fortran are arranged in column
!         major order, each WRITE statement writes out a
!         contiguous block of the array.
!
  do 200 j = 1, icol
    a(:,j) = (/ (i*j,i=1,isize) /)
    write(20, id=handle(j), rec=j) a(:,j)
200  end do

!
!   Wait for all writes to complete before reading.
!

```

```

do 300 j = 1, icol
  wait(id=handle(j))
300  end do

!
! Reads in the first record.
!
read(20, id=handle(1), rec=1) a1(:,1)

do 400 j = 2, icol
  k = j - 1
!
!   Waits for a previously initiated read to complete.
!
  wait(id=handle(k))
!
!   Initiates the next read immediately.
!
  read(20, id=handle(j), rec=j) a1(:,j)
!
!   While the next read is going on, we do some processing here.
!
  do 350 i = 1, isize
    if (a(i,k) .ne. a1(i,k)) then
      print *, "(",i,",",k,") &
        & expected ", a(i,k), " got ", a1(i,k)
    end if
350  end do
400  end do

!
! Finish the last record.
!
  wait(id=handle(icol))

do 450 i = 1, isize
  if (a(i,icol) .ne. a1(i,icol)) then
    print *, "(",i,",",icol,") &
      & expected ", a(i,icol), " got ", a1(i,icol)
  end if
450  end do

  close(20)
end

```

Performance

To maximize the benefits of asynchronous I/O, you should only use it for large contiguous data items.

It is possible to perform asynchronous I/O on a large number of small items, but the overall performance will suffer. This is because extra processing overhead is required to maintain each item for asynchronous I/O. Performing asynchronous I/O on a larger number of small items is strongly discouraged. The following are two examples:

1. WRITE(unit_number, ID=idvar) a1(1:10000000:2)
2. WRITE(unit_number, ID=idvar) (a2(i,j),j=1,10000000)

Performing asynchronous I/O on unformatted sequential files is less efficient. This is because each record might have a different length, and these lengths are stored with the records themselves. You should use unformatted direct access or unformatted stream access, if possible, to maximize the benefits of asynchronous I/O.

Compiler-generated temporary I/O items

There are situations when the compiler must generate a temporary variable to hold the result of an I/O item expression. In such cases, synchronous I/O is performed on the temporary variable, regardless of the mode of transfer that you specified in the I/O statement. The following are examples of such cases:

1. For **READ**, when an array with vector subscripts appears as an input item:

a.

```
integer a(5), b(3)
b = (/1,3,5/)
read(99, id=i) a(b)
```

b.

```
real a(10)
read(99, id=i) a(/1,3,5/)
```

2. For **WRITE**, when an output item is an expression that is a constant or a constant of certain derived types:

a.

```
write(99, id=i) 1000
```

b.

```
integer a
parameter(a=1000)
```

```
write(99, id=i) a
```

c.

```
type mytype
integer a
integer b
end type mytype
```

```
write(99, id=i) mytype(4,5)
```

3. For **WRITE**, when an output item is a temporary variable:

a.

```
write(99, id=i) 99+100
```

b.

```
write(99, id=i) a+b
```

c.

```
external ff
real(8) ff
```

```
write(99, id=i) ff()
```

4. For **WRITE**, when an output item is an expression that is an array constructor:

```
write(99, id=i) (/1,2,3,4,5/)
```

5. For **WRITE**, when an output item is an expression that is a scalarized array:

```
integer a(5), b(5)
write(99, id=i) a+b
```

Error handling

For an asynchronous data transfer, errors or end-of-file conditions might occur either during execution of the data transfer statement or during subsequent data transfer. If these conditions do not result in the termination of the program, you can detect these conditions via **ERR=**, **END=** and **IOSTAT=** specifiers in the data transfer or in the matching **WAIT** statement.

Execution of the program terminates if an error condition occurs during execution or during subsequent data transfer of an input/output statement that contains neither an **IOSTAT=** nor an **ERR=** specifier. In the case of a recoverable error, if the **IOSTAT=** and **ERR=** specifiers are not present, the program terminates if you set the **err_recovery** runtime option to **no**. If you set the **err_recovery** runtime option to **yes**, recovery action occurs, and the program continues.

If an asynchronous data transfer statement causes either of the following events, a matching **WAIT** statement cannot run, because the **ID=** value is not defined:

- A branch to the label that you specified by **ERR=** or **END=**
- The **IOSTAT=** specifier to be set to a non-zero value

XL Fortran thread-safe I/O library

The XL Fortran runtime library **libxlf90_r.so** provides support for parallel execution of Fortran I/O statements.

Synchronization of I/O operations

During parallel execution, multiple threads might perform I/O operations on the same file at the same time. If they are not synchronized, the results of these I/O operations could be shuffled or merged or both, and the application might produce incorrect results or even terminate. The XL Fortran runtime library synchronizes I/O operations for parallel applications. It performs the synchronization within the I/O library, and it is transparent to application programs. The purpose of the synchronization is to ensure the integrity and correctness of each individual I/O operation. However, the run time does not have control over the order in which threads execute I/O statements. Therefore, the order of records read in or written out is not predictable under parallel I/O operations. Refer to “Parallel I/O issues” for details.

External files

For external files, the synchronization is performed on a per-unit basis. The XL Fortran run time ensures that only one thread can access a particular logical unit to prevent several threads from interfering with each other. When a thread is performing an I/O operation on a unit, other threads attempting to perform I/O operations on the same unit must wait until the first thread finishes its operation. Therefore, the execution of I/O statements by multiple threads on the same unit is serialized. However, the runtime environment does not prevent threads from operating on different logical units in parallel. In other words, parallel access to different logical units is not necessarily serialized.

Functionality of I/O under synchronization

The XL Fortran runtime sets its internal locks to synchronize access to logical units. This should not have any functional impact on the I/O operations performed by a Fortran program. Also, it will not impose any additional restrictions to the operability of Fortran I/O statements except for the use of I/O statements in a signal handler that is invoked asynchronously. Refer to “Use of I/O statements in signal handlers” on page 295 for details.

Parallel I/O issues

The order in which parallel threads perform I/O operations is not predictable. The XL Fortran run time does not have control over the ordering. It will allow whichever thread that executes an I/O statement on a particular logical unit and obtains the lock on it first to proceed with the operation. Therefore, only use parallel I/O in cases where at least one of the following is true:

- Each thread performs I/O on a predetermined record in direct-access files.
- Each thread performs I/O on a different part of a stream-access file. Different I/O statements cannot use the same, or overlapping, areas of a file.
- The result of an application does not depend on the order in which records are written out or read in.
- Each thread performs I/O on a different file.

In these cases, results of the I/O operations are independent of the order in which threads execute. However, you might not get the performance improvements that you expect, since the I/O library serializes parallel access to the same logical unit from multiple threads. Examples of these cases are as follows:

- Each thread performs I/O on a pre-determined record in a direct-access file:

```
do i = 1, 10
  write(4, '(i4)', rec = i) a(i)
enddo
```

- Each thread performs I/O on a different part of a stream-access file. Different I/O statements cannot use the same, or overlapping, areas of a file.

```
do i = 1, 9
  write(4, '(i4)', pos = 1 + 5 * (i - 1)) a(i)
  ! We use 5 above because i4 takes 4 file storage
  ! units + 1 file storage unit for the record marker.
enddo
```

- In the case that each thread operates on a different file, since threads share the status of the logical units connected to the files, the thread still needs to obtain the lock on the logical unit for either retrieving or updating the status of the logical unit. However, the runtime allows threads to perform the data transfer between the logical unit and the I/O list item in parallel. If an application contains a large number of small I/O requests in a parallel region, you might not get the expected performance because of the lock contention. Consider the following example:

```
program example

use omp_lib

integer, parameter :: num_of_threads = 4, max = 5000000
character*10 file_name
integer i, file_unit, thread_id
integer, dimension(max, 2 * num_of_threads) :: aa

call omp_set_num_threads(num_of_threads)

!$omp parallel private(file_name, thread_id, file_unit, i) shared(aa)

  thread_id = omp_get_thread_num()
  file_name = 'file_'
  file_name(6:6) = char(ichar('0') + thread_id)
  file_unit = 10 + thread_id

  open(file_unit, file = file_name, status = 'old', action = 'read')

  do i = 1, max
    read(file_unit, *) aa(i, thread_id * 2 + 1), aa(i, thread_id * 2 + 2)
  end do

  close(file_unit)

!$omp end parallel
end
```

The XL Fortran runtime synchronizes retrieving and updating the status of the logical units while performing data transfer in parallel. In order to increase performance, it is recommended to increase the size of data transfer per I/O request. The do loop, therefore, should be rewritten as follows:

```
read(file_unit, *) a(:, thread_id * 2 + 1 : thread_id * 2 + 2)

do i = 1, max
  ! Do something for each element of array 'aa'.
end do
```

- The result does not depend on the order in which records are written out or read in:

```
real a(100)
do i = 1, 10
  read(4) a(i)
enddo
call qsort_(a)
```

- Each thread performs I/O on a different logical unit of direct access, sequential access, or stream access:

```
do i = 11, 20
  write(i, '(i4)') a(i - 10)
enddo
```

For multiple threads to write to or read from the same sequential-access file, or to write to or read from the same stream-access file without using the **POS=** specifier, the order of records written out or read in depends on the order in which the threads execute the I/O statement on them. This order, as stated previously, is not predictable. Therefore, the result of an application could be incorrect if it assumes records are sequentially related and cannot be arbitrarily written out or read in. For example, if the following loop is parallelized, the numbers printed out will no longer be in the sequential order from 1 to 500 as the result of a serial execution:

```
do i = 1, 500
  print *, i
enddo
```

Applications that depend on numbers being strictly in the specified order will not work correctly.

The XL Fortran runtime option **multconn=yes** allows connection of the same file to more than one logical unit simultaneously. Since such connections can only be made for reading (**ACCESS='READ'**), access from multiple threads to logical units that are connected to the same file will produce predictable results.

Use of I/O statements in signal handlers

There are basically two kinds of signals in the POSIX signal model: *synchronously* and *asynchronously* generated signals. Signals caused by the execution of some code of a thread, such as a reference to an unmapped, protected, or bad memory (**SIGSEGV** or **SIGBUS**), floating-point exception (**SIGFPE**), execution of a trap instruction (**SIGTRAP**), or execution of illegal instructions (**SIGILL**) are said to be synchronously generated. Signals may also be generated by events outside the process: for example, **SIGINT**, **SIGHUP**, **SIGQUIT**, **SIGIO**, and so on. Such events are referred to as interrupts. Signals that are generated by interrupts are said to be asynchronously generated.

The XL Fortran run time is asynchronous signal unsafe. This means that an XL Fortran I/O statement cannot be used in a signal handler that is entered because of an asynchronously generated signal. The behavior of the system is undefined when

an XL Fortran I/O statement is called from a signal handler that interrupts an I/O statement. However, it is safe to use I/O statements in signal handlers for synchronous signals.

Sometimes an application can guarantee that a signal handler is not entered asynchronously. For example, an application might mask signals except when it runs certain known sections of code. In such situations, the signal will not interrupt any I/O statements and other asynchronous signal unsafe functions. Therefore, you can still use Fortran I/O statements in an asynchronous signal handler.

A much easier and safer way to handle asynchronous signals is to block signals in all threads and to explicitly wait (using `sigwait()`) for them in one or more separate threads. The advantage of this approach is that the **handler** thread can use Fortran I/O statements as well as other asynchronous signal unsafe routines.

Asynchronous thread cancellation

When a thread enables asynchronous thread cancellability, any cancellation request is acted upon immediately.

The XL Fortran runtime environment is not asynchronous thread cancellation safe. The behavior of the system is undefined if a thread is cancelled asynchronously while it is in the XL Fortran runtime environment.

Chapter 11. Implementation details of XL Fortran floating-point processing

This topic answers some common questions about floating-point processing.

- How can I get predictable, consistent results?
- How can I get the fastest or the most accurate results?
- How can I detect, and possibly recover from, exception conditions?
- Which compiler options can I use for floating-point calculations?

The topics describing floating-point precision make frequent reference to the compiler options that are grouped together in *Floating-point and integer control* in the *XL Fortran Compiler Reference*, especially the **-qfloat** option. The XL Fortran compiler also provides three intrinsic modules for exception handling and IEEE arithmetic support to help you write IEEE module-compliant code that can be more portable. See *IEEE Modules and Support* in the *XL Fortran Language Reference* for details.

The use of the compiler options for floating-point calculations affects the accuracy, performance, and possibly the correctness of floating-point calculations. Although the default values for the options were chosen to provide efficient and correct execution of most programs, you may need to specify nondefault options for your applications to work the way you want. We strongly advise you to read this section before using these options.

Note: The discussions of single-precision, double-precision, and extended-precision calculations in this section all refer to the default situation, with **-qrealize=4** and no **-qautodbl** specified. If you change these settings, keep in mind that the size of a Fortran **REAL**, **DOUBLE PRECISION**, and so on may change, but single precision, double precision, and extended precision (in lowercase) still refer to 4-, 8-, and 16-byte entities respectively.

IEEE floating-point overview

The *ANSI/IEEE Standard for Binary Floating-Point Arithmetic, ANSI/IEEE Std 754-1985 and IEEE Std 754-2008* and the details of how it applies to XL Fortran on specific hardware platforms, are summarized in the following topics.

For information on the Fortran 2003 IEEE Module and arithmetic support, see the *XL Fortran Language Reference*.

Compiling for strict IEEE conformance

By default, XL Fortran follows most, but not all of the rules in the IEEE standard. To compile for strict compliance with the standard:

- Use the compiler option **-qfloat=nomaf**.
- If the program changes the rounding mode at run time, include **rrm** among the **-qfloat** suboptions.
- If the data or program code contains signaling NaN values (NaN), include **nans** among the **-qfloat** suboptions. (A signaling NaN is different from a quiet NaN; you must explicitly code it into the program or data or create it by using the **-qinitauto** or **-qinitalloc** compiler option.)

- If you are compiling with **-O3**, or a higher base optimization level, include the **-qstrict** option after it. You can also use the **-qstrict** suboptions to refine the level of control for the transformations performed by the optimizers.

Related reference:



See **-qstrict** in the Compiler Reference

IEEE single-precision and double-precision values

XL Fortran encodes single-precision and double-precision values in IEEE format. For the range and representation, see *Real* in the *XL Fortran Language Reference*.

IEEE extended-precision values

The IEEE standard suggests, but does not mandate, a format for extended-precision values. XL Fortran does not use this format.

“Extended-precision values” on page 301 describes the format that XL Fortran uses.

Infinities and NaNs

For single-precision real values:

- Positive infinity is represented by the bit pattern X'7F80 0000'.
- Negative infinity is represented by the bit pattern X'FF80 0000'.
- A signaling NaN is represented by any bit pattern between X'7F80 0001' and X'7FBF FFFF' or between X'FF80 0001' and X'FFBF FFFF'.
- A quiet NaN is represented by any bit pattern between X'7FC0 0000' and X'7FFF FFFF' or between X'FFC0 0000' and X'FFFF FFFF'.

For double-precision real values:

- Positive infinity is represented by the bit pattern X'7FF00000 00000000'.
- Negative infinity is represented by the bit pattern X'FFF00000 00000000'.
- A signaling NaN is represented by any bit pattern between X'7FF00000 00000001' and X'7FF7FFFF FFFFFFFF' or between X'FFF00000 00000001' and X'FFF7FFFF FFFFFFFF'.
- A quiet NaN is represented by any bit pattern between X'7FF80000 00000000' and X'7FFFFFFF FFFFFFFF' or between X'FFF80000 00000000' and X'FFFFFFF FFFFFFFF'.

These values do not correspond to any Fortran real constants. You can generate all of these by encoding the bit pattern directly, or by using the **ieee_value** function provided in the **ieee_arithmetic** intrinsic module. Using the **ieee_value** function is the preferred programming technique, as it is allowed by the Fortran 2003 standard and the results are portable. Encoding the bit pattern directly could cause portability problems on machines using different bit patterns for the different values. All except signaling NaN values can occur as the result of arithmetic operations:

```

$ cat fp_values.f
real plus_inf, minus_inf, plus_nanq, minus_nanq, nans
real large

data plus_inf /z'7f800000'/
data minus_inf /z'ff800000'/
data plus_nanq /z'7fc00000'/
data minus_nanq /z'ffc00000'/
data nans /z'7f800001'/

print *, 'Special values:', plus_inf, minus_inf, plus_nanq, minus_nanq, nans

! They can also occur as the result of operations.
large = 10.0 ** 200
print *, 'Number too big for a REAL:', large * large
print *, 'Number divided by zero:', (-large) / 0.0
print *, 'Nonsensical results:', plus_inf - plus_inf, sqrt(-large)

! To find if something is a NaN, compare it to itself.
print *, 'Does a quiet NaN equal itself:', plus_nanq .eq. plus_nanq
print *, 'Does a signaling NaN equal itself:', nans .eq. nans
! Only for a NaN is this comparison false.

end
$ xlf95 -o fp_values fp_values.f
** _main === End of Compilation 1 ===
1501-510 Compilation successful for file fp_values.f.
$ fp_values
Special values: INF -INF NAN -NAN NAN
Number too big for a REAL: INF
Number divided by zero: -INF
Nonsensical results: NAN NAN
Does a quiet NaN equal itself: F
Does a signaling NaN equal itself: F

```

Exception-handling model

The IEEE standard defines several exception conditions that can occur:

OVERFLOW

The exponent of a value is too large to be represented.

UNDERFLOW

A nonzero value is so small that it cannot be represented without an extraordinary loss of accuracy. The value can be represented only as zero or a subnormal number (denorm).

ZERODIVIDE

A finite nonzero value is divided by zero.

INVALID

Operations are performed on values for which the results are not defined. These include:

- Operations on signaling NaN values
- infinity - same infinity, or infinity + opposite infinity
- 0.0 * infinity
- 0.0 / 0.0
- mod(x,y) or ieee_rem(x,y) (or other remainder functions) when x is infinite or y is zero
- The square root of a negative number except -0.0
- Conversion of a floating-point number to an integer when the converted value cannot be represented faithfully

- Comparisons involving NaN values

INEXACT

A computed value cannot be represented exactly, so a rounding error is introduced. (This exception is very common.)

XL Fortran always detects these exceptions when they occur, but by default does not take any special action. Calculation continues, usually with a NaN or infinity value as the result. If you want to be automatically informed when an exception occurs, you can turn on exception trapping through compiler options or calls to intrinsic subprograms. However, different results, intended to be manipulated by exception handlers, are produced:

Table 32. Results of IEEE exceptions, with and without trapping enabled

	Overflow	Underflow	Zerodivide	Invalid	Inexact
Exceptions not enabled (default)	INF	Subnormal number or zero	INF	NaN	Rounded result
Exceptions enabled	Unnormalized number with biased exponent	Unnormalized number with biased exponent	No result	No result	Rounded result

Note: Because different results are possible, it is very important to make sure that any exceptions that are generated are handled correctly. See “Detecting and trapping floating-point exceptions” on page 306 for instructions on doing so.

Hardware-specific floating-point overview

Single-precision and double-precision values and extended-precision values for hardware-specific floating-point processing are described in the following topics.

Single-precision and double-precision values

The PowerPC floating-point hardware performs calculations in either IEEE single-precision (equivalent to **REAL(4)** in Fortran programs) or IEEE double-precision (equivalent to **REAL(8)** in Fortran programs).

Keep the following considerations in mind:

- Double precision provides greater range (approximately $10^{*(-308)}$ to 10^{*308}) and precision (about 15 decimal digits) than single precision (approximate range $10^{*(-38)}$ to 10^{*38} , with about 7 decimal digits of precision).
- Computations that mix single and double operands are performed in double precision, which requires conversion of the single-precision operands to double-precision. These conversions do not affect performance.
- Double-precision values that are converted to single-precision (such as when you specify the **SNGL** intrinsic or when a double-precision computation result is stored into a single-precision variable) require rounding operations. A rounding operation produces the correct single-precision value, which is based on the IEEE rounding mode in effect. The value may be less precise than the original double-precision value, as a result of rounding error. Conversions from double-precision values to single-precision values may reduce the performance of your code.
- Programs that manipulate large amounts of floating-point data may run faster if they use **REAL(4)** rather than **REAL(8)** variables. (You need to ensure that **REAL(4)** variables provide you with acceptable range and precision.) The

programs may run faster because the smaller data size reduces memory traffic, which can be a performance bottleneck for some applications.

The floating-point hardware also provides a special set of double-precision operations that multiply two numbers and add a third number to the product. These combined multiply-add (**MAF**) operations are performed at the same speed at which either an individual multiply or add is performed. The **MAF** functions provide an extension to the IEEE 754-1985 standard (but are in the 754-2008 standard) because they perform the multiply and add with one (rather than two) rounding errors. The **MAF** functions are faster and more accurate than the equivalent separate operations.

Extended-precision values

XL Fortran extended precision is not in the **binary128** format suggested by the IEEE standard. The IEEE standard suggests extended formats use more bits in the exponent for greater range and the fraction for greater precision.

XL Fortran extended precision, equivalent to **REAL(16)** in Fortran programs, is implemented in software. Extended precision provides the same range as double precision (about $10^{*(-308)}$ to 10^{*308}) but more precision (a variable amount, about 31 decimal digits or more). The software support is restricted to round-to-nearest mode. Programs that use extended precision must ensure that this rounding mode is in effect when extended-precision calculations are performed. For the different ways you can control the rounding mode, see “Selecting the rounding mode” on page 302.

Programs that specify extended-precision values as hexadecimal, octal, binary, or Hollerith constants must follow these conventions:

- Extended-precision numbers are composed of two double-precision numbers with different magnitudes that do not overlap (except when the number is zero or close to zero). That is, the binary exponents differ by at least the number of fraction bits in a **REAL(8)**. The high-order double-precision value (the one that comes first in storage) must have the larger magnitude. The value of the extended-precision number is the sum of the two double-precision values.
- For a value of NaN or infinity, you must encode one of these values within the high-order double-precision value. The low-order value is not significant except that it cannot be set to NaN when the high-order value is infinity.

Because an XL Fortran extended-precision value can be the sum of two values with greatly different exponents, leaving a number of assumed zeros in the fraction, the format actually has a variable precision with a minimum of about 31 decimal digits. You get more precision in cases where the exponents of the two double values differ in magnitude by more than the number of digits in a double-precision value. This encoding allows an efficient implementation intended for applications requiring more precision but no more range than double precision.

Note:

1. In the discussions of rounding errors because of compile-time folding of expressions, keep in mind that this folding produces different results for extended-precision values more often than for other precisions.
2. Special numbers, such as NaN, infinity, and negative zero, are not fully supported by the extended-precision values. Arithmetic operations do not necessarily propagate these numbers in extended precision.

3. XL Fortran does not always detect floating-point exception conditions (see “Detecting and trapping floating-point exceptions” on page 306) for extended-precision values. If you turn on floating-point exception trapping in programs that use extended precision, XL Fortran may also generate signals in cases where an exception condition does not really occur.
4. The exact representation is sometimes different between AIX® and Linux.
5. Not all math library functions are available for extended precision.

How XL Fortran rounds floating-point calculations

Understanding rounding operations in XL Fortran can help you get predictable, consistent results. It can also help you make informed decisions when you have to make tradeoffs between speed and accuracy.

In general, floating-point results from XL Fortran programs are more accurate than those from other implementations because of **MAF** operations and the higher precision used for intermediate results. If identical results are more important to you than the extra precision and performance of the XL Fortran defaults, read “Duplicating the floating-point results of other systems” on page 305.

Selecting the rounding mode

To change the rounding mode in a program, you can call the **fpsets** and **fpgets** routines, which use an array of logicals named **fpstat**, defined in the include files `/opt/ibm/xlf/15.1.0/include/fpdt.h` and `/opt/ibm/xlf/15.1.0/include/fpdc.h`. The **fpstat** array elements correspond to the bits in the floating-point status and control register. They correspond to the lower half of the FPSCR bits.

For floating-point rounding control, the array elements **fpstat(fprn1)** and **fpstat(fprn2)** are set as specified in the following table:

Table 33. Rounding-mode bits to use with fpsets and fpgets

fpstat(fprn1)	fpstat(fprn2)	Rounding Mode Enabled
.true.	.true.	Round towards -infinity.
.true.	.false.	Round towards +infinity.
.false.	.true.	Round towards zero.
.false.	.false.	Round to nearest.

For example:

```

program fptest
  include 'fpdc.h'

  call fpgets( fpstat ) ! Get current register values.
  if ( (fpstat(fprn1) .eqv. .false.) .and. +
      (fpstat(fprn2) .eqv. .false.)) then
    print *, 'Before test: Rounding mode is towards nearest'
    print *, '          2.0 / 3.0 = ', 2.0 / 3.0
    print *, '          -2.0 / 3.0 = ', -2.0 / 3.0
  end if

  call fpgets( fpstat ) ! Get current register values.
  fpstat(fprn1) = .TRUE. ! These 2 lines mean round towards
  fpstat(fprn2) = .FALSE. ! +infinity.
  call fpsets( fpstat )
  r = 2.0 / 3.0
  print *, 'Round towards +infinity: 2.0 / 3.0= ', r

```

```

        call fpgets( fpstat ) ! Get current register values.
        fpstat(fprn1) = .TRUE. ! These 2 lines mean round towards
        fpstat(fprn2) = .TRUE. ! -infinity.
        call fpsets( fpstat )
        r = -2.0 / 3.0
        print *, 'Round towards -infinity: -2.0 / 3.0= ', r
    end
! This block data program unit initializes the fpstat array, and so on.
    block data
        include 'fpdc.h'
        include 'fpdt.h'
    end

```

XL Fortran also provides several procedures that allow you to control the floating-point status and control register of the processor directly. These procedures are more efficient than the **fpsets** and **fpgets** subroutines because they are mapped into inlined machine instructions that manipulate the floating-point status and control register (fpscr) directly.

XL Fortran supplies the **get_round_mode()** and **set_round_mode()** procedures in the `xl_f_fp_util` module. These procedures return and set the current binary floating-point rounding mode, respectively.

For example:

```

program fptest
    use, intrinsic :: xlf_fp_util
    integer(fpscr_kind) old_fpscr
    if ( get_round_mode() == fp_rnd_rn ) then
        print *, 'Before test: Rounding mode is towards nearest'
        print *, '          2.0 / 3.0 = ', 2.0 / 3.0
        print *, '          -2.0 / 3.0 = ', -2.0 / 3.0
    end if

    old_fpscr = set_round_mode( fp_rnd_rp )
    r = 2.0 / 3.0
    print *, 'Round towards +infinity: 2.0 / 3.0 = ', r

    old_fpscr = set_round_mode( fp_rnd_rm )
    r = -2.0 / 3.0
    print *, 'Round towards -infinity: -2.0 / 3.0 = ', r
end

```

XL Fortran supplies the **ieee_get_rounding_mode()** and **ieee_set_rounding_mode()** procedures in the `ieee_arithmetic` module. These portable procedures retrieve and set the current floating-point rounding mode, respectively.

For example:

```

program fptest
    use, intrinsic :: ieee_arithmetic
    type(ieee_round_type) current_mode
    call ieee_get_rounding_mode( current_mode )
    if ( current_mode == ieee_nearest ) then
        print *, 'Before test: Rounding mode is towards nearest'
        print *, '          2.0 / 3.0 = ', 2.0 / 3.0
        print *, '          -2.0 / 3.0 = ', -2.0 / 3.0
    end if

    call ieee_set_rounding_mode( ieee_up )
    r = 2.0 / 3.0
    print *, 'Round towards +infinity: 2.0 / 3.0 = ', r
end

```

```

call ieee_set_rounding_mode( ieee_down )
r = -2.0 / 3.0
print *, 'Round towards -infinity: -2.0 / 3.0 = ', r
end

```

Notes:

1. Extended-precision floating-point values must only be used in round-to-nearest mode.
2. For thread-safety and reentrancy, the include file `/opt/ibm/xlf/15.1.0/include/fpdc.h` contains a **THREADLOCAL** directive that is protected by the trigger constant **IBMT**. The invocation commands `xlf_r`, `xlf90_r`, `xlf95_r`, `xlf2003_r`, `xlf2008_r`, and `xlcfuf` turn on the **-qthreaded** compiler option by default, which in turn implies the trigger constant **IBMT**. If you are including the file `/opt/ibm/xlf/15.1.0/include/fpdc.h` in code that is not intended to be threadsafe, do not specify **IBMT** as a trigger constant.
3. Compile a program that changes the rounding mode with **-qfloat=rrm**.

Minimizing rounding errors

There are several strategies for handling rounding errors and other unexpected, slight differences in calculated results. You may want to consider one or more of the following strategies:

- Minimizing the amount of overall rounding
- Delaying as much rounding as possible to run time
- Ensuring that if some rounding is performed in a mode other than round-to-nearest, *all* rounding is performed in the same mode

Minimizing overall rounding

Rounding operations, especially in loops, reduce code performance and may have a negative effect on the precision of computations. Consider using double-precision variables instead of single-precision variables when you store the temporary results of single-precision calculations, and delay rounding operations until the final result is computed.

Delaying rounding until run time

The compiler evaluates floating-point expressions during compilation when it can, so that the resulting program does not run more slowly due to unnecessary runtime calculations. However, the results of the compiler's evaluation might not match exactly the results of the runtime calculation. To delay these calculations until run time, specify the **nofold** suboption of the **-qfloat** option.

The results may still not be identical; for example, calculations in **DATA** and **PARAMETER** statements are still performed at compile time.

The differences in results due to **fold** or **nofold** are greatest for programs that perform extended-precision calculations or are compiled with the **-O** option or both.

Ensuring that the rounding mode is consistent

You can change the rounding mode from its default setting of round-to-nearest. (See for examples.) If you do so, you must be careful that *all* rounding operations for the program use the same mode:

- Specify the equivalent setting on the **-qieee** option, so that any compile-time calculations use the same rounding mode.

- Specify the **rrm** suboption of the **-qfloat** option, so that the compiler does not perform any optimizations that require round-to-nearest rounding mode to work correctly.

For example, you might compile a program like the one in “Selecting the rounding mode” on page 302 with this command if the program consistently uses round-to-plus-infinity mode:

```
xlf95 -qieee=plus -qfloat=rrm changes_rounding_mode.f
```

Duplicating the floating-point results of other systems

To duplicate the double-precision results of programs on systems with different floating-point architectures (without multiply-add instructions), specify the **nomaf** suboption of the **-qfloat** option. This suboption prevents the compiler from generating any multiply-add or multiply-subtract instructions except the following cases:

- Instructions used in the **COMPLEX** operations
- Instructions required for multiply-add or multiply-subtract built in functions or the **fma** function

This results in decreased accuracy and performance but provides strict conformance to the IEEE standard for double-precision arithmetic.

To duplicate the results of programs where the default size of **REAL** items is different from that on systems running XL Fortran, use the **-qrealsize** option to change the default **REAL** size when compiling with XL Fortran.

If the system whose results you want to duplicate preserves full double precision for default real constants that are assigned to **DOUBLE PRECISION** variables, use the **-qdpc** or **-qrealsize** option.

If results consistent with other systems are important to you, include **norsqrt** and **nofold** in the settings for the **-qfloat** option.

If you specify the option **-O3**, **-O4**, or **-O5**, include **-qstrict** and any necessary suboptions too.

Related information:



See **-qarch** in the Compiler Reference



See **-qfloat** in the Compiler Reference



See **-qrealsize** in the Compiler Reference



See **-qstrict** in the Compiler Reference

Maximizing floating-point performance

If performance is your primary concern and you want your program to be relatively safe but do not mind if results are slightly different (generally more precise) from what they would be otherwise, optimize the program with the **-O** option, and specify **-qfloat=rsqrt:hssngl**.

The following topics describe the functions of these suboptions:

- The **rsqrt** suboption replaces division by a square root with multiplication by the reciprocal of the root, a faster operation that may not produce precisely the same result.
- The **hssngl** suboption improves the performance of single-precision (**REAL(4)**) floating-point calculations by suppressing rounding operations that are required by the Fortran language but are not necessary for correct program execution. The results of floating-point expressions are kept in double precision where the original program would round them to single-precision. These results are then used in some later expressions instead of the rounded results.

To detect single-precision floating-point overflows and underflows, rounding operations are still inserted when double-precision results are stored into single-precision memory locations. However, if optimization removes such a store operation, **hssngl** also removes the corresponding rounding operation, possibly preventing the exception. (Depending on the characteristics of your program, you may or may not care whether the exception happens.)

The **hssngl** suboption is safe for all types of programs because it always only *increases* the precision of floating-point calculations. Program results may differ because of the increased precision and because of avoidance of some exceptions.

Detecting and trapping floating-point exceptions

The IEEE standard for floating-point arithmetic defines a number of exception (or error) conditions that might require special care to avoid or recover from. The following topics are intended to help you make your programs work safely in the presence of such exception conditions while sacrificing the minimum amount of performance.

The floating-point hardware always detects a number of floating-point exception conditions (which the IEEE standard rigorously defines): overflow, underflow, zerodivide, invalid, and inexact.

By default, the only action that occurs is that a status flag is set. The program continues without a problem (although the results from that point on may not be what you expect). If you want to know when an exception occurs, you can arrange for one or more of these exception conditions to generate a signal.

The signal causes a branch to a handler routine. The handler receives information about the type of signal and the state of the program when the signal occurred. It can produce a core dump, display a listing showing where the exception occurred, modify the results of the calculation, or carry out some other processing that you specify.

The XL Fortran compiler uses the operating system facilities for working with floating-point exception conditions. These facilities indicate the presence of floating-point exceptions by generating **SIGFPE** signals.

Compiler features for trapping floating-point exceptions

To turn on XL Fortran exception trapping, compile the program with the **-qflttrap** option and some combination of suboptions that includes **enable**. This option uses trap operations to detect floating-point exceptions and generates **SIGFPE** signals when exceptions occur, provided that a signal handler for **SIGFPE** is installed.

-qflttrap also has suboptions that correspond to the names of the exception conditions. For example, if you are only concerned with handling overflow and underflow exceptions, you can specify a command similar to the following one:

```
xlf95 -qfltrap=overflow:underflow:enable compute_pi.f
```

You only need **enable** when you are compiling the main program. However, it is very important then and does not cause any problems if you specify it for other files, so always include it when you use **-qfltrap**.

An advantage of this approach is that performance impact is relatively low. However, this approach only traps exceptions that occur in code that you compiled with **-qfltrap**, which does not include system library routines.

Notes:

1. If your program depends on floating-point exceptions occurring for particular operations, also specify **-qfloat** suboptions that include **nofold**. Otherwise, the compiler might replace an exception-producing calculation with a constant NaN or infinity value, or it might eliminate an overflow in a single-precision operation.
2. The suboptions of the **-qfltrap** option replace an earlier technique that required you to modify your code with calls to the **fpsets** and **fpgets** procedures. You no longer require these calls for exception handling if you use the appropriate **-qfltrap** settings.

Attention: If your code contains **fpsets** calls that enable checking for floating-point exceptions and you do not use the **-qfltrap** option when compiling the whole program, the program will produce unexpected results if exceptions occur, as explained in Table 32 on page 300.

Installing an exception handler

When a program that uses the XL Fortran or Linux exception-detection facilities encounters an exception condition, it receives a signal from the operating system. This causes a branch to whatever handler is specified by the program.

By default, programs on Linux do not trap on floating-point exceptions unless a signal handler is installed. To produce a core file, you can use the **xl__trcedump** signal handler described below. If you want to install a **SIGTRAP** or **SIGFPE** signal handler, use the **-qsigtrap** option. It allows you to specify an XL Fortran handler that produces a traceback or to specify a handler you have written:

```
xlf95 -qfltrap=ov:und:en pi.f # Dump core on an exception
xlf95 -qfltrap=ov:und:en -qsigtrap pi.f # Uses the xl__trce handler
xlf95 -qfltrap=ov:und:en -qsigtrap=return_22_over_7 pi.f # Uses any other handler
```

You can also install an alternative exception handler, either one supplied by XL Fortran or one you have written yourself, by calling the **SIGNAL** subroutine (defined in `/opt/ibm/xlf/15.1.0/include/fexcp.h`):

```
INCLUDE 'fexcp.h'
CALL SIGNAL(SIGTRAP,handler_name)
CALL SIGNAL(SIGFPE,handler_name)
```

The XL Fortran exception handlers and related routines are:

xl__ieee

Produces a traceback and an explanation of the signal and continues execution by supplying the default IEEE result for the failed computation. This handler allows the program to produce the same results as if exception detection was not turned on.

xl__trce

Produces a traceback and stops the program.

xl__trcedump

Produces a traceback and a core file and stops the program.

xl__sigdump

Provides a traceback that starts from the point at which it is called and provides information about the signal. You can only call it from inside a user-written signal handler. It does not stop the program. To successfully continue, the signal handler must perform some cleanup after calling this subprogram.

xl__trbk

Provides a traceback that starts from the point at which it is called. You call it as a subroutine from your code, rather than specifying it with the **-qsigtrap** option. It requires no parameters. It does not stop the program.

All of these handler names contain double underscores to avoid duplicating names that you declared in your program. All of these routines work for both **SIGTRAP** and **SIGFPE** signals.

You can use the **-g** compiler option to get line numbers in the traceback listings. The file `/opt/ibm/xlf/15.1.0/include/fsignal.h` defines a Fortran derived type similar to the `ucontext_t` structure in `/usr/include/sys/ucontext.h` system header. You can write a Fortran signal handler that accesses this derived type.

“Sample programs for exception handling” on page 311 lists some sample programs that illustrate how to use these signal handlers or write your own. Also see the **SIGNAL** procedure in the *XL Fortran Language Reference* for more information.

Producing a core file

To produce a core file, specify the `xl__trcedump` handler.

Controlling the floating-point status and control register

Before the introduction of **-qflttrap** suboptions or the **-qsigtrap** options, most of the processing for floating-point exceptions required you to change your source files to turn on exception trapping or install a signal handler. Although you can still do so, for any new applications, we recommend that you use the options instead.

To control exception handling at run time, compile without the **enable** suboption of the **-qflttrap** option:

```
xl f95 -qflttrap compute_pi.f      # Check all exceptions, but do not trap.
xl f95 -qflttrap=ov compute_pi.f  # Check one type, but do not trap.
```

Then, inside your program, manipulate the **fpstats** array (defined in the include file `/opt/ibm/xlf/15.1.0/include/fpdc.h`) and call the **fpsets** subroutine to specify which exceptions should generate traps.

See the sample program that uses **fpsets** and **fpgets** in “Selecting the rounding mode” on page 302.

Another method is to use the **set_fpscr_flags()** subroutine in the `xl_fpu_util` module. This subroutine allows you to set the floating-point status and control register flags you specify in the **MASK** argument. Flags that you do not specify in **MASK** remain unaffected. **MASK** must be of type **INTEGER(FPSCR_KIND)**. For example:

```

USE, INTRINSIC :: xlf_fp_util
INTEGER(FPSCR_KIND) SAVED_FPSCR
INTEGER(FP_MODE_KIND) FP_MODE

SAVED_FPSCR = get_fpscr()           ! Saves the current value of
                                   ! the fpscr register.

CALL set_fpscr_flags(TRP_DIV_BY_ZERO) ! Enables trapping of
! ...                               ! divide-by-zero.
SAVED_FPSCR=set_fpscr(SAVED_FPSCR)  ! Restores fpscr register.

```

Another method is to use the **ieee_set_halting_mode** subroutine in the **ieee_exceptions** module. This portable subroutine allows you to set the halting (trapping) status for any **FPSCR** exception flags. For example:

```

USE, INTRINSIC :: ieee_exceptions
TYPE(IEEE_STATUS_TYPE) SAVED_FPSCR
CALL ieee_get_status(SAVED_FPSCR)  ! Saves the current value of the
                                   ! fpscr register

CALL ieee_set_halting_mode(IEEE_DIVIDE_BY_ZERO, .TRUE.) ! Enabled trapping
! ...                                                    ! of divide-by-zero.

CALL IEEE_SET_STATUS(SAVED_FPSCR)  ! Restore fpscr register

```

xlf_fp_util procedures

The **xlf_fp_util** procedures allow you to query and control the floating-point status and control register (fpscr) of the processor directly. These procedures are more efficient than the **fpsets** and **fpgets** subroutines because they are mapped into inlined machine instructions that manipulate the floating-point status and control register directly.

The intrinsic module, **xlf_fp_util**, contains the interfaces and data type definitions for these procedures and the definitions for the named constants that are needed by the procedures. This module enables type checking of these procedures at compile time rather than link time. The following files are supplied for the **xlf_fp_util** module:

File names	File type	Locations
xlf_fp_util.mod	module symbol file	/opt/ibm/xlf/15.1.0/include

To use the procedures, you must add a **USE XLF_FP_UTIL** statement to your source file. For more information, see the **USE** statement in the *XL Fortran Language Reference*.

When compiling with the **-U** option, you must code the names of these procedures in all lowercase.

For a list of the **xlf_fp_util** procedures, see the *Service and utility procedures* section in the *XL Fortran Language Reference*.

fpgets and fpsets subroutines

The **fpsets** and **fpgets** subroutines provide a way to manipulate or query the floating-point status and control register. Instead of calling the operating system routines directly, you pass information back and forth in **fpstat**, an array of logicals. The following table shows the most commonly used array elements that deal with exceptions:

Table 34. Exception bits to use with *fpsets* and *fpgets*

Array Element to Set to Enable	Array Element to Check if Exception Occurred	Exception Indicated When <code>.TRUE.</code>
n/a	<code>fpstat(fpf)</code>	Floating-point exception summary
n/a	<code>fpstat(fpfex)</code>	Floating-point enabled exception summary
<code>fpstat(fpve)</code>	<code>fpstat(fpvx)</code>	Floating-point invalid operation exception summary
<code>fpstat(fpoe)</code>	<code>fpstat(fpox)</code>	Floating-point overflow exception
<code>fpstat(fpue)</code>	<code>fpstat(fpux)</code>	Floating-point underflow exception
<code>fpstat(fpze)</code>	<code>fpstat(fpzx)</code>	Zero-divide exception
<code>fpstat(fpxe)</code>	<code>fpstat(fpxx)</code>	Inexact exception
<code>fpstat(fpve)</code>	<code>fpstat(fpvxsnan)</code>	Floating-point invalid operation exception (signaling NaN)
<code>fpstat(fpve)</code>	<code>fpstat(fpvxisi)</code>	Floating-point invalid operation exception (INF-INF)
<code>fpstat(fpve)</code>	<code>fpstat(fpvxidi)</code>	Floating-point invalid operation exception (INF/INF)
<code>fpstat(fpve)</code>	<code>fpstat(fpvxzdz)</code>	Floating-point invalid operation exception (0/0)
<code>fpstat(fpve)</code>	<code>fpstat(fpvximz)</code>	Floating-point invalid operation exception (INF*0)
<code>fpstat(fpve)</code>	<code>fpstat(fpvxvc)</code>	Floating-point invalid operation exception (invalid compare)
n/a	<code>fpstat(fpvxsoft)</code>	Floating-point invalid operation exception (software request), PowerPC only
n/a	<code>fpstat(fpvxsqrt)</code>	Floating-point invalid operation exception (invalid square root), PowerPC only
n/a	<code>fpstat(fpvx cvi)</code>	Floating-point invalid operation exception (invalid integer convert), PowerPC only

To explicitly check for specific exceptions at particular points in a program, use **fpgets** and then test whether the elements in **fpstat** have changed. Once an exception has occurred, the corresponding exception bit (second column in the preceding table) is set until it is explicitly reset, except for **fpstat(fpf)**, **fpstat(fpvx)**, and **fpstat(fpfex)**, which are reset only when the specific exception bits are reset.

An advantage of using the **fpgets** and **fpsets** subroutines (as opposed to controlling everything with suboptions of the **-qfltrap** option) includes control over granularity of exception checking. For example, you might only want to test if an exception occurred anywhere in the program when the program ends.

The disadvantages of this approach include the following:

- You have to change your source code.
- These routines differ from what you may be accustomed to on other platforms.

For example, to trap floating-point overflow exceptions but only in a certain section of the program, you would set `fpstat(fpoe)` to `.TRUE.` and call `fpsets`. After the exception occurs, the corresponding exception bit, `fpstat(fpox)`, is `.TRUE.` until the program runs:

```
call fpgets(fpstat)
fpstat(fpox) = .FALSE.
call fpsets(fpstat) ! resetting fpstat(fpox) to .FALSE.
```

Sample programs for exception handling

Sample programs contained in `/opt/ibm/xlf/15.1.0/samples/floating_point` illustrate different aspects of exception handling:

`flttrap_handler.c` and `flttrap_test.f`

A sample exception handler that is written in C and a Fortran program that uses it.

`xl_ieee.F` and `xl_ieee.c`

Exception handlers that are written in Fortran and C that show how to substitute particular values for operations that produce exceptions. Even when you use support code such as this, the implementation of XL Fortran exception handling does not fully support the exception-handling environment that is suggested by the IEEE floating-point standard.

`check_fpscr.f` and `postmortem.f`

Show how to work with the `fpsets` and `fpgets` procedures and the `fpstats` array.

`fhandler.F`

Shows a sample Fortran signal handler and demonstrates the `xl_sigdump` procedure.

`xl_trbk_test.f`

Shows how to use the `xl_trbk` procedure to generate a traceback listing without stopping the program.

The sample programs are strictly for illustrative purposes only.

Causing exceptions for particular variables

To mark a **REAL** variable as “do not use”, you can encode a special value called a signaling NaN in it. This causes an invalid exception condition any time that variable is used in a calculation.

If you use this technique, use the `nans` suboption of the `-qfloat` option and the `-qstrict` or `-qstrict=nans` option, so that the program properly detects all cases where a signaling NaN is used, and one of the methods already described to generate corresponding **SIGFPE** signals.

Minimizing the performance impact of floating-point exception trapping

If you need to deal with floating-point exception conditions but are concerned that doing so will make your program too slow, here are some techniques that can help minimize the performance impact:

- Consider using only a subset of the **overflow**, **underflow**, **zerodivide**, **invalid**, and **inexact** suboptions with the `-qflttrap` option if you can identify some conditions that will never happen or you do not care about. In particular, because an **inexact** exception occurs for each rounding error, you probably should not check for it if performance is important.

Chapter 12. Porting programs to XL Fortran

XL Fortran provides many features intended to make it easier to take programs that were originally written for other computer systems or compilers and recompile them with XL Fortran.

Outline of the porting process

To port a typical program, you need to identify the nonportable features, modify the source files to remove or work around these features, and compile the program with XL Fortran so you can compare the output with the output from the other system.

The process for porting a typical program looks like this:

1. Identify any nonportable language extensions or features that you used in the original program. Check to see if any of them are supported by XL Fortran:
 - Language extensions are identified in the *XL Fortran Language Reference*.
 - Some extensions require you to specify an XL Fortran compiler option; you can find these options listed in the *Portability and migration options* table in the *XL Fortran Compiler Reference*.
2. For any nonportable features that XL Fortran does not support, modify the source files to remove or work around them.
3. Do the same for any implementation-dependent features. For example, if your program relies on exact bit-pattern representation of floating-point values or uses system-specific file names, you may need to change it.
4. Compile the program with XL Fortran. If any compilation problems occur, fix them and recompile and fix any additional errors until the program compiles successfully.
5. Run the XL Fortran-compiled program and compare the output with the output from the other system. If the results are substantially different, there are probably still some implementation-specific features that need to be changed. If the results are only marginally different (for example, if XL Fortran produces a different number of digits of precision or a number differs in the last decimal place), decide whether the difference is significant enough to investigate further. You might be able to fix these differences.

Before porting programs to XL Fortran, read the tips in the following sections so that you know in advance what compatibility features XL Fortran offers.

Portability of directives

XL Fortran supports many directives available with other Fortran products. This ensures easy portability between products.

If your code contains *trigger_constants* other than the defaults in XL Fortran, you can use the **-qdirective** compiler option to specify them. For instance, if you are porting CRAY code contained in a file *xx.f*, you would use the following command to add the CRAY *trigger_constant*:

```
xlf95 xx.f -qdirective=mic\
```

For fixed source form code, in addition to the ! value for the *trigger_head* portion of the directive, XL Fortran also supports the *trigger_head* values **C**, **c**, and *****.

For more information, see the **-qdirective** option in the *XL Fortran Compiler Reference*.

XL Fortran supports a number of programming terms as synonyms to ease the effort of porting code from other Fortran products. Those terms that are supported are dependent on context, as indicated in the following tables:

Table 35. PARALLEL DO Clauses and their XL Fortran synonyms

PARALLEL DO Clause	XL Fortran Synonym
LASTLOCAL	LASTPRIVATE
LOCAL	PRIVATE
MP_SCHEDTYPE and CHUNK	SCHEDULE
SAVELAST	LASTPRIVATE
SHARE	SHARED
NEW	PRIVATE

Table 36. PARALLEL DO scheduling types and their XL Fortran synonyms

Scheduling Type	XL Fortran Synonym
GSS	GUIDED
INTERLEAVE	STATIC(1)
INTERLEAVED	STATIC(1)
INTERLEAVE(n)	STATIC(n)
INTERLEAVED(n)	STATIC(n)
SIMPLE	STATIC

Table 37. PARALLEL SECTIONS clauses and their XL Fortran synonyms

PARALLEL SECTIONS Clause	XL Fortran Synonym
LOCAL	PRIVATE
SHARE	SHARED
NEW	PRIVATE

Common industry extensions that XL Fortran supports

XL Fortran allows many of the same FORTRAN 77 extensions as other popular compilers.

These extensions include:

Extension	Refer to <i>XL Fortran Language Reference</i> Section(s)
Typeless constants	Typeless literal constants

Extension	Refer to <i>XL Fortran Language Reference</i> Section(s)
<i>*len</i> length specifiers for types	Data types
BYTE data type	Byte
Long variable names	Names
Lower case	Names
Mixing integers and logicals (with -qintlog option)	Evaluation of expressions
Character-count Q edit descriptor (with -qqcount option)	Q (Character Count) Editing
Intrinsics for counting set bits in registers and determining data-object parity	POPCNT, POPPAR
64-bit data types (INTEGER(8) , REAL(8) , COMPLEX(8) , and LOGICAL(8)), including support for default 64-bit types (with -qintsize and -qrealize options)	Integer Real Complex Logical
Integer POINTERS , similar to those supported by CRAY and Sun compilers. (XL Fortran integer pointer arithmetic uses increments of one byte, while the increment on CRAY computers is eight bytes. You may need to multiply pointer increments and decrements by eight to make programs ported from CRAY computers work properly.)	POINTER(integer)
Conditional vector merge (CVMGx) intrinsic functions	CVMGx (TSOURCE, FSOURCE, MASK)
Date and time service and utility functions (<i>rtc</i> , <i>irtc</i> , <i>jdate</i> , <i>clock_</i> , <i>timef</i> , and <i>date</i>)	Service and utility procedures
STRUCTURE , UNION , and MAP constructs	Structure components, Union and map

Finding nonstandard extensions

XL Fortran supports a number of extensions to various language standards. Many of these extensions are so common that you need to keep in mind, when you port programs to other systems, that not all compilers have them. To find such extensions in your XL Fortran programs before beginning a porting effort, use the **-qlanglvl** option:

```
$ # -qnoobject stops the compiler after parsing all the source,
$ # giving a fast way to check for errors.
$ # Look for anything above the base F77 standard.
$ xlf -qnoobject -qlanglvl=77std f77prog.f
...
$ # Look for anything above the F90 standard.
$ xlf90 -qnoobject -qlanglvl=90std use_in_2000.f
...
$ # Look for anything above the F95 standard.
$ xlf95 -qnoobject -qlanglvl=95std use_in_2000.f
...
```

Related reference:



See **-langlvl** in the Compiler Reference



See **-qport** in the Compiler Reference

Mixing data types in statements

The `-qctyp1ss` option lets you use character constant expressions in the same places that you use typeless constants. The `-qintlog` option lets you use integer expressions where you can use logicals, and vice versa. A kind type parameter must not be replaced with a logical constant even if `-qintlog` is on, nor by a character constant even if `-qctyp1ss` is on, nor can it be a typeless constant.

Date and time routines

Date and time routines, such as `dtime`, `etime`, and `jdate`, are accessible as Fortran subroutines.

Other libc routines

A number of other popular routines from the `libc` library, such as `flush`, `getenv`, and `system`, are also accessible as Fortran subroutines.

Changing the default sizes of data types

For porting from machines with larger or smaller word sizes, the `-qintsize` option lets you specify the default size for integers and logicals. The `-qrealsize` option lets you specify the default size for reals and complex components.

Name conflicts between your procedures and XL Fortran intrinsic procedures

If you have procedures with the same names as any XL Fortran intrinsic procedures, the program calls the intrinsic procedure. This situation is more likely with the addition of the many new Fortran 90, Fortran 95, Fortran 2003, and Fortran 2008 intrinsic procedures.

If you still want to call your procedure, add explicit interfaces, `EXTERNAL` statements, or `PROCEDURE` statements for any procedures with conflicting names, or use the `-qextern` option when compiling.

Reproducing results from other systems

XL Fortran provides settings through the `-qfloat` option that help make floating-point results consistent with those from other IEEE systems; this subject is discussed in “Duplicating the floating-point results of other systems” on page 305.

Chapter 13. Vector element order toggling

To consistently use the instructions generated by vector intrinsic procedures, users need to make all existing Vector Multimedia Extension (VMX) and Vector Scalar Extension (VSX) load and store intrinsic procedures operate on the vectors in registers in the same vector element order, either little endian or big endian element order.

Vector element order

The `-qaltivec` option affects the vector element order only in registers when the vectors are operated by a specific set of functions. In registers, the vector layout differs when the computer loads the vector in either big endian element order or little endian element order.

Big endian element order

Vectors are laid out in vector registers from left to right, so that element 0 is the leftmost element in the register.

Little endian element order

Vectors are laid out in vector registers from right to left, so that element 0 is the rightmost element in the register.

For more information, see “Example: Vector layout in the memory and register” on page 318.

Rules for vector element order toggling

The vector element order is toggled in registers by following these rules:

- The `-qaltivec` option does not affect the vector element order in memory, where the vector elements are always stored in big endian element order.
For example, in memory, the vector initialization is not affected by the `-qaltivec` option. The vectors initialized by the EQUIVALENCE statement with the non-vectors (such as arrays) are always in big endian element order in memory. When the initialized vector is loaded to registers, the vector element order is always reversed to little endian element order in registers even when `-qaltivec=be`. However, if the vector loading is realized by using the vector intrinsic procedure, the vector element order is arranged with respect to the `-qaltivec` option.
- When `-qaltivec=le` is in effect, the behaviours of procedures are as follows:
 - The VMX and VSX load intrinsic procedures load vectors to registers in little endian element order.
 - The VMX and VSX store intrinsic procedures assume that the vectors to be stored are in little endian element order in registers.
 - The nonload and nonstore intrinsic procedures assume that vectors are loaded in registers in little endian element order.
- When `-qaltivec=be` is in effect, these procedures operate on the vectors in an opposite way of `-qaltivec=le`. The vectors in registers are in big endian element order.

- Regardless of the `-qaltivec` option, the `VEC_XL_BE` procedure loads vectors to registers always in big endian element order and the `VEC_XST_BE` procedure assumes that vectors to be stored are always in big endian element order in registers.

For more information, see “Example: The vector intrinsic procedure affected by the `-qaltivec` option” on page 319 and “Example: The vector initialization by using the `EQUIVALENCE` statement with arrays” on page 319.

Example: Vector layout in the memory and register

The following example gets the first element of vector `va` by calling the `VEC_EXTRACT` procedure. The procedure returning value is different based on the `-qaltivec` option that determines whether `VEC_EXTRACT` arranges the vector elements in big endian or little endian element order.

```
INTEGER(4) FUNCTION get_first_element(va)
  VECTOR(INTEGER(4)) va

  !vec_extract is affected by the -qaltivec option
  get_first_element = VEC_EXTRACT(va, 0)

END FUNCTION
```

The following tables show the vector layout in the memory and the register.

Table 38. Vector layout in the memory

Vector element value	E0	E1	E2	E3
----------------------	----	----	----	----

- When `-qaltivec=be`, the vector elements are loaded to registers in big endian element order and vector layout looks as follows.

Table 39. Vector layout in big endian element order

Vector element number	0	1	2	3
Vector element value	E0	E1	E2	E3

The elements of vector `va` are ordered from the first to last, and stored from the left of registers. The `get_first_element` procedure gets the first element `E0` from the left of registers.

- When `-qaltivec=le`, the vector elements are loaded to registers in little endian element order and vector layout looks as follows.

Table 40. Vector layout in little endian element order

Vector element number	3	2	1	0
Vector element value	E3	E2	E1	E0

The elements of vector `va` are ordered from the last to first, and also stored from the left of registers. The `get_first_element` procedure gets the first element `E0` from the right of registers.

Example: The vector intrinsic procedure affected by the `-qaltivec` option

The following program example `vec_xlw4.f` shows that the `VEC_XLW4` procedure loads the vector elements in registers in the order specified by the `-qaltivec` option. The `VEC_EXTRACT` procedure recognizes the element order because it is affected by the `-qaltivec` option as well. Therefore, the same output is obtained with `-qaltivec=be` and `-qaltivec=le`.

```
PROGRAM main

  IMPLICIT NONE

  VECTOR(INTEGER(4)) a4
  INTEGER(4) c4(4)
  INTEGER i

  c4 = [0, 1, 2, 3]

  !VEC_XLW4 is affected by the -qaltivec option
  a4 = VEC_XLW4(0, c4)

  !VEC_EXTRACT is affected by the -qaltivec option
  PRINT *, (VEC_EXTRACT(a4, i), i=0, 3)

END
```

- Compile the program with `-qaltivec=le` by running the following command:

```
xlf95 vec_xlw4.f -qaltivec=le
```

Output:

```
0 1 2 3
```

- Compile the program with `-qaltivec=be` by running the following command:

```
xlf95 vec_xlw4.f -qaltivec=be
```

The compilation result is the same as that of output generated by using `-qaltivec=le`.

Example: The vector initialization by using the `EQUIVALENCE` statement with arrays

The following program example `vec_equiv.f` contains the vectors initialization by using the `EQUIVALENCE` statement with arrays. The vector loading is not affected by the `-qaltivec` option and the vector is loaded to registers in little endian element order. The `VEC_EXTRACT` procedure is affected by the `-qaltivec=be` option. Therefore, the program compilation output is difference between `-qaltivec=be` and `-qaltivec=le`.

```
PROGRAM main

  IMPLICIT NONE

  VECTOR(INTEGER(4)) a4
  INTEGER(4) c4(4)
  INTEGER i

  EQUIVALENCE(a4, c4)
  !In the memory, the vector initialization (by using equivalence)
  !is not affected by the -qaltivec option and
  !the vector is store in big endian element order.
  !The initialized vector is loaded in registers by
  !being reversed to the little endian element order.

  c4 = [0, 1, 2, 3]
```

```
!vec_extract is affected by the -qaltivec option
PRINT *, (VEC_EXTRACT(a4, i), i=0, 3)
```

END

- Compile the codes with `-qaltivec=le` by running the following command:

```
xlf95 vec_equiv.f -qaltivec=le
```

Output:

```
0 1 2 3
```

- Compile the program with `-qaltivec=be` by running the following command:

```
xlf95 vec_equiv.f -qaltivec=be
```

Output:

```
3 2 1 0
```

The compilation result is different from that of compilation with `-qaltivec=le`.

Related information:



`-qaltivec`



EQUIVALENCE

Program migration from big endian systems

When migrating the programs that contain the Vector Multimedia Extension (VMX) and Vector Scalar Extension (VSX) intrinsic procedures from big endian systems, you can use `-qaltivec=be` to minimize program changes, but you need to pay attention in specific cases.

The following table shows what users need to pay attention when migrating code from big endian systems by using `-qaltivec=be`.

Table 41. Attention when -qaltivec=be

Case	Attention
If the existing program contains only VMX load and store intrinsic procedures	Using <code>-qaltivec=be</code> may affect the program performance; using <code>-qaltivec=le</code> may affect the performance in different ways.
If the existing program contains only VSX load and store intrinsic procedures	In the existing programs, you can use the <code>VEC_XL</code> and <code>VEC_XST</code> procedures to replace the VSX load and store intrinsic procedures to maximally simplify the code changes.
If the existing program contains both VMX and VSX load and store intrinsic procedures	You need to pay attention to the differences of the element order of vectors that are operated by the VMX and VSX intrinsic procedures in little endian systems.
If the existing program contains the vector initialization by using the EQUIVALENCE statement with arrays	You need to use the <code>VEC_LD</code> or <code>VEC_XL</code> procedure to load the vectors explicitly, instead of using the EQUIVALENCE with arrays, or you can reverse the element order of the array used for vector initialization.

Related information:



`-qaltivec`



Vector intrinsic procedures (IBM extension)

Chapter 14. Sample Fortran programs

The programs in the topics referenced here are provided as coding examples for XL Fortran.

A number of these samples illustrate various aspects of SMP programming that may be new to many users. If you are new to SMP programming, you should examine these samples to gain a better understanding of the SMP coding style.

You can compile and execute the first program to verify that the compiler is installed correctly and your user ID is set up to execute Fortran programs.

Example 1 - XL Fortran source file

This is an example of an XL Fortran source file

```
PROGRAM CALCULATE
!
! Program to calculate the sum of up to n values of x**3
! where negative values are ignored.
!
  IMPLICIT NONE
  INTEGER I,N
  REAL SUM,X,Y
  READ(*,*) N
  WRITE(*,*) N
  SUM=0
  DO I=1,N
    READ(*,*) X
    WRITE(*,*) X
    IF (X.GE.0.0) THEN
      Y=X**3
      SUM=SUM+Y
    END IF
  END DO
  WRITE(*,*) 'This is the sum of the positive cubes:',SUM
END
```

Execution results

Running the program yields the following results:

```
$ a.out
5
37
22
-4
19
6
  This is the sum of the positive cubes: 68376.00000
```

Example 2 - valid C routine source file

This is an example of a valid C routine source file used to execute Fortran test subroutines.

```
/*
 * *****
 * This is a main function that creates threads to execute the Fortran
 * test subroutines.
```

```

* ****
*/
#include <pthread.h>
#include <stdio.h>
#include <errno.h>

extern char *optarg;
extern int optind;

static char *prog_name;

#define MAX_NUM_THREADS 100

void *f_mt_exec(void *);
void f_pre_mt_exec(void);
void f_post_mt_exec(int *);

void
usage(void)
{
    fprintf(stderr, "Usage: %s -t number_of_threads.\n", prog_name);
    exit(-1);
}

main(int argc, char *argv[])
{
    int i, c, rc;
    int num_of_threads, n[MAX_NUM_THREADS];
    char *num_of_threads_p;
    pthread_attr_t attr;
    pthread_t tid[MAX_NUM_THREADS];

    prog_name = argv[0];
    while ((c = getopt(argc, argv, "t")) != EOF)
    {
        switch (c)
        {
            case 't':
                break;

            default:
                usage();
                break;
        }
    }

    argc -= optind;
    argv += optind;
    if (argc < 1)
    {
        usage();
    }

    num_of_threads_p = argv[0];
    if ((num_of_threads = atoi(num_of_threads_p)) == 0)
    {
        fprintf(stderr,
            "%s: Invalid number of threads to be created <\n", prog_name,
            num_of_threads_p);
        exit(1);
    }
    else if (num_of_threads > MAX_NUM_THREADS)
    {
        fprintf(stderr,
            "%s: Cannot create more than 100 threads.\n", prog_name);
        exit(1);
    }
}

```

```

pthread_attr_init(&attr);
pthread_attr_setdetachstate(&attr, PTHREAD_CREATE_JOINABLE);

/* *****
 * Execute the Fortran subroutine that prepares for multithreaded
 * execution.
 * *****
 */
f_pre_mt_exec();

for (i = 0; i < num_of_threads; i++)
{
    n[i] = i;
    rc = pthread_create(&tid[i], &attr, f_mt_exec, (void *)&n[i]);
    if (rc != 0)
    {
        fprintf(stderr, "Failed to create thread %d.\n", i);

        exit(1);
    }
}
/* The attribute is no longer needed after threads are created. */
pthread_attr_destroy(&attr);
for (i = 0; i < num_of_threads; i++)
{
    rc = pthread_join(tid[i], NULL);
    if (rc != 0)
    {
        fprintf(stderr, "Failed to join thread %d. \n", i);
    }
}
/*
 * Execute the Fortran subroutine that does the check after
 * multithreaded execution.
 */
f_post_mt_exec(&num_of_threads);

exit(0);
}

! *****
! This test case tests the writing list-directed to a single external
! file by many threads.
! *****

subroutine f_pre_mt_exec()
integer array(1000)
common /x/ array

do i = 1, 1000
    array(i) = i
end do

open(10, file="fun10.out", form="formatted", status="replace")
end

subroutine f_post_mt_exec(number_of_threads)
integer array(1000), array1(1000)
common /x/ array

close(10)
open(10, file="fun10.out", form="formatted")
do j = 1, number_of_threads
    read(10, *) array1

do i = 1, 1000

```

```

        if (array1(i) /= array(i)) then
            print *, "Result is wrong."
            stop
        endif
    end do
end do
close(10, status="delete")
print *, "Normal ending."
end

subroutine f_mt_exec(thread_number)
integer thread_number
integer array(1000)
common /x/ array

write(10, *) array
end

```

Example 3 - valid Fortran SMP source file

This is an example of a valid Fortran SMP source file used to calculate the value of pi.

```

!*****
!* This example uses a PARALLEL construct and a DO construct *
!* to calculate the value of pi. *
!*****
program compute_pi
integer n, i
real*8 w, x, pi, f, a
f(a) = 4.d0 / (1.d0 + a*a) !! function to integrate

pi = 0.0d0
!$OMP PARALLEL private(x, w, n), shared(pi)
n = 10000 !! number of intervals
w = 1.0d0/n !! calculate the interval size
!$OMP DO reduction(+: pi)
do i = 1, n
x = w * (i - 0.5d0)
pi = pi + f(x)
enddo
!$OMP END DO
!$OMP END PARALLEL
print *, "Computed pi = ", pi
end

```

Example 4 - invalid Fortran SMP source file

This is an example of an invalid Fortran SMP source file.

```

!*****
!* In this example, fort_sub is invoked by multiple threads. *
!* * *
!* This example is not valid because *
!* fort_sub and another_sub both declare /block/ to be *
!* THREADPRIVATE. They intend to share the common block, but *
!* they are executed via different threads. *
!* * *
!* To "fix" this problem, one of the following approaches can *
!* be taken: *
!* (1) The code for another_sub should be brought into the loop.*
!* (2) "j" should be passed as an argument to another_sub, and *
!* the declaration for /block/ should be removed from *
!* another_sub. *
!* (3) The loop should be marked as "do not parallelize" by *
!* using the directive "!$OMP PARALLEL DO IF(.FALSE.)". *

```

```

!*****
subroutine fort_sub()

  common /block/ j
  integer :: j
  !$OMP THREADPRIVATE(/block/)      ! Each thread executing fort_sub
                                     ! obtains its own copy of /block/.

  integer a(10)

  ...
  !$OMP PARALLEL DO
  do index = 1,10
    call another_sub(a(i))
  enddo
  ...

end subroutine fort_sub

subroutine another_sub(aa)           ! Multiple threads are used to
  integer aa                         ! execute another_sub.
  common /block/ j                   ! Each thread obtains a new copy
  integer :: j                       ! of the common block /block/.
  !$OMP THREADPRIVATE(/block/)

  aa = j                             ! The value of "j" is undefined.
end subroutine another_sub

```

Programming examples using the Pthreads Library Module

These examples demonstrate the use of the Pthreads library module.

```

!*****
!* Example 5 : Create a thread with Round_Robin scheduling policy.*
!* For simplicity, we do not show any codes for error checking, *
!* which would be necessary in a real program.                 *
!*****
      use, intrinsic::f_pthread
      integer(4) ret_val
      type(f_pthread_attr_t) attr
      type(f_pthread_t) thr

      ret_val = f_pthread_attr_init(attr)
      ret_val = f_pthread_attr_setschedpolicy(attr, SCHED_RR)
      ret_val = f_pthread_attr_setinheritsched(attr, PTHREAD_EXPLICIT_SCHED)
      ret_val = f_pthread_create(thr, attr, FLAG_DEFAULT, ent, integer_arg)
      ret_val = f_pthread_attr_destroy(attr)
      .....

```

Before you can manipulate a pthread attribute object, you need to create and initialize it. The appropriate interfaces must be called to manipulate the attribute objects. A call to **f_pthread_attr_setschedpolicy** sets the scheduling policy attribute to Round_Robin. Note that this does not affect newly created threads that inherit the scheduling property from the creating thread. For these threads, we explicitly call **f_pthread_attr_setinheritsched** to override the default inheritance attribute. The rest of the code is self-explanatory.

```

!*****
!* Example 6 : Thread safety *
!* In this example, we show that thread safety can be achieved *
!* by using the push-pop cleanup stack for each thread. We *
!* assume that the thread is in deferred cancellability-enabled *
!* state. This means that any thread-cancel requests will be *
!* put on hold until a cancellation point is encountered. *
!* Note that f_pthread_cond_wait provides a *
!* cancellation point. *
!*****

```

```

!*****
use, intrinsic::f_thread
integer(4) ret_val
type(f_thread_mutex_t) mutex
type(f_thread_cond_t) cond
pointer(p, byte)
! Initialize mutex and condition variables before using them.
! For global variables this should be done in a module, so that they
! can be used by all threads. If they are local, other threads
! will not see them. Furthermore, they must be managed carefully
! (for example, destroy them before returning, to avoid dangling and
! undefined objects).
mutex = PTHREAD_MUTEX_INITIALIZER
cond = PTHREAD_COND_INITIALIZER

.....
! Doing something

.....

! This thread needs to allocate some memory area used to
! synchronize with other threads. However, when it waits on a
! condition variable, this thread may be canceled by another
! thread. The allocated memory may be lost if no measures are
! taken in advance. This will cause memory leakage.

ret_val = f_thread_mutex_lock(mutex)
p = malloc(%val(4096))

! Check condition. If it is not true, wait for it.
! This should be a loop.

! Since memory has been allocated, cleanup must be registered
! for safety during condition waiting.

ret_val = f_thread_cleanup_push(mycleanup, FLAG_DEFAULT, p)
ret_val = f_thread_cond_wait(cond, mutex)

! If this thread returns from condition waiting, the cleanup
! should be de-registered.

call f_thread_cleanup_pop(0)      ! not execute
ret_val = f_thread_mutex_unlock(mutex)

! This thread will take care of p for the rest of its life.
.....

! mycleanup looks like:

subroutine mycleanup(passed_in)
  pointer(passed_in, byte)
  external free

  call free(%val(passed_in))
end subroutine mycleanup

```

Notices

Programming interfaces: Intended programming interfaces allow the customer to write programs to obtain the services of IBM XL Fortran for Linux.

This information was developed for products and services offered in the U.S.A. IBM may not offer the products, services, or features discussed in this document in other countries. Consult your local IBM representative for information on the products and services currently available in your area. Any reference to an IBM product, program, or service is not intended to state or imply that only that IBM product, program, or service may be used. Any functionally equivalent product, program, or service that does not infringe any IBM intellectual property right may be used instead. However, it is the user's responsibility to evaluate and verify the operation of any non-IBM product, program, or service.

IBM may have patents or pending patent applications covering subject matter described in this document. The furnishing of this document does not give you any license to these patents. You can send license inquiries, in writing, to:

IBM Director of Licensing
IBM Corporation
North Castle Drive, MD-NC119
Armonk, NY 10504-1785
U.S.A.

For license inquiries regarding double-byte (DBCS) information, contact the IBM Intellectual Property Department in your country or send inquiries, in writing, to:

Intellectual Property Licensing
Legal and Intellectual Property Law
IBM Japan, Ltd.
19-21, Nihonbashi-Hakozakicho, Chuo-ku
Tokyo 103-8510, Japan

The following paragraph does not apply to the United Kingdom or any other country where such provisions are inconsistent with local law:

INTERNATIONAL BUSINESS MACHINES CORPORATION PROVIDES THIS PUBLICATION "AS IS" WITHOUT WARRANTY OF ANY KIND, EITHER EXPRESS OR IMPLIED, INCLUDING, BUT NOT LIMITED TO, THE IMPLIED WARRANTIES OF NON-INFRINGEMENT, MERCHANTABILITY OR FITNESS FOR A PARTICULAR PURPOSE. Some states do not allow disclaimer of express or implied warranties in certain transactions, therefore, this statement may not apply to you.

This information could include technical inaccuracies or typographical errors. Changes are periodically made to the information herein; these changes will be incorporated in new editions of the publication. IBM may make improvements and/or changes in the product(s) and/or the program(s) described in this publication at any time without notice.

Any references in this information to non-IBM websites are provided for convenience only and do not in any manner serve as an endorsement of those

websites. The materials at those websites are not part of the materials for this IBM product and use of those websites is at your own risk.

IBM may use or distribute any of the information you supply in any way it believes appropriate without incurring any obligation to you.

Licenses of this program who want to have information about it for the purpose of enabling: (i) the exchange of information between independently created programs and other programs (including this one) and (ii) the mutual use of the information which has been exchanged, should contact:

Intellectual Property Dept. for Rational Software
IBM Corporation
5 Technology Park Drive
Westford, MA 01886
U.S.A.

Such information may be available, subject to appropriate terms and conditions, including in some cases, payment of a fee.

The licensed program described in this document and all licensed material available for it are provided by IBM under terms of the IBM Customer Agreement, IBM International Program License Agreement or any equivalent agreement between us.

Any performance data contained herein was determined in a controlled environment. Therefore, the results obtained in other operating environments may vary significantly. Some measurements may have been made on development-level systems and there is no guarantee that these measurements will be the same on generally available systems. Furthermore, some measurements may have been estimated through extrapolation. Actual results may vary. Users of this document should verify the applicable data for their specific environment.

Information concerning non-IBM products was obtained from the suppliers of those products, their published announcements or other publicly available sources. IBM has not tested those products and cannot confirm the accuracy of performance, compatibility or any other claims related to non-IBM products. Questions on the capabilities of non-IBM products should be addressed to the suppliers of those products.

All statements regarding IBM's future direction or intent are subject to change or withdrawal without notice, and represent goals and objectives only.

This information contains examples of data and reports used in daily business operations. To illustrate them as completely as possible, the examples include the names of individuals, companies, brands, and products. All of these names are fictitious and any similarity to the names and addresses used by an actual business enterprise is entirely coincidental.

COPYRIGHT LICENSE:

This information contains sample application programs in source language, which illustrates programming techniques on various operating platforms. You may copy, modify, and distribute these sample programs in any form without payment to IBM, for the purposes of developing, using, marketing or distributing application programs conforming to the application programming interface for the operating

platform for which the sample programs are written. These examples have not been thoroughly tested under all conditions. IBM, therefore, cannot guarantee or imply reliability, serviceability, or function of these programs. The sample programs are provided "AS IS", without warranty of any kind. IBM shall not be liable for any damages arising out of your use of the sample programs.

Each copy or any portion of these sample programs or any derivative work, must include a copyright notice as follows:

© (your company name) (year). Portions of this code are derived from IBM Corp. Sample Programs. © Copyright IBM Corp. 1998, 2016.

This software and documentation are based in part on the Fourth Berkeley Software Distribution under license from the Regents of the University of California. We acknowledge the following institution for its role in this product's development: the Electrical Engineering and Computer Sciences Department at the Berkeley campus.

PRIVACY POLICY CONSIDERATIONS:

IBM Software products, including software as a service solutions, ("Software Offerings") may use cookies or other technologies to collect product usage information, to help improve the end user experience, or to tailor interactions with the end user, or for other purposes. In many cases no personally identifiable information is collected by the Software Offerings. Some of our Software Offerings can help enable you to collect personally identifiable information. If this Software Offering uses cookies to collect personally identifiable information, specific information about this offering's use of cookies is set forth below.

This Software Offering does not use cookies or other technologies to collect personally identifiable information.

If the configurations deployed for this Software Offering provide you as customer the ability to collect personally identifiable information from end users via cookies and other technologies, you should seek your own legal advice about any laws applicable to such data collection, including any requirements for notice and consent.

For more information about the use of various technologies, including cookies, for these purposes, see IBM's Privacy Policy at <http://www.ibm.com/privacy> and IBM's Online Privacy Statement at <http://www.ibm.com/privacy/details> in the section entitled "Cookies, Web Beacons and Other Technologies," and the "IBM Software Products and Software-as-a-Service Privacy Statement" at <http://www.ibm.com/software/info/product-privacy>.

Trademarks

IBM, the IBM logo, and [ibm.com](http://www.ibm.com) are trademarks or registered trademarks of International Business Machines Corp., registered in many jurisdictions worldwide. Other product and service names might be trademarks of IBM or other companies. A current list of IBM trademarks is available on the web at "Copyright and trademark information" at <http://www.ibm.com/legal/copytrade.shtml>.

Adobe and the Adobe logo are either registered trademarks or trademarks of Adobe Systems Incorporated in the United States, other countries, or both.

Linux is a registered trademark of Linus Torvalds in the United States, other countries, or both.

Index

A

- advanced optimization
 - overview 4
- aliasing
 - optimization 43
- application characteristics
 - options 38
- arguments
 - languages 263
 - passing
 - reference 267
 - value 267
 - subprogram calls 262
- array initialization
 - code size 48
- arrays
 - languages 266
- assembler
 - linkage conventions 270
- attribute clauses
 - data scope 155
 - discussion 155

B

- basic optimization
 - overview 2
- block
 - cyclic scheduling 177

C

- C preprocessor macros
 - _OPENMP 79
- calls
 - C functions 262
 - interlanguage 259
 - subprograms
 - other languages 262
- CASE construct
 - code size 49
- character data
 - languages 265
 - passing 265
- clauses
 - PROC_BIND 171
- code size
 - array initialization 48
 - blocking 47
 - CASE constructs 49
 - computed GOTOs 49
 - dynamic linking 50
 - high activity areas 49
 - managemnt 47
 - options
 - qcompact 49
 - qhot 49
 - qinline 48
 - page faults 49
 - reduction 48

- code size (*continued*)
 - static linking 50
 - steps 48
- combination
 - work-sharing constructs 101
- common blocks
 - data scope
 - attribute clauses 155
- compiler options
 - qarch 35
 - qcache 37
 - qcompact 49
 - qfunctrace 28
 - qhot 49
 - qtune 36
- compiler-friendly techniques
 - aliasing 57
 - arrays 58
 - choosing appropriate variable sizes 58
 - compiler invocations 57
 - floating-point precision 58
 - PERMUTATION 58
 - pointers 57
 - SUBMODULE 59
 - submodules 59
 - variables 57
 - WHERE constructs 58
- computed GOTO
 - code size 49
- controlling
 - optimization transformations 40
- core file
 - producing 308

D

- data scoping
 - rules 154
- data sharing attribute rules 154
- data types
 - Fortran and C 263
- debugging
 - optimized code 53
- deprecated SMP directive 102
- directives
 - deprecated 102
 - FLUSH 115
 - non-OpenMP SMP 101
 - other OpenMP 101
 - parallelization
 - clauses 155
 - details 102
 - overview 100
 - portability 313
- directories
 - scratch files 287
- double precision
 - values 300
- duplication
 - floating-point 305

- duplication (*continued*)
 - floating-point results 305
- dynamic linking
 - code size 50

E

- enabling
 - MASS 10
 - VMX or VSX 10
- environment variables
 - OpenMP 85
 - runtime
 - XLSMPOPTS 80
 - value 282
 - XLFSRATCH 287
 - XLSMPOPTS 80
- error
 - handling 292
- exception handlers
 - installing 307
- exception handling
 - floating-point 306
 - models 299
- explicit interfaces
 - %REF 268
 - %VAL 268
- extended precision
 - values 301
- external names
 - module procedures 259
 - naming conventions 259

F

- files
 - I/O formats 281
 - names 282
 - permissions 285
 - positioning 284
- floating-point
 - exceptions 306
 - optimization 38
 - processing
 - implementation 297
 - optimization 305
- floating-point exceptions
 - compiler features 306
 - control and status register 308
- floating-point results
 - duplicating 305
- flushing
 - buffers 286
- FORTTRAN 77
 - extensions 314
- fpscr register
 - subroutines 309
- fpstat array
 - subroutines 309

- functions
 - calls 277
 - linkage convention 277
 - return values 269
- FUNCTRACE_XLF_CATCH
 - directives 28
- FUNCTRACE_XLF_ENTER
 - directives 28
- FUNCTRACE_XLF_EXIT
 - directives 28

H

- high-order transformations
 - loops 9
- HOT
 - loops 9
 - short vectorization 10

I

- I/O buffers
 - flushing 286
- IEEE
 - double-precision 298
 - single-precision 298
- IEEE arithmetic
 - overview 297
- implicitly connected files
 - overview 283
- initialization
 - file position 284
- inlining
 - code size 48
 - overview 44
- input/output
 - redirecting 284
 - redirection 284
- installation
 - exception handlers 307
- interaction
 - I/O
 - links 285
- interactionXL Fortran I/O with
 - I/O
 - pipes 285
 - special files 285
- interlanguage calls
 - application 259
 - arguments passing 267
 - arrays 266
 - C++ 261
 - character data 265
 - character types 265
 - data types
 - correspondence 263
 - input and output 260
 - low-level linkage conventions 270
 - passing strings
 - C functions 265
 - pointers 267
- IPA
 - C and C++ 14
 - levels 13
 - processes 7
 - steps 11

- IPA (*continued*)
 - suboptions 13

L

- libmass library 64
- libraries
 - vector 66
- library
 - MASS 63
 - scalar 64
- long vectorization
 - HOT 10
- loops
 - optimization 9

M

- MASS libraries
 - overview 63
 - scalar functions 64
 - SIMD functions 70
 - vector functions 66
- migration
 - code 320
 - other systems 313

N

- names
 - files 282

O

- O0
 - overview 3
- O2
 - overview 3
- O3
 - overview 5
- O4
 - overview 7
- O5
 - overview 8
- OpenMP
 - environment variables
 - OMP_DYNAMIC 87
 - OMP_MAX_ACTIVE_LEVELS 89
 - OMP_NESTED 89
 - OMP_NUM_THREADS 89
 - OMP_PLACES 91
 - OMP_PROC_BIND 92
 - OMP_SCHEDULE 96
 - OMP_STACKSIZE 97
 - OMP_THREAD_LIMIT 98
 - OMP_WAIT_POLICY 99
 - execution environment routines
 - description 180
 - omp_get_dynamic 183
 - omp_get_max_threads 185
 - omp_get_nested 185
 - omp_get_num_places 186
 - omp_get_num_procs 186
 - omp_get_num_threads 187

- OpenMP (*continued*)

- execution environment routines
 - (*continued*)
 - omp_get_partition_num_places 188
 - omp_get_partition_place_nums 188
 - omp_get_place_num 189
 - omp_get_place_num_procs 189
 - omp_get_place_proc_ids 190
 - omp_get_thread_num 192
 - omp_in_final 195
 - omp_in_parallel 195
 - omp_set_dynamic 198
 - omp_set_nested 200
 - omp_set_num_threads 202
- functions
 - omp_get_active_level 183
 - omp_get_ancestor_thread_num 183
 - omp_get_level 184
 - omp_get_max_active_levels 184
 - omp_get_proc_bind 190
 - omp_get_team_size 192
 - omp_get_thread_limit 192
- lock routines
 - description 180
 - omp_destroy_lock 181
 - omp_init_lock 196
 - omp_set_lock 199
 - omp_test_lock 203
 - omp_test_nest_lock 204
 - omp_unset_lock 204
 - omp_unset_nest_lock 205
- nestable lock routines
 - omp_destroy_nest_lock 182
 - omp_init_nest_lock 197
 - omp_set_nest_lock 201
- parallel constructs 100
- schedule routines
 - omp_get_schedule 191
 - omp_set_schedule 202
- subroutines
 - omp_set_max_active_levels 199
- timing routines
 - omp_get_wtick 194
 - omp_get_wtime 194
- optimization
 - application characteristics 38
 - avoiding 42
 - diagnostics 26
 - floating-point arithmetic 305
 - issues
 - debugging 53
 - levels
 - O0 3
 - O2 3
 - O3 5
 - O4 7
 - O5 8
 - loops 38
 - math functions 63
 - options 38, 40, 42
 - debugging 54
 - overview 1
 - results 53
 - techniques 8
 - trade-offs
 - O3 6
 - O4 7

- optimization (*continued*)
 - trade-offs (*continued*)
 - O5 8
 - transformations 40
 - tuning 35
- optimization and tuning
 - optimizing 1
 - tuning 1
- options
 - mtune 36
 - qarch 35
 - qcache 37
 - qcompact 49
 - qfloat 305
 - qfunctrace 28
 - qhot 49
 - qtune 36

P

- parallelization directives
 - categories 100
 - details 102
- parsing
 - compiler reports 28
- passing
 - null-terminated strings
 - C functions 265
- passing arguments
 - reference 267
 - value 267
- performance
 - maximization
 - floating-point arithmetic 305
- performance analysis
 - options 41
- permissions
 - files 285
- portability
 - directives 313
- porting
 - parallelized code 79
 - programs 313
- preconnected files
 - overview 283
- procedures
 - tracing 28
- profile-directed feedback (PDF)
 - cleanpdf 19
 - executable levels 20
 - mergepdf 16
 - object level 21
 - overview 14
 - qpdf1 15
 - recompiling 19
 - showpdf 15
 - standard PDF files 17
 - training 16
- profiling
 - qpdf1 15
 - qpdf2 19
- Pthreads Library Module
 - examples 325
 - functions descriptions 206

R

- REAL variables
 - prevention 311
- record lengths
 - RECL= 285
- representation
 - minus infinity 298
 - negative infinity 298
 - plus infinity 298
 - positive infinity 298
 - quiet NaN 298
 - signaling NaN 298
- rounding
 - errors 304
 - floating-point 302
 - mode
 - consistency 304
 - selecting 302
- routines
 - OpenMP 180
- routines
 - OpenMP 180
- rules
 - data scoping 154
- runtime option
 - unit_vars 287
- runtime options
 - scratch_vars 287

S

- same programs
 - C++ and Fortran 261
- sample programs
 - floating-point exception handling 311
 - Fortran 321
 - C functions 263
 - SMP 321
- scalar MASS library 64
- scope
 - data scope attribute clauses 155
- signal handling
 - floating point 306
- signaling
 - NaN 311
- SIGTRAP signal 306
- SINGLE / END SINGLE
 - directives 137
- single precision
 - values 300
- SMP
 - sample programs 321
- SMP applications
 - developing 100
 - running 100
- stack
 - overview 272
- static linking
 - code size 50
- subprograms
 - calling 259
 - other languages 259
- synchronization
 - constructs 101

T

- thread-safing
 - Pthreads Library Module 206
- trace
 - procedures 28
- tuning
 - avoiding 42
 - optimization transformations 40
 - options 37, 42
 - overview 35
 - performance analysis 41
 - providing your application
 - characteristics 38
 - qarch 35
 - qcache 37
 - qtune 36
 - target architecture 35

V

- values
 - double-precision 300
 - infinity 298
 - minus infinity 298
 - NaN 298
 - negative infinity 298
 - plus infinity 298
 - positive infinity 298
 - quiet NaN 298
 - REAL(16) 301
 - REAL(4) 298
 - REAL(4) and REAL(8) 300
 - REAL(8) 298
 - signaling NaN 298
 - single-precision 300
- vector element orders
 - toggling 317
- vectorization
 - long 10
 - short 10

W

- work-sharing constructs
 - directives 100
 - SECTIONS / END
 - SECTIONS 133
 - SINGLE / END SINGLE 137



Product Number: 5765-J10; 5725-C75

Printed in USA

SC27-6600-03

