



CICS Transaction Server for VSE/ESA

CICS Web Support Technical Overview

The IBM logo, consisting of the letters 'IBM' in a bold, white, sans-serif font, positioned at the bottom of a vertical blue bar on the left side of the slide.

IBM

Chris Smith
smithch@uk.ibm.com

Last Updated: July, 2001

© Copyright IBM Corporation 2001

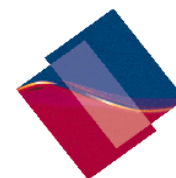

Trademarks



e-business

- The following terms are trademarks of International Business Machines Corporation in the United States and/or other countries:

AIX	DB2	OS/390	VisualAge
CICS	MVS/ESA	VSE/ESA	
CICS/VSE	OS/2	VTAM	

- Java and Solaris are trademarks of Sun Microsystems, Inc
- Windows, Windows 95, Windows 98, Windows 2000, and Windows NT are trademarks of Microsoft Corporation, Inc
- Other company, product, and service names may be trademarks or service marks of others

IBM



Agenda



e-business

- What is CICS Web Support?
- CICS Web Support architecture
- Enabling CICS Web Support
- Writing CICS Web Applications
- Running 3270-based transactions with CICS Web Support
- Further Information and Summary

The IBM logo, consisting of the letters 'IBM' in a bold, sans-serif font, is positioned at the bottom left of the slide.

IBM



Agenda



e-business

- *What is CICS Web Support?*
- CICS Web Support architecture
- Enabling CICS Web Support
- Writing CICS Web Applications
- Running 3270-based transactions with CICS Web Support
- Further Information and Summary

The IBM logo, consisting of the letters 'IBM' in a bold, white, sans-serif font, is positioned at the bottom left of the slide. The background of the slide features a vertical strip on the left with a globe, a mouse, and the text 'e-business' and 'IBM'.

What is CICS Web Support?



e-business

- Set of services that enables direct connection from a Web browser to CICS Transaction Server for VSE/ESA
- Formerly known as the CICS Web Interface
- Enables access to CICS Application Programs and Transactions
- New provided API's for "Web aware" applications
- Delivered in CICS Transaction Server for VSE/ESA V1.1.1

The IBM logo, consisting of the letters 'IBM' in a bold, sans-serif font, is positioned at the bottom left of the slide.

IBM



What is CICS Web Support?

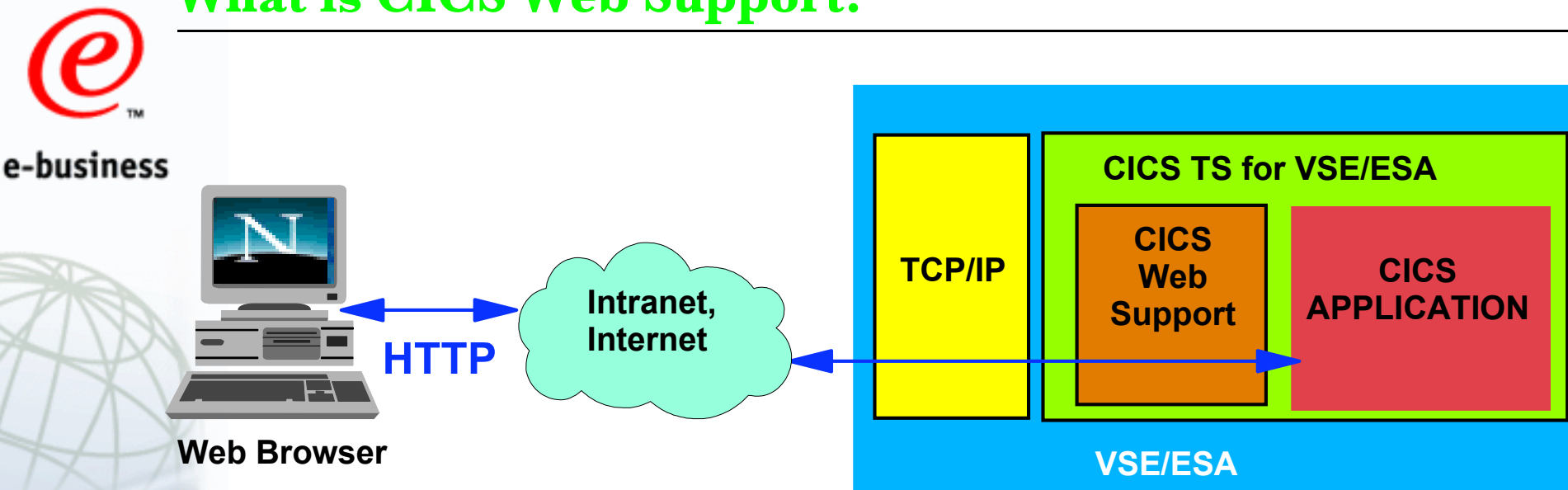

- Web browser access to CICS Applications and Transactions
- Direct connection - no intermediate gateways or servers
- Standard HTTP protocol used over TCP/IP

What is CICS Web Support?



e-business



Web Browser

HTTP

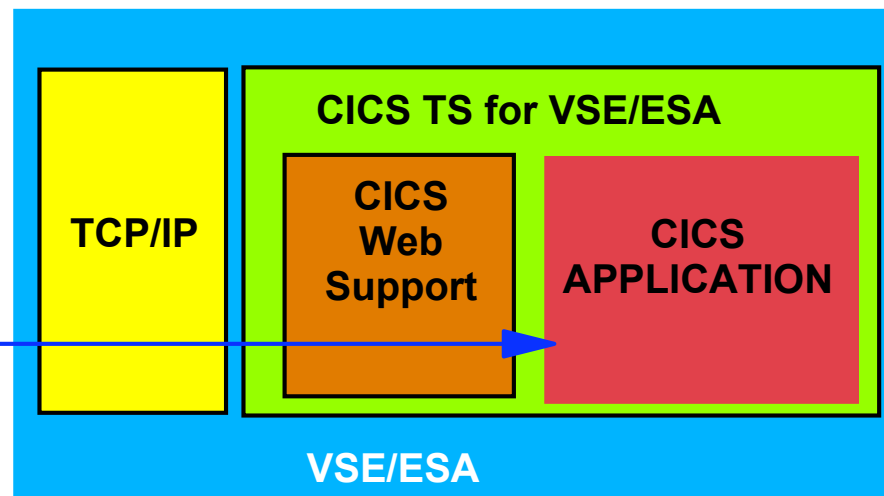
Intranet,
Internet

- Web browser access to CICS Applications and Transactions
- Direct connection - no intermediate gateways or servers
- Standard HTTP protocol used over TCP/IP
- Secure Sockets Layer (SSL) support coming
 - ▶ VSE/ESA V2.6

NEW!

IBM



What is CICS Web Support?



e-business

- CICS Application program to be invoked specified in URL
 - CICS supplied program for access to 3270-based transactions

- Default URL format:

- `http://hostid:port/converter/alias/program?optional-token`

hostid is the IP address or DNS name of the CICS region

port is the configured listening port number

converter is the name of the program for Decode & Encode processing

- "CICS" if no converter

alias is the transaction id of the alias transaction

- "CWBA" is the supplied alias

program is the name of the CICS application program to be invoked

optional-token is optional data to be passed with the request

- Example URL:

- `http://cicstest.ibm.com:1080/cics/cwba/webpgm1`

IBM

Relationship to the CICS Transaction Gateway

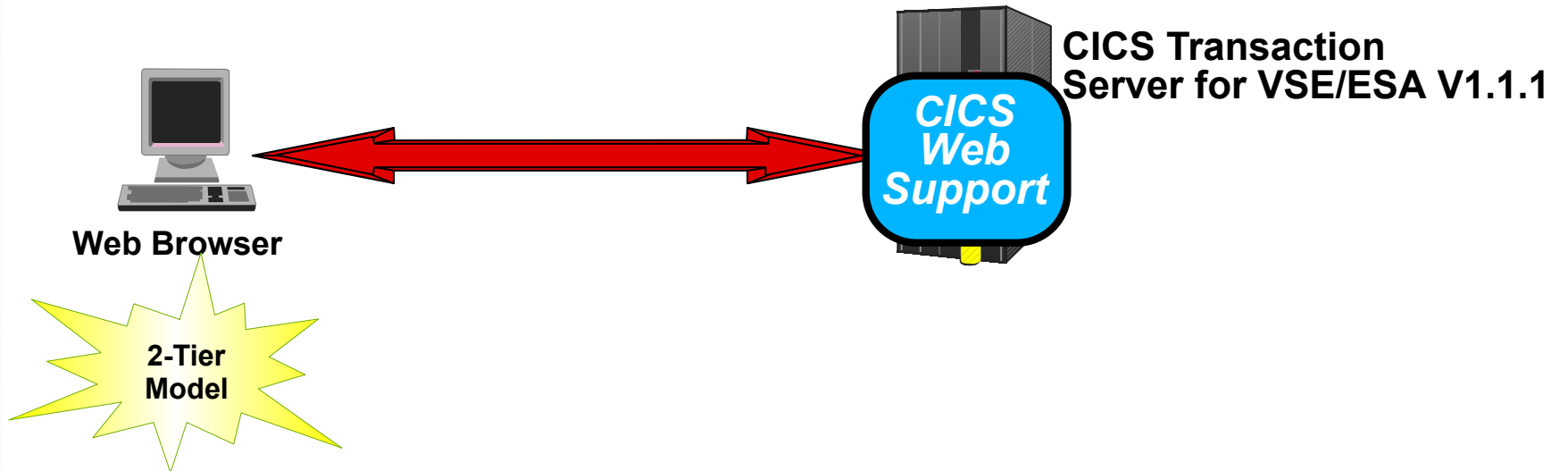
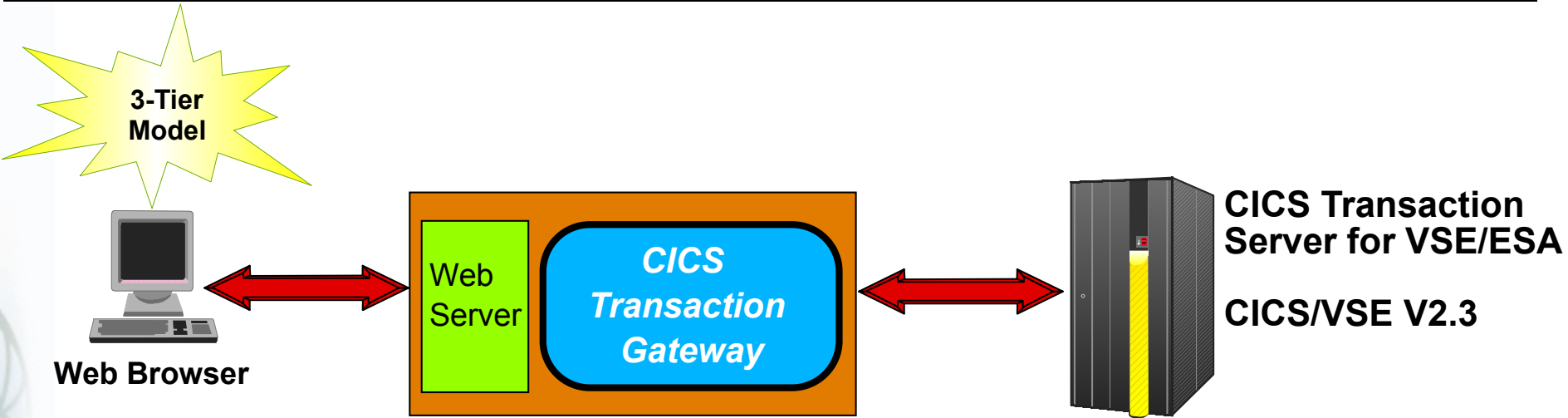

Agenda



e-business

- What is CICS Web Support?
- *CICS Web Support architecture*
- Enabling CICS Web Support
- Writing CICS Web Applications
- Running 3270-based transactions with CICS Web Support
- Further Information and Summary

The IBM logo, consisting of the letters 'IBM' in a bold, sans-serif font, positioned at the bottom left of the slide.

IBM



CICS Web Support Architecture...



e-business

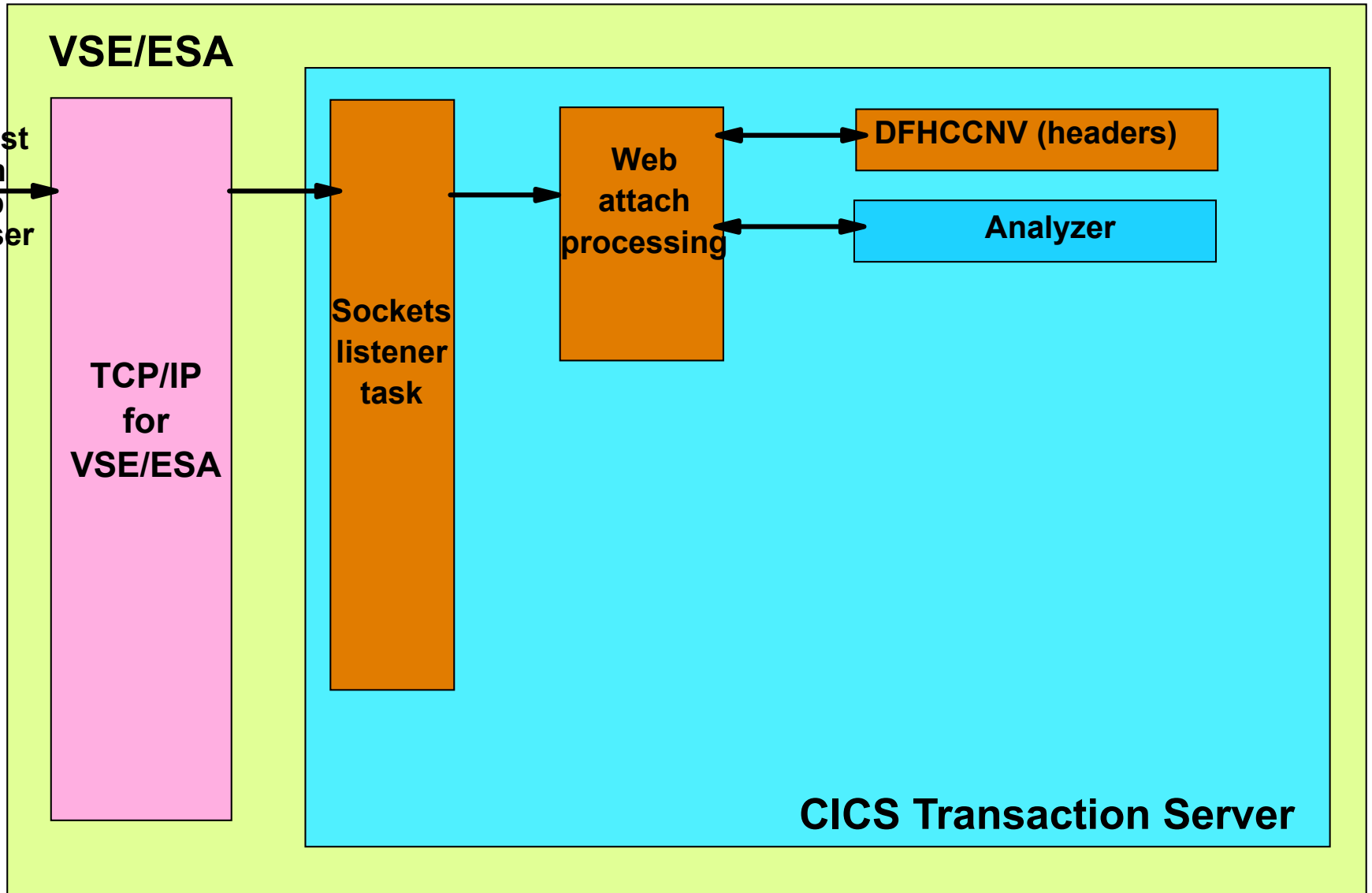

CICS Web Support Architecture...



e-business



www



IBM

■ The Analyzer:

- ▶ Parses the incoming request
- ▶ Determines resources and context for Alias transaction
- ▶ Specifies codepage conversion for body of http request
- ▶ User Replaceable Module

■ The supplied default Analyzer:

- ▶ Provides ISO-8859-01 codepage conversation
- ▶ Supports the default CWS URL format
 - <http://hostid:port/converter/alias/program?optional-token>

■ The supplied Analyzer programs:

- ▶ DFHWBADX -----> Assembler
- ▶ DFHWBAHX -----> C
- ▶ DFHWBALX -----> PL/I
- ▶ DFHWBAOX -----> COBOL

CICS Web Support Architecture...



e-business

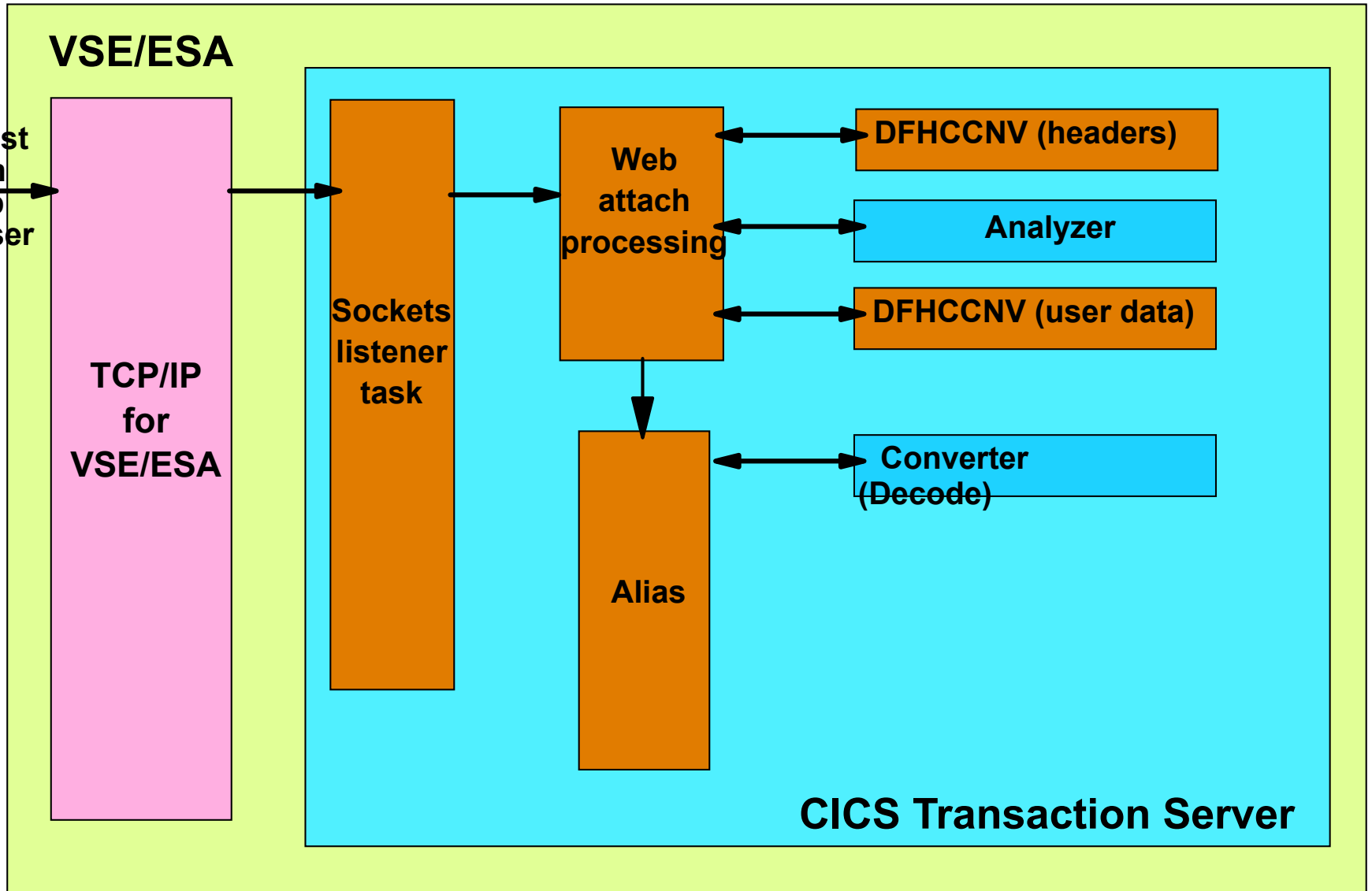

CICS Web Support Architecture...



e-business

■ The Converter

- ▶ Provides **Decode** and **Encode** functions
- **Decode** invoked *before* request passed to CICS application
 - ▶ Maps inbound HTTP request to application COMMAREA
- **Encode** invoked *after* CICS application has processed request
 - ▶ Maps application COMMAREA to outbound HTTP response

The IBM logo, consisting of the letters 'IBM' in a bold, sans-serif font, with a vertical line through the letters.

CICS Web Support Architecture...



e-business

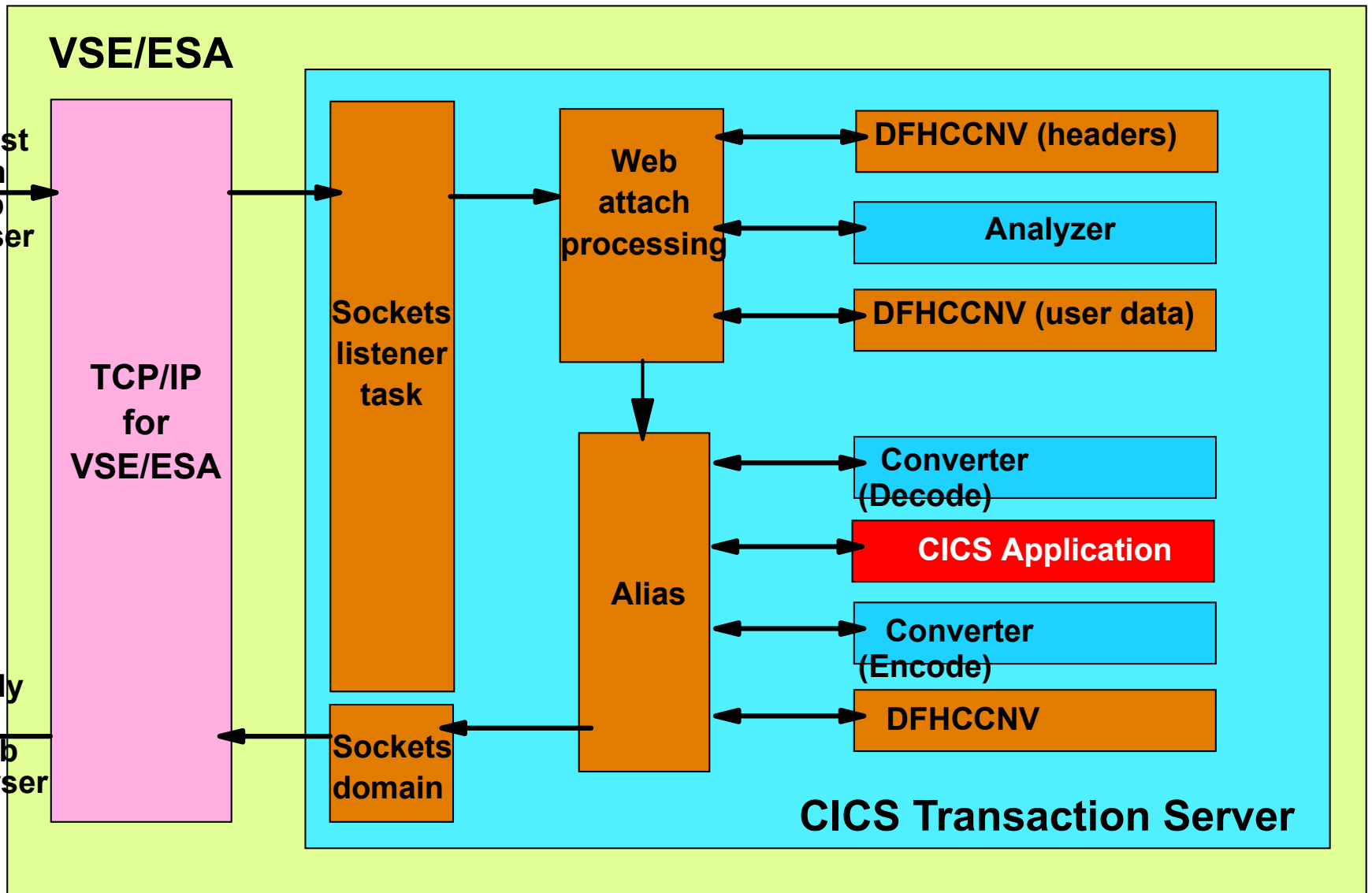

CICS Web Support Architecture...

Accessing existing COMMAREA based applications

- Converter used to shield applications from HTTP and HTML

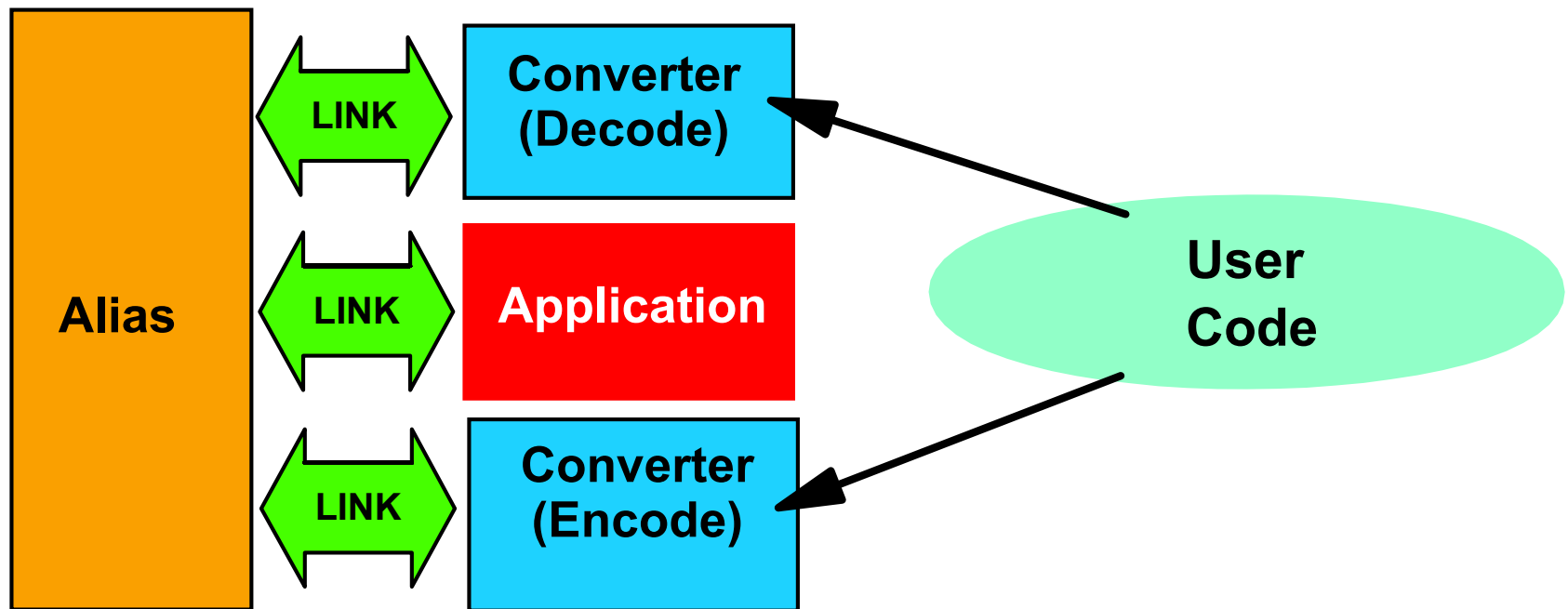

CICS Web Support Architecture...

Accessing new CICS "Web aware" Applications

- The picture becomes simpler using the new API's....

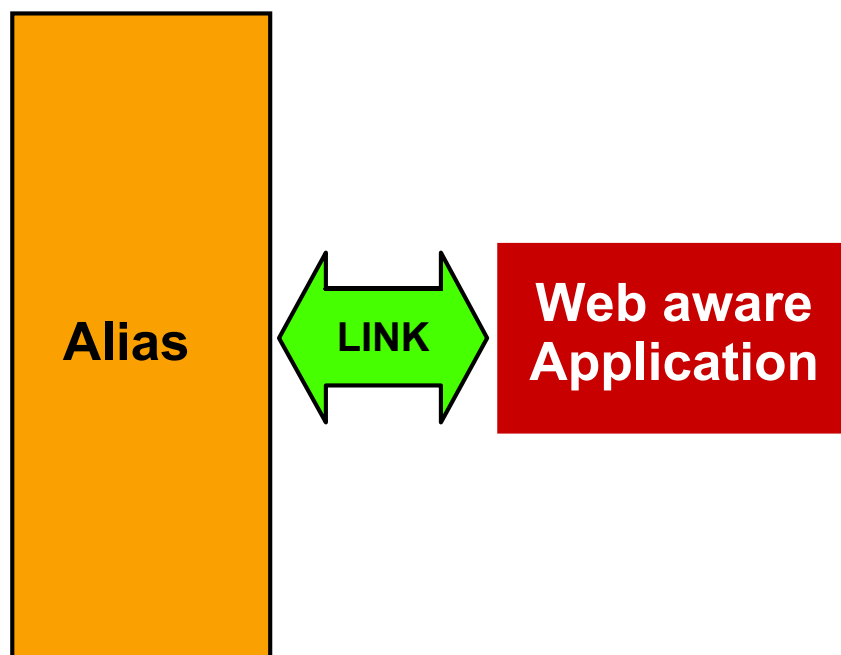

- NB: "Web aware" applications need to understand HTTP

CICS Web Support Architecture...

Accessing 3270 based transactions via the CICS Web Bridge

- Uses the 3270 Bridge support
- Some limitations - not every application may work unchanged

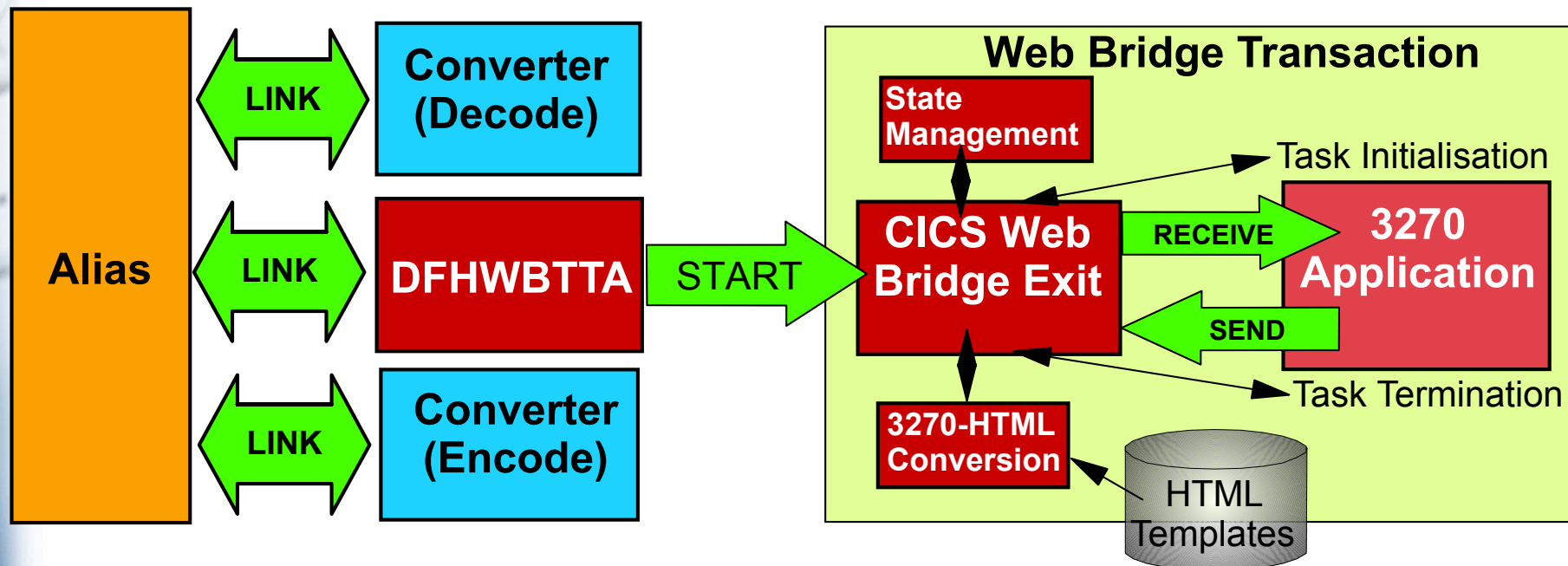

Example URL > <http://cics1.ibm.com:1080/cics/cwba/dfhwbtta/ceci>

Agenda



e-business

- What is CICS Web Support?
- CICS Web Support architecture
- *Enabling CICS Web Support*
- Writing CICS Web Applications
- Running 3270-based transactions with CICS Web Support
- Further Information and Summary

The IBM logo, consisting of the letters 'IBM' in a bold, sans-serif font, is positioned at the bottom left of the slide.

IBM



DFHSIT requirements



e-business

- Specify that TCP/IP services are required
 - ▶ TCPIP=YES

- Specify Web 3270 bridge parameters
 - ▶ WEBDELAY=(n,m)
 - *n = time a transaction is to remain in terminal wait before being terminated*
 - *m = time during which state data is kept for a transaction*

- Increase EDSA storage
 - ▶ by at least 2M for TCPIP services
 - ▶ 1M per active Web connection

The IBM logo, consisting of the letters 'IBM' in a bold, sans-serif font, with a blue and white striped background.

Resource Definitions



e-business

- Define at least one TCPIP SERVICE
 - Specifies IP address, port number, name of the analyzer
 - Sample specified in DFH\$SOT
- Install supplied RDO group DFHWEB
- Define any required DOCTEMPLATES
 - ▶ Definition specifies location of DOCTEMPLATE
 - VSE/ESA sub-library
 - CICS File
 - CICS Temporary Storage
 - CICS Transient Data
 - CICS Load Module
 - CICS Exit Program

IBM

Other Requirements



e-business

- Define a conversion table using DFHCNV macros
 - ▶ For conversion between ASCII and EBCDIC of HTTP messages
 - ▶ Example DFHCNV table:

```
DFHCNV TYPE=INITIAL
*
DFHCNV TYPE=ENTRY,RTYPE=PC,RNAME=DFHQBHH,USREXIT=NO,
      SRVERCP=037,CLINTCP=8859-1
DFHCNV TYPE=SELECT
DFHCNV TYPE=FIELD,OFFSET=0,DATATYP=CHARACTER,DATALEN=32767,
      LAST=YES
*
DFHCNV TYPE=ENTRY,RTYPE=PC,RNAME=DFHQBUD,USREXIT=NO,
      SRVERCP=037,CLINTCP=8859-1
DFHCNV TYPE=SELECT
DFHCNV TYPE=FIELD,OFFSET=0,DATATYP=CHARACTER,DATALEN=32767,
      LAST=YES
*
DFHCNV TYPE=FINAL
END
```

- Configure TCP/IP for VSE/ESA

IBM

Other Considerations



e-business

■ Security

- ▶ Transactions that compose CICS Web Support
- ▶ Running Web transactions with end-user specified Userid
- ▶ Use of Secure Sockets Layer (SSL)
- ▶ TCP/IP VSE/ESA security facilities

■ Operational Support

- ▶ DFHWBEP - Web Error Program
- ▶ SPI and CEMT commands

COMMAND	SPI	CEMT
CREATE DOCTEMPLATE	✓	
CREATE TCPIP SERVICE	✓	
DISCARD DOCTEMPLATE	✓	
DISCARD TCPIP SERVICE	✓	
INQUIRE DOCTEMPLATE	✓	✓
INQUIRE TCPIP	✓	✓
INQUIRE TCPIP SERVICE	✓	✓
INQUIRE WEB	✓	✓
SET TCPIP	✓	✓
SET TCPIP SERVICE	✓	✓
SET WEB	✓	✓

Agenda



e-business

- What is CICS Web Support?
- CICS Web Support architecture
- Enabling CICS Web Support
- *Writing CICS Web Applications*
- Running 3270-based transactions with CICS Web Support
- Further Information and Summary

The IBM logo, consisting of the letters 'IBM' in a bold, sans-serif font, is positioned at the bottom left of the slide.

IBM

The new Web API's



■ EXEC CICS WEB

- ▶ Retrieve components of the inbound HTTP request
- ▶ Construct HTTP headers to be returned in HTTP response
- ▶ Select a document for delivery as the body of the response

■ EXEC CICS EXTRACT

- ▶ Retrieve TCP information

■ EXEC CICS DOCUMENT

- ▶ Create and manipulate "Documents"
 - Can be made up of both text and binary elements
 - Can contain templates, symbols and bookmarks
 - Bookmarks can be used to insert data at specific points
 - Documents can be imbedded
 - Codepage information is stored with the Document

New WEB API's....Processing HTTP Requests



e-business

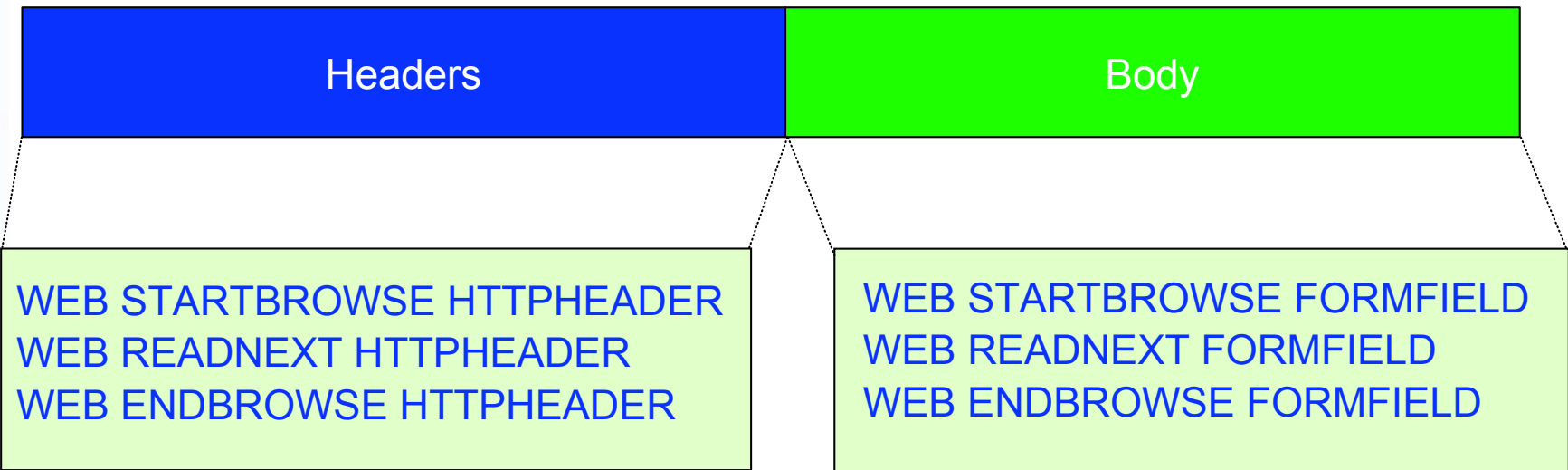
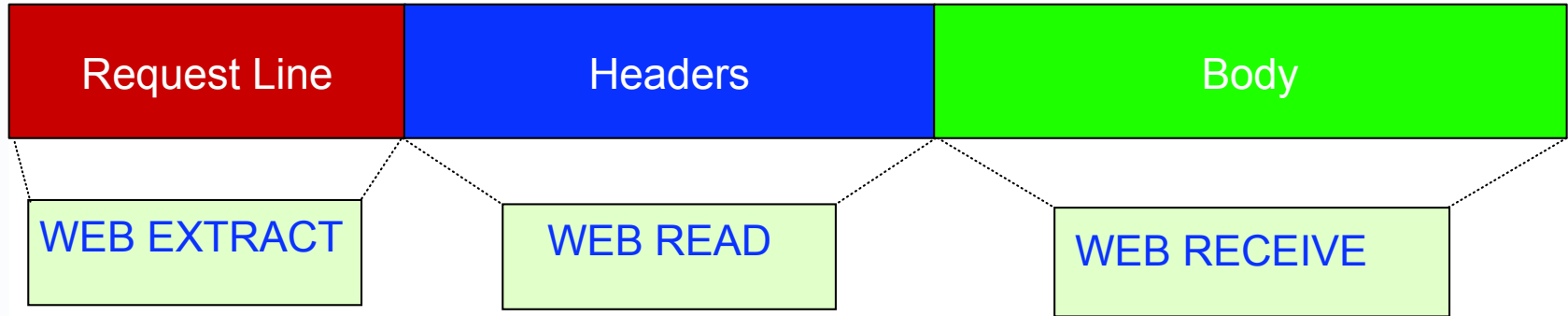

New WEB API's....Processing HTTP Responses

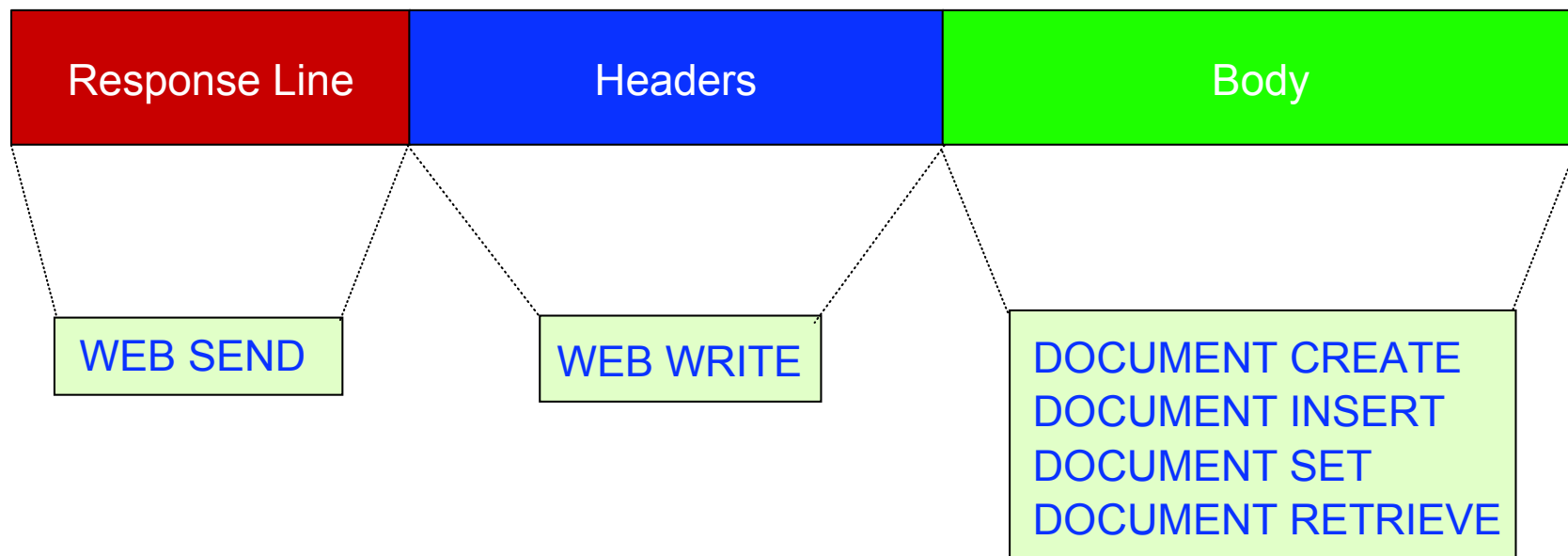

WEB RETRIEVE

used to retrieve a copy of the document specified on the last WEB SEND

Last WEB SEND determines document to be sent



Document Templates



e-business

- Document templates are defined via RDO

- HTML example:

```
<html>
<head>
<title>Address Book</title>
</head>
<body>
<center>
<h1>&person;</h1><br>
&house_number; &street;<br>
&town;<br>
&zip;<br>
&person; can be reached on &home_number; at home
or &work_number; during office hours <br>
</center>
</body>
</html>
```

- Example symbol list for the above would be a single string:
"person=Barney Rubble&house_number=2&street=Stoney
Lane&town=Bedrock&zip=&home_number=911&work_number=123-456 "
- Any editor can be used for templates

IBM

Document Templates...after substitution



e-business

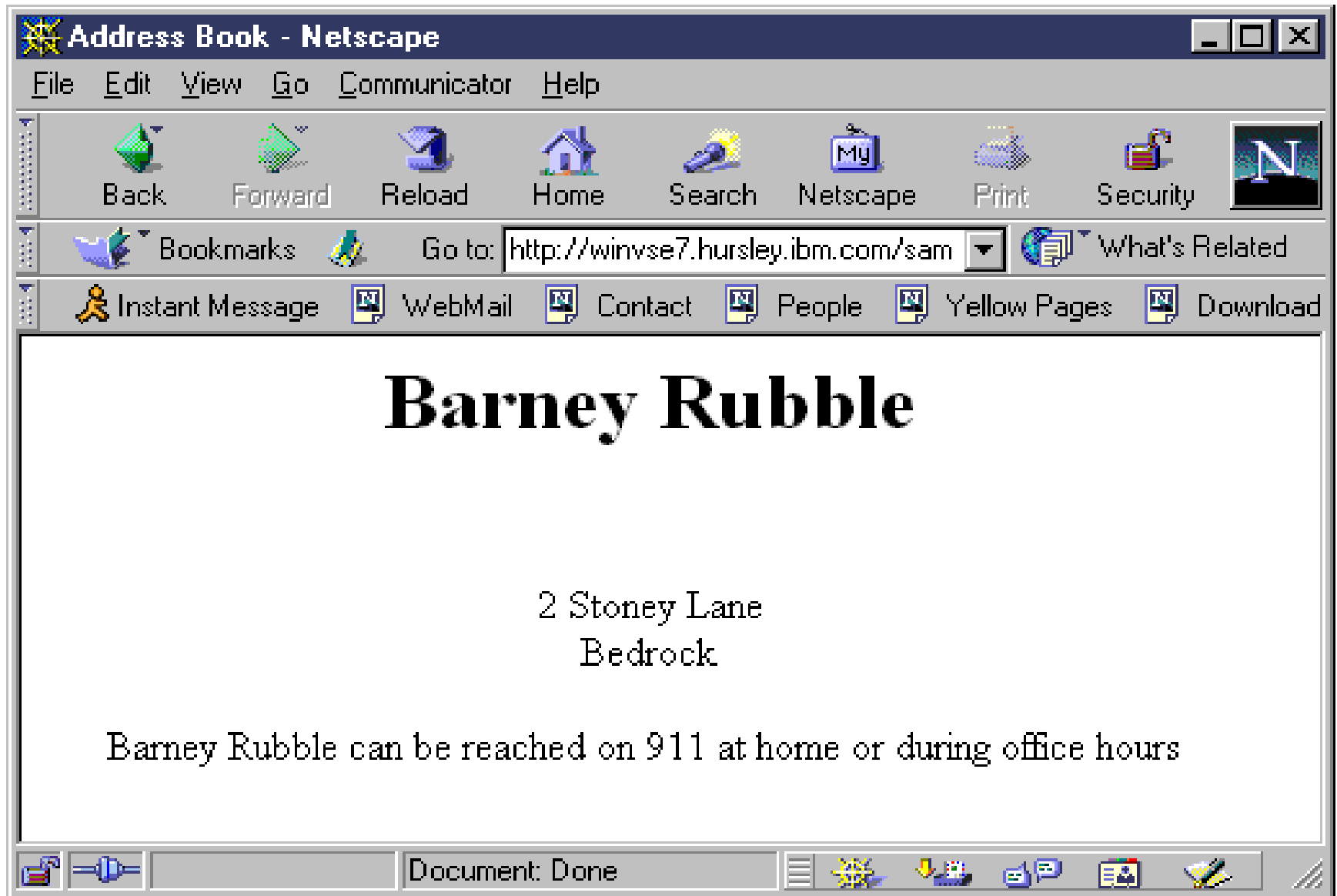

IBM

Web API's - Assembler code example

```

* Create document from existing HTML template
      EXEC CICS DOCUMENT CREATE DOCTOKEN(DOCTKN)
        TEMPLATE('TEMPL1')
* Get Server TCP/IP address
      EXEC CICS EXTRACT TCPIP
        SERVERADDR(SRVRADDR) SADDRLENGTH(ADDRL)
* Get Client TCP/IP address
      EXEC CICS EXTRACT TCPIP
        CLIENTADDR(CLNTADDR) CADDRLENGTH(ADDRL)
* Insert both addresses into document
      EXEC CICS DOCUMENT INSERT DOCTOKEN(DOCTKN)
        TEXT(DOCTXT) LENGTH(DOCTXTL)
* Add footer to document from existing HTML template
      EXEC CICS DOCUMENT INSERT DOCTOKEN(DOCTKN)
        TEMPLATE('TEMPL2')
* Send completed document
      EXEC CICS WEB SEND DOCTOKEN(DOCTKN) CLNTCODEPAGE('iso-8859-1')
* Terminate program
      EXEC CICS RETURN

ADDRL      DC F'15'
DOCTXTL    DC F'70'
DOCTKN     DC CL16
DOCTXT     DS 0CL
SRVRTXT    DC C'<p> Server Address: '
SRVRADDR   DS CL15
SRVRTXT    DC C'<p> Client Address: '
CLNTADDR   DS CL15

```



e-business



IBM

Web API's - Templates for code example



e-business

First HTML Template (TEMPL1)

```
<html>
<head>
<title>Simple CWS Demo</title>
</head>
<body>
<h1>Following info produced via the EXEC CICS EXTRACT, DOCUMENT and WEB API's</h1>
```

Second HTML Template (TEMPL2)

```
<p><hr>
<p>Foot of simple CICS Web Support API demo page
</body>
</html>
```

IBM

Agenda



e-business

- What is CICS Web Support
- CICS Web Support architecture
- Enabling CICS Web Support
- Writing CICS Web applications
- *Running 3270-based transactions with CICS Web Support*
- Further Information and Summary

The IBM logo, consisting of the letters 'IBM' in a bold, sans-serif font, is positioned at the bottom left of the slide.

IBM

Architecture



e-business

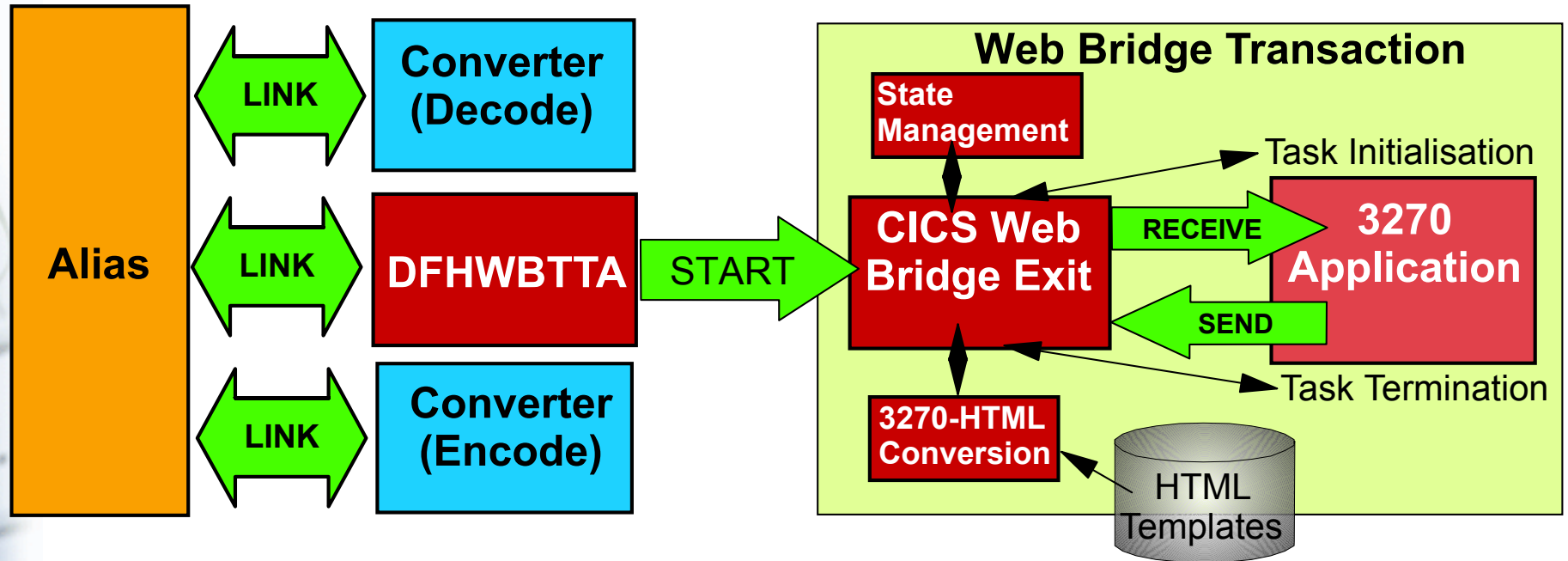

Example URL > <http://cics1.ibm.com:1080/cics/cwba/dfhwbtta/app1>



Creating HTML for BMS applications



e-business

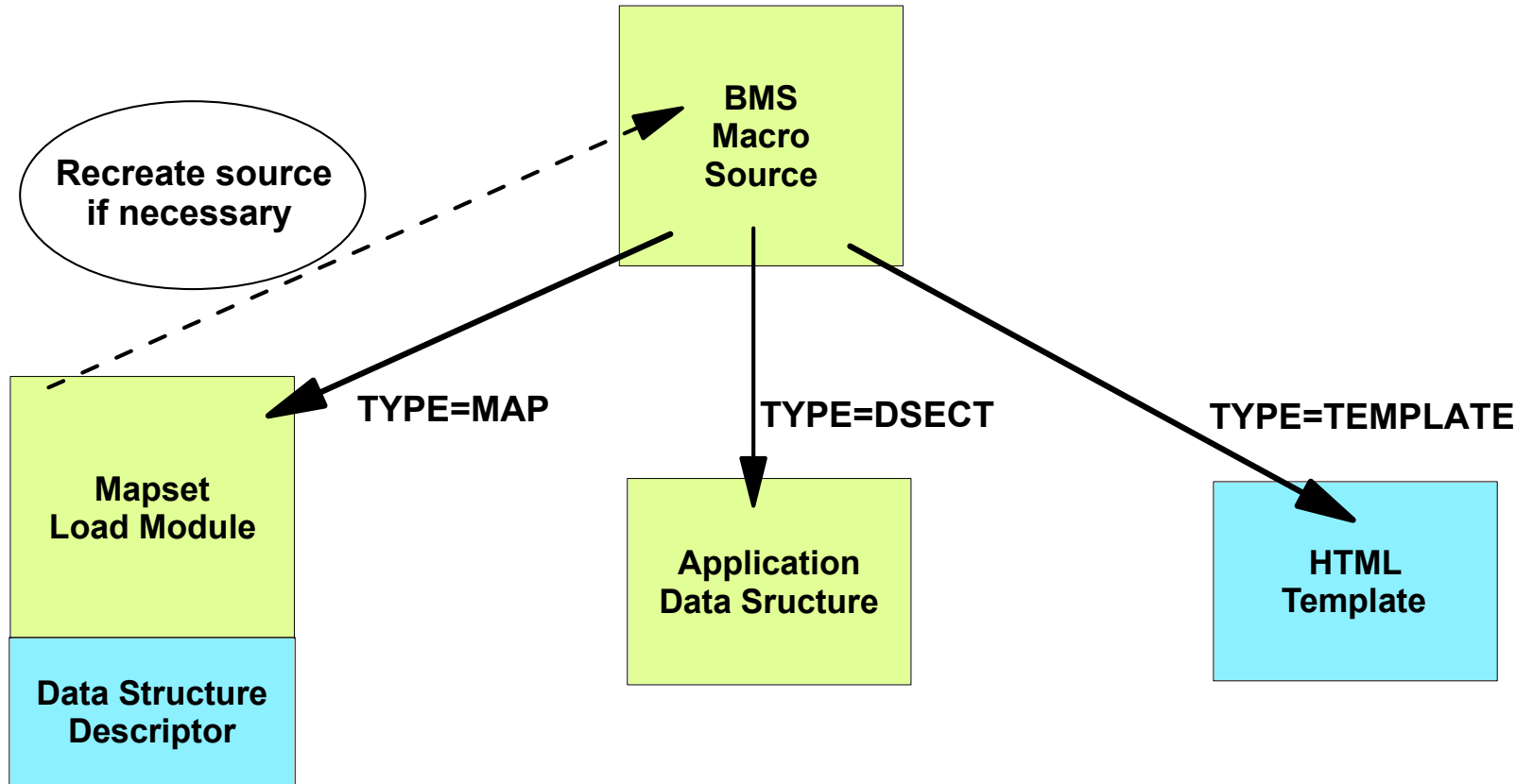
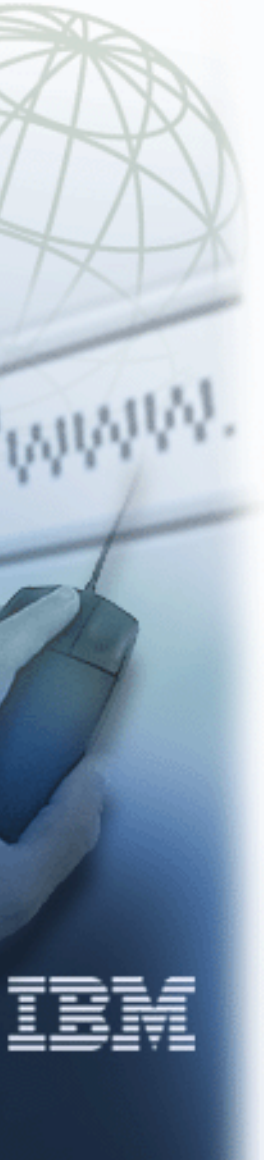

Creating HTML for BMS applications....

A template generated by the standard method contains...

- Constants and input fields from the map
- Buttons to represent:
 - ▶ ENTER key
 - ▶ PA1, PA2, PA3 keys
 - ▶ Program function keys PF1 to PF24
 - ▶ HTML Reset
- Hidden variables
 - ▶ For handling conversations/pseudoconversations
 - ▶ For holding name of map field where cursor is set
- JavaScript
 - ▶ Function to set the cursor position to a specific field
 - ▶ Exception handler for tracking cursor movement

Customising HTML for BMS applications



e-business

- Customise via CICS supplied macros
- Edit the generated HTML
- Run time customisation via use of Converter
 - ▶ Input (Decode)
 - e.g. change AID, change cursor position
 - ▶ Output (Encode)
 - e.g. Dynamically add or modify the HTML



Customising HTML for BMS applications....

Customising via the DFHMDX macro.....

- Defines customization macros used for template creation
- Is invoked from DFHMSX
- Can be used to
 - ▶ Support application use of keys not in the standard output
 - ▶ Suppress HTML Reset
 - ▶ Change the appearance of the keys, or associated text
 - ▶ Provide an HTML title or masthead graphic
 - ▶ Change the background
 - ▶ Modify BMS colours
 - ▶ Suppress parts of the BMS map
 - ▶ Add Web browser control functions, e.g. JavaScript



Customising HTML for BMS applications....

Customising via the DFHWBOUT macro

- Add invocations of DFHWBOUT to BMS source
- Can be used to
 - ▶ Add HTML header information
 - ▶ Add text to HTML page that is not part of BMS map
 - ▶ Add Web browser control functions, e.g. JavaScript



HTML for non-BMS applications

Default presentation...

- Page produced in fixed width font
- Supplied Headers and Footers
 - ▶ Mandatory HTML page elements
 - ▶ Input buttons (ENTER, PF Keys, etc)

Customisation...

- Provide replacement header and footer templates
- Use a converter for customisation at run time
 - ▶ Input (Decode)
 - e.g. change AID, change cursor position
 - ▶ Output (Encode)
 - e.g. Any dynamic HTML modification needed

3270-based transactions - current restrictions

- No dynamic modification of attribute bytes by BMS
- Multiple SEND MAPs for one screen not supported
- Cannot mix BMS and non-BMS SEND commands
- Structured fields not supported
- Lightpen emulation not supported
- Must use same map on a RECEIVE following a SEND
- BMS Paging not supported



Accessing Existing CICS Transactions...non-BMS

CICS Web Interface screen emulation - Netscape

File Edit View Go Communicator Help

Back Forward Reload Home Search Guide Print Security Stop

STATUS: ENTER ONE OF THE FOLLOWING

ABend	DEQ	INquire	REceive	STARTBr
ACquire	DISAble	ISSue	RELease	SUSpend
ADdress	DISCard	JournaL	RESEtbr	SYncpoint
ALlocate	DUMp	LIInk	RESYnc	Trace
ASKtime	ENABle	LOAd	RETRieve	UnloCk
ASSign	ENDbr	MONitor	RETUrN	VeriFy
BIF	ENQ	PERform	REWrite	WAIT
BUild	ENter	POInt	ROute	WAITCics
CANcel	EXtract	POP	SEND	WRITE
CHange	FEpi	POST	SET	WRITEQ
COLlect	FORMattime	PURge	SIGNOFF	Xctl
CONNect	FREE	PUSH	SIGNON	
CONVerse	FREEMain	Query	SPOOLClose	
CReate	GDs	READ	SPOOLOpen	
DELAy	GETmain	READNext	SPOOLRead	
DELETE	Handle	READPrev	SPOOLWrite	
DELETEQ	IGNore	READQ	START	

PF 1 HELP 2 HEX 3 END 4 EIB 5 VAR 6 USER 9 MSG

PF1 PF2 PF3 PF4 PF5 PF6 PF7 PF8 PF9 PF10 PF11 PF12
 PF13 PF14 PF15 PF16 PF17 PF18 PF19 PF20 PF21 PF22 PF23 PF24
 PA1 PA2 PA3 Clear Enter Pen Reset

Document Done

Accessing Existing CICS Applications...BMS

BMS application - default appearance.....

CICS Web Interface BMS screen emulation - Netscape

File Edit View Go Communicator Help

Back Forward Reload Home Search Guide Print Security Stop

CICS Web Interface BMS screen emulation

Share Trading Demonstration [TRADER.T001](#)

Share Trading Manager: Logon

Enter your User Name:

Enter your Password:

PF3=Exit PF12=Exit

PF1	PF2	PF3	PF4	PF5	PF6	PF7	PF8	PF9	PF10	PF11	PF12
PF13	PF14	PF15	PF16	PF17	PF18	PF19	PF20	PF21	PF22	PF23	PF24
PA1	PA2	PA3	Enter	Reset							

Document Done

Accessing Existing CICS Applications...BMS

BMS application - customised....



Share Select - Netscape

File Edit View Go Communicator Help

Bookmarks Location: <http://195.212.14.242:8184/CICS/CWBA/DFHWBTTA/trad> What's Related

Back Forward Reload Home Search Netscape Print Security Shop Stop

VSE-L Archive: Google IBM CICS : Over IBM BluePages IBM Intranet IBM VSE/ESA hom Yell BBC Radio 5 Liv BT PhoneNetUK -

Login Stage

Enter your User Name and Password, press submit to continue.

User Name:

Password:

Submit

For our French language investors we will shortly be offering a service in French.

Pour nos investisseurs de langue française nous offrirons bientôt un service en français.

Document: Done

Agenda



e-business

- What is CICS Web Support?
- CICS Web Support architecture
- Enabling CICS Web Support
- Writing CICS Web applications
- Running 3270-based transactions with CICS Web Support
- *Further Information and Summary*

The IBM logo, consisting of the letters 'IBM' in a bold, sans-serif font, is positioned at the bottom left of the slide. The background of the slide features a vertical strip on the left with a wireframe globe, a computer mouse, and a document with a URL, all in a light blue and white color scheme.

IBM

Further Information



■ Web Sites

- ▶ CICS (main site)
 - <http://www.ibm.com/software/cics>
- ▶ CICS Transaction Server for VSE/ESA
 - <http://www.ibm.com/software/cics/platforms/cicsvse/vse.html>
- ▶ CICS (SupportPacs)
 - <http://www.ibm.com/software/cics/txppacs/>
- ▶ VSE/ESA
 - <http://www.s390.ibm.com/vse>
- ▶ Red books
 - <http://www.redbooks.ibm.com>

■ Announcement Letters

- ▶ CICS Transaction Server for VSE/ESA V1.1.1: 200-293
- ▶ VSE/ESA V2.6 Preview: 201-097

Further Information....



■ Publications

e-business

Title	Number
IBM CICS Transaction Server for VSE/ESA product publications (V1.1.1)	
Internet Guide	SC34-5765
Enhancements Guide	GC34-5763
External Interfaces Guide	SC33-1669
IBM Red Books	
CICS Transaction Server for VSE/ESA: CICS Web Support	SG24-5997
Revealed! Architecting Web Access to CICS	SG24-5466
Getting Started with TCP/IP for VSE/ESA V1.4	SG24-5626
e-business Solutions for VSE/ESA	SG24-5662
VSE White Paper	
VSE Applications - How e-business fits	GF22-5137

- ▶ Accessible from the CICS and IBM Redbooks Web sites

Summary



e-business

- Access to CICS applications and transactions from Web Browsers
- Direct connection - no requirement for intermediate server
- Standard HTTP protocol used
- New APIs to enable creation of new Web aware applications
- Automatic HTML<->3270 conversion for existing applications
- Straightforward to configure and implement
- Delivered with CICS Transaction Server for VSE/ESA V1.1.1

The IBM logo, consisting of the letters 'IBM' in a bold, sans-serif font, is located in the bottom left corner of the slide.

IBM